

HENCO **PRODUCT OVERVIEW 2**



HENCO **PRODUCT OVERVIEW 2015/1**





Pipes	4	1
A. STANDARD (PE-Xc/AL/PE-Xc)	5	
B. RIXc (PE-Xc/AL/PE-Xc)	12	
C. FLOOR-RIXc (PE-Xc/AL/PE-Xc)	15	
D. PE-Xc	16	
E. PE-RT	17	
F. PROTECTION HOSE	18	
G. GAS STANDARD (PE-Xc/AL/PE-Xc)	19	
Henco Press	20	2
A. STANDARD	21	
B. GAS	38	
C. SUPER SIZE	44	
D. HENCO ECOLINE	50	
Henco Vision	52	3
A. FITTINGS	53	
B. MANIFOLDS	59	
Brass Press fittings	64	4
A. STANDARD	65	
B. GAS	79	
Brass Compression fittings	84	5
Manifolds	94	6
Valves	100	7
Underfloor heating	107	8
A. SYSTEMS	108	
B. MANIFOLDS	121	
C. CONTROL UNITS	133	
D. GEOTHERMAL	147	
Cabinets	148	9
Tools	150	10
Accessories	171	11
Certificates	175	

PIPES - BUIZEN - TUBES - ROHRE



	Page
A. STANDARD (PE-Xc/AL/PE-Xc)	5
B. RIXc (PE-Xc/AL/PE-Xc)	12
C. FLOOR-RIXc (PE-Xc/AL/PE-Xc)	15
D. PE-Xc	16
E. PE-RT	17
F. PROTECTION HOSE	18
G. GAS STANDARD (PE-Xc/AL/PE-Xc)	19



Type: COIL



Henco multilayer pipe (Coil)
 Henco meerlagenbuis (Rol)
 Henco tube multicouche (Rouleau)
 Henco Mehrschichtverbundrohr (Ring)

Article number	m/ Pallet	Type	Subgroup
100-121688 **	100 m/ 2600 m	12x1,6	
200-121688 **	200 m/ 3000 m	12x1,6	
50-140210 *	50 m/ 2000 m	14x2	1.14SFB
100-140210	100 m/ 2200 m	14x2	1.14SFB
200-140210	200 m/ 3000 m	14x2	1.14SFB
50-160212	50 m/ 1500 m	16x2	1.16SFB
100-160212	100 m/ 2200 m	16x2	1.16SFB
200-160212	200 m/ 2600 m	16x2	1.16SFB
500-160212D	500 m/ 2500 m	16x2	1.16SFB
100-180214	100 m/ 1700 m	18x2	1.18SFB
200-180214	200 m/ 2000 m	18x2	1.18SFB
25-200216	25 m/ 800 m	20x2	1.20SFB
50-200216	50 m/ 1000 m	20x2	1.20SFB
100-200216	100 m/ 1500 m	20x2	1.20SFB
50-260320	50 m/ 800 m	26x3	1.26SFB
50-320326	50 m/ 650 m	32x3	1.32SFB

* IDEAL FOR FUEL OIL ** 6 bar - 60°C

- 1
- 2
- 3
- 4
- 5
- 6
- 7
- 8
- 9
- 10
- 11

Type: COIL CSC



Henco multilayer pipe (Coil Small Core)
 Henco meerlagenbuis (Rol Kleine Kern)
 Henco tube multicouche (Petit Rouleau Noyau intérieure)
 Henco Mehrschichtverbundrohr (Ring kleinen Kern)

Article number	Pallet	Type	Subgroup
10-160212-KB	800 m	16x2	
15-160212-KB	900 m	16x2	
25-160212-KB	1125 m	16x2	
25-200216-KB	900 m	20x2	

ID Coil: 28cm



A. STANDARD (PE-Xc /AL/PE-Xc)

Type: STRAIGHT LENGTH



Henco multilayer pipe (Straight length)
 Henco meerlagenbuis (Stang)
 Henco tube multicouche (Barre)
 Henco Mehrschichtverbundrohr (Stange)

Article number	Cylinder / Pallet	Type	Subgroup
03-160212	75 m / 3600 m	16x2	2.16SPB
04-160212	100 m / 4800 m	16x2	2.16SPB
05-160212	125 m / 6000 m	16x2	2.16SPB
03-180214	60 m / 2880 m	18x2	2.18SPB
04-180214	80 m / 3840 m	18x2	2.18SPB
05-180214	100 m / 4800 m	18x2	2.18SPB
03-200216	54 m / 2592 m	20x2	2.20SPB
04-200216	72 m / 3456 m	20x2	2.20SPB
05-200216	90 m / 4320 m	20x2	2.20SPB
03-260320	30 m / 1440 m	26x3	2.26SPB
04-260320	40 m / 1920 m	26x3	2.26SPB
05-260320	50 m / 2400 m	26x3	2.26SPB
03-320326	21 m / 1008 m	32x3	2.32SPB
04-320326	28 m / 1344 m	32x3	2.32SPB
05-320326	35 m / 1680 m	32x3	2.32SPB
03-403533	27 m / 648 m	40x3,5	2.40SPB
04-403533	36 m / 864 m	40x3,5	2.40SPB
05-403533	45 m / 1080 m	40x3,5	2.40SPB
03-504042	21 m / 504 m	50x4	2.50SPB
04-504042	28 m / 672 m	50x4	2.50SPB
05-504042	35 m / 840 m	50x4	2.50SPB
03-634554	12 m / 288 m	63x4,5	2.63SPB
04-634554	16 m / 384 m	63x4,5	2.63SPB
05-634554	20 m / 480 m	63x4,5	2.63SPB
05-756063	10 m / 48 m	75x6	2.75SPB
05-907076	5 m / 48 m	90x7	2.90SPB



Type: ISO4 (6 mm)



Pre-insulated (Coil)
Voorgeïsoleerd (Rol)
Pré-isolé (Rouleau)
Isoliert (Ring)

Article number	m/ Pallet	Type	Subgroup
100-ISO4-14-RO	100 m/ 1300 m	14x2 red	1.14S4 P
100-ISO4-14-BL	100 m/ 1300 m	14x2 blue	1.14S4 P
100-ISO4-16-RO	100 m/ 1300 m	16x2 red	1.16S4 P
100-ISO4-16-BL	100 m/ 1300 m	16x2 blue	1.16S4 P
50-ISO4-18-RO	50 m/ 650 m	18x2 red	1.18S4 P
50-ISO4-18-BL	50 m/ 650 m	18x2 blue	1.18S4 P
50-ISO4-20-RO	50 m/ 700 m	20x2 red	1.20S4 P
50-ISO4-20-BL	50 m/ 700 m	20x2 blue	1.20S4 P
25-ISO4-26-RO	25 m/ 300 m	26x3 red	1.26S4 P
25-ISO4-26-BL	25 m/ 300 m	26x3 blue	1.26S4 P
50-ISO4-26-RO	50 m/ 500 m	26x3 red	1.26S4 P
50-ISO4-26-BL	50 m/ 500 m	26x3 blue	1.26S4 P
25-ISO4-32-RO	25 m/ 300 m	32x3 red	1.32S4 P
25-ISO4-32-BL	25 m/ 300 m	32x3 blue	1.32S4 P

1

2

3

4

5

6

7

8

9

10

11

Type: ISO9 (10 mm)



Pre-insulated (Coil)
Voorgeïsoleerd (Rol)
Pré-isolé (Rouleau)
Isoliert (Ring)

Article number	m/ Pallet	Type	Subgroup
50-ISO9-14-RO	50 m/ 600 m	14x2 red	2.14S9 P
50-ISO9-14-BL	50 m/ 600 m	14x2 blue	2.14S9 P
50-ISO9-16-RO	50 m/ 550 m	16x2 red	2.16S9 P
50-ISO9-16-BL	50 m/ 550 m	16x2 blue	2.16S9 P
50-ISO9-18-RO	50 m/ 650 m	18x2 red	2.18S9 P
50-ISO9-18-BL	50 m/ 650 m	18x2 blue	2.18S9 P
50-ISO9-20-RO	50 m/ 500 m	20x2 red	2.20S9 P
50-ISO9-20-BL	50 m/ 500 m	20x2 blue	2.20S9 P
25-ISO9-26-RO	25 m/ 275 m	26x3 red	2.26S9 P
25-ISO9-26-BL	25 m/ 275 m	26x3 blue	2.26S9 P
50-ISO9-26-RO	50 m/ 400 m	26x3 red	2.26S9 P
50-ISO9-26-BL	50 m/ 400 m	26x3 blue	2.26S9 P
25-ISO9-32-RO	25 m/ 250 m	32x3 red	2.32S9 P
25-ISO9-32-BL	25 m/ 250 m	32x3 blue	2.32S9 P



A. STANDARD (PE-Xc /AL/PE-Xc)

Type: ISO13 (13 mm)



Pre-insulated (Coil)
Voorgeïsoleerd (Rol)
Pré-isolé (Rouleau)
Isolierd (Ring)

Article number	m/ Pallet	Type	Subgroup
50-ISO13-16-BL	50 m/ 400 m	16x2 blue	3.16S13 P
50-ISO13-18-BL	50 m/ 400 m	18x2 blue	3.16S13 P
50-ISO13-20-BL	50 m/ 400 m	20x2 blue	3.20S13 P
50-ISO13-26-BL	50 m/ 400 m	26x3 blue	3.26S13 P
25-ISO13-32-BL	25 m/ 250 m	32x3 blue	3.32S13 P

Type: ISO-EXZ13 (13 mm under, 6 mm above)



Pre-insulated eccentrically, 50% EnEv 2002 (Coil)
Voorgeïsoleerd excentrisch, 50% EnEv 2002 (Rol)
Pré-isolé excentrique (Rouleau)
Isolierd exzentrisch, 50% EnEv 2002 (Ring)

Article number	m/ Pallet	Type	Subgroup
50-ISO13-E16-BL	50 m/ 500 m	16x2 blue	3.16S13 P
50-ISO13-E18-BL	50 m/ 500 m	18x2 blue	3.16S13 P
25-ISO13-E20-BL	25 m/ 250 m	20x2 blue	3.20S13 P
25-ISO13-E26-BL	25 m/ 225 m	26x3 blue	3.26S13 P

TILL EXHAUSTION OF STOCK

Type: ISO-EXZ26 (26 mm under, 6 mm above)



Pre-insulated eccentrically, 100% EnEv 2002 (Coil)
Voorgeïsoleerd excentrisch, 100% EnEv 2002 (Rol)
Pré-isolé excentrique (Rouleau)
Isolierd exzentrisch, 100% EnEv 2002 (Ring)

Article number	m/ Pallet	Type	Subgroup
25-ISO26-E16-BL	25 m/ 200 m	16x2 blue	4.16S26 P
25-ISO26-E20-BL	25 m/ 200 m	20x2 blue	4.20S26 P
25-ISO26-E26-BL	25 m/ 200 m	26x3 blue	4.26S26 P

TILL EXHAUSTION OF STOCK



Type: STANDARD PIPE IN PIPE



With colour coded conduit (Coil)
 Met mantel (Rol)
 Avec gaine (Rouleau)
 Mit Mantel (Ring)

Article number	m/ Pallet	Type	Subgroup
25-014MR	25 m/ 800 m	14x2 red	1.14STPP
25-014MB	25 m/ 800 m	14x2 blue	1.14STPP
25-014MBLACK	25 m/ 800 m	14x2 black	1.14STPP
50-014MR	50 m/ 800 m	14x2 red	1.14STPP
50-014MB	50 m/ 800 m	14x2 blue	1.14STPP
50-014MBLACK	50 m/ 800 m	14x2 black	1.14STPP
100-014MR	100 m/ 1000 m	14x2 red	1.14STPP
100-014MB	100 m/ 1000 m	14x2 blue	1.14STPP
100-014MBLACK	100 m/ 1000 m	14x2 black	1.14STPP
25-016MR	25 m/ 500 m	16x2 red	1.16STPP
25-016MB	25 m/ 500 m	16x2 blue	1.16STPP
50-016MR	50 m/ 800 m	16x2 red	1.16STPP
50-016MB	50 m/ 800 m	16x2 blue	1.16STPP
50-016MBLACK	50 m/ 800 m	16x2 black	1.16STPP
100-016MR	100 m/ 1000 m	16x2 red	1.16STPP
100-016MB	100 m/ 1000 m	16x2 blue	1.16STPP
100-016MBLACK	100 m/ 1000 m	16x2 black	1.16STPP
50-018MR	50 m/ 800 m	18x2 red	1.18STPP
50-018MB	50 m/ 800 m	18x2 blue	1.18STPP
50-018MBLACK	50 m/ 800 m	18x2 black	1.18STPP
100-018MR	100 m/ 1000 m	18x2 red	1.18STPP
100-018MB	100 m/ 1000 m	18x2 blue	1.18STPP
100-018MBLACK	100 m/ 1000 m	18x2 black	1.18STPP
25-020MR	25 m/ 500 m	20x2 red	1.20STPP
25-020MB	25 m/ 500 m	20x2 blue	1.20STPP
25-020MBLACK	25 m/ 500 m	20x2 black	1.20STPP
50-020MR	50 m/ 800 m	20x2 red	1.20STPP
50-020MB	50 m/ 800 m	20x2 blue	1.20STPP
50-020MBLACK	50 m/ 800 m	20x2 black	1.20STPP
100-020MB	100 m/ 1000 m	20x2 blue	1.20STPP
100-020MR	100 m/ 1000 m	20x2 red	1.20STPP
25-026MR	25 m/ 500 m	26x3 red	1.26STPP
25-026MB	25 m/ 500 m	26x3 blue	1.26STPP
50-026MR	50 m/ 500 m	26x3 red	1.26STPP
50-026MB	50 m/ 500 m	26x3 blue	1.26STPP
50-026MBLACK	50 m/ 500 m	26x3 black	1.26STPP
25-032MR	25 m/ 400 m	32x3 red	1.32STPP
25-032MB	25 m/ 400 m	32x3 blue	1.32STPP
25-032MBLACK	25 m/ 400 m	32x3 black	1.32STPP

1

2

3

4

5

6

7

8

9

10

11



A. STANDARD (PE-X_c/AL/PE-X_c)

Type: COMBI STANDARD



Henco Combi (Coil)
Henco Combi (Rol)
Henco Combi (Rouleau)
Henco Combi (Ring)

Article number	m/ Pallet	Type	Subgroup
50-COMBI14	50 m/ 500 m	14x2	2.14STPP
50-COMBI16	50 m/ 500 m	16x2	2.16STPP

Type: STANDARD PIPE IN PIPE CSC



With colour coded conduit (Coil Small Core)
Met mantel (Rol Kleine Kern)
Avec gaine (Petit Rouleau Noyau intérieure)
Mit Mantel (Ring kleinen Kern)

Article number	Pallet	Type	Subgroup
25-016MB-KB	600 m	16x2	
25-016MR-KB	600 m	16x2	

ID Coil: 28cm

Type: LB



Henco carcassing pipe Ø 16
Dubbele radiatorbocht Henco buis Ø 16, doorverbonden einde
Double courbe radiateur, tube Henco Ø 16, embout fermé
Heizkörperwinkel doppelt, Henco Rohr Ø 16, durchgestellt Ende

Article number	m	Type	Subgroup
LB45	1 m	45 mm	
LB50	1 m	50 mm	

Type: ISO-BLOCK-S



Henco carcassing pipe Ø 16 with insulation
Dubbele radiatoraansluitbocht met isolatie, Ø 16, doorverbonden einde
Double courbe radiateur, Ø 16, avec isolation, embout fermé
Heizkörperwinkel doppelt mit Isolation, Ø 16, durchgestellt Ende

Article number	m	Type	Subgroup
ISO-BLOCK-S	1 m	ISO-BLOCK-S	

TILL EXHAUSTION OF STOCK



Type: ISO-BLOCK-L



Henco carcassing pipe Ø 16 with insulation
 Dubbele radiator aansluitbocht met isolatie, Ø 16, doorverbonden einde
 Double courbe radiateur, Ø 16, avec isolation, embout fermé
 Heizkörperwinkel doppelt mit Isolation, Ø 16, durchgestellt Ende

Article number	m	Type	Subgroup
ISO-BLOCK-L	1 m	ISO-BLOCK-L	

- 1
- 2
- 3
- 4
- 5
- 6
- 7
- 8
- 9
- 10
- 11



B. RIXc (PE-Xc/AL/PE-Xc)

Type: COIL



Henco multilayer pipe RIXc (Coil)
 Henco meerlagenbuis RIXc (Rol)
 Henco tube multicouche RIXc (Rouleau)
 Henco Merschichtverbundrohr RIXc (Ring)

Article number	m/ Pallet	Type	Subgroup
50-R160212	50 m/ 1500 m	16x2	1.16RFB
100-R160212	100 m/ 2200 m	16x2	1.16RFB
200-R160212	200 m/ 2600 m	16x2	1.16RFB
500-R160212	500 m/ 2500 m	16x2	1.16RFB
100-R180214	100 m/ 1700 m	18x2	1.18RFB
200-R180214	200 m/ 2000 m	18x2	1.18RFB
100-F200216	100 m/ 1500 m	20x2	1.20RFB
50-F260320	50 m/ 800 m	26x3	1.26RFB

Type: COIL CSC



Henco multilayer pipe RIXc (Coil Small Core)
 Henco meerlagenbuis RIXc (Rol Kleine Kern)
 Henco tube multicouche RIXc (Rouleau Petit Noyau)
 Henco Merschichtverbundrohr RIXc (Ring kleinen Kern)

Article number	Pallet	Type	Subgroup
10-R160212-KB	800 m	16x2	
15-R160212-KB	900 m	16x2	
25-R160212-KB	1125 m	16x2	

ID Coil: 28cm

Type: STRAIGHT LENGTH



Henco multilayer pipe RIXc (Straight length)
 Henco meerlagenbuis RIXc (Stang)
 Henco tube multicouche RIXc (Barre)
 Henco Merschichtverbundrohr RIXc (Stange)

Article number	Cylinder	Type	Subgroup
03-R160212	75 m/ 3600 m	16x2	2.16RPB
04-R160212	100 m/ 4800 m	16x2	2.16RPB
05-R160212	125 m/ 6000 m	16x2	2.16RPB
03-R180214	60 m/ 2880 m	18x2	2.18RPB
04-R180214	80 m/ 3840 m	18x2	2.18RPB
05-R180214	100 m/ 4800 m	18x2	2.18RPB
03-F200216	54 m/ 2592 m	20x2	2.20RPB
04-F200216	72 m/ 3456 m	20x2	2.20RPB
05-F200216	90 m/ 4320 m	20x2	2.20RPB
03-F260320	30 m/ 1440 m	26x3	2.26RPB
04-F260320	40 m/ 1920 m	26x3	2.26RPB
05-F260320	50 m/ 2400 m	26x3	2.26RPB



Type: ISO4 (6 mm)



RIX_c Pre-insulated (Coil)
 RIX_c Voorgeïsoleerd (Rol)
 RIX_c Pré-isolé (Rouleau)
 RIX_c Isoliert (Ring)

Article number	m/ Pallet	Typ	Subgroup
100-ISO4-R16-RO	100 m/ 1300 m	16x2 red	1.16R4 P
100-ISO4-R16-BL	100 m/ 1300 m	16x2 blue	1.16R4 P
50-ISO4-R18-RO	50 m/ 650 m	18x2 red	1.18R4 P
50-ISO4-R18-BL	50 m/ 650 m	18x2 blue	1.18R4 P
50-ISO4-R20-RO	50 m/ 700 m	20x2 red	1.20R4 P
50-ISO4-R20-BL	50 m/ 700 m	20x2 blue	1.20R4 P
25-ISO4-R26-RO	25 m/ 300 m	26x3 red	1.26R4 P
25-ISO4-R26-BL	25 m/ 300 m	26x3 blue	1.26R4 P
50-ISO4-R26-RO	50 m/ 500 m	26x3 red	1.26R4 P
50-ISO4-R26-BL	50 m/ 500 m	26x3 blue	1.26R4 P

Type: ISO9 (10 mm)



RIX_c Pre-insulated (Coil)
 RIX_c Voorgeïsoleerd (Rol)
 RIX_c Pré-isolé (Rouleau)
 RIX_c Isoliert (Ring)

Article number	m/ Pallet	Typ	Subgroup
50-ISO9-R16-RO	50 m/ 650 m	16x2 red	2.16R9 P
50-ISO9-R16-BL	50 m/ 650 m	16x2 blue	2.16R9 P
50-ISO9-R18-RO	50 m/ 650 m	18x2 red	2.18R9 P
50-ISO9-R18-BL	50 m/ 650 m	18x2 blue	2.18R9 P
50-ISO9-R20-RO	50 m/ 500 m	20x2 red	2.20R9 P
50-ISO9-R20-BL	50 m/ 500 m	20x2 blue	2.20R9 P
25-ISO9-R26-RO	25 m/ 275 m	26x3 red	2.26R9 P
25-ISO9-R26-BL	25 m/ 275 m	26x3 blue	2.26R9 P

Type: ISO13 (13 mm)



RIX_c Pre-insulated (Coil)
 RIX_c Voorgeïsoleerd (Rol)
 RIX_c Pré-isolé (Rouleau)
 RIX_c Isoliert (Ring)

Article number	m/ Pallet	Typ	Subgroup
50-ISO13-R16-BL	50 m/ 400 m	16x2 blue	3.16R13 P
50-ISO13-R20-BL	50 m/ 400 m	20x2 blue	3.20R13 P
50-ISO13-R26-BL	50 m/ 400 m	26x3 blue	3.26R13 P

1

2

3

4

5

6

7

8

9

10

11



B. RIXc (PE-Xc/AL/PE-Xc)

- 1
- 2
- 3
- 4
- 5
- 6
- 7
- 8
- 9
- 10
- 11

Type: RIXc PIPE IN PIPE



RIXc With colour coded conduit (Coil)
 RIXc Met mantel (Rol)
 RIXc Avec gaine (Rouleau)
 RIXc Mit Mantel (Ring)

Article number	m/ Pallet	Type	Subgroup
25-R16MR	25 m/ 500 m	16x2 red	1.16RIPP
25-R16MB	25 m/ 500 m	16x2 blue	1.16RIPP
25-R16BLACK	25 m/ 500 m	16x2 black	1.16RIPP
50-R16MR	50 m/ 800 m	16x2 red	1.16RIPP
50-R16MB	50 m/ 800 m	16x2 blue	1.16RIPP
50-R16BLACK	50 m/ 800 m	16x2 black	1.16RIPP
100-R16MR	100 m/ 1000 m	16x2 red	1.16RIPP
100-R16MB	100 m/ 1000 m	16x2 blue	1.16RIPP
100-R16BLACK	100 m/ 1000 m	16x2 black	1.16RIPP
50-R18MR	50 m/ 800 m	18x2 red	1.18RIPP
50-R18MB	50 m/ 800 m	18x2 blue	1.18RIPP
50-R18BLACK	50 m/ 800 m	18x2 black	1.18RIPP
100-R18MR	100 m/ 1000 m	18x2 red	1.18RIPP
100-R18MB	100 m/ 1000 m	18x2 blue	1.18RIPP
100-R18BLACK	100 m/ 1000 m	18x2 black	1.18RIPP
25-F20MR	25 m/ 500 m	20x2 red	1.20RIPP
25-F20MB	25 m/ 500 m	20x2 blue	1.20RIPP
25-F20BLACK	25 m/ 800 m	20x2 black	1.20RIPP
50-F20MR	50 m/ 800 m	20x2 red	1.20RIPP
50-F20MB	50 m/ 800 m	20x2 blue	1.20RIPP
50-F20BLACK	50 m/ 800 m	20x2 black	1.20RIPP
100-F20MR	100 m/ 1000 m	20x2 red	1.20RIPP
100-F20MB	100 m/ 1000 m	20x2 blue	1.20RIPP
100-F20BLACK	100 m/ 1000 m	20x2 black	1.20RIPP
50-F26MR	50 m/ 500 m	26x3 red	1.26RIPP
50-F26MB	50 m/ 500 m	26x3 blue	1.26RIPP
50-F26BLACK	50 m/ 500 m	26x3 black	1.26RIPP

Type: COMBI RIXc



Henco Combi (Coil)
 Henco Combi (Rol)
 Henco Combi (Rouleau)
 Henco Combi (Ring)

Article number	m/ Pallet	Type	Subgroup
50-COMBI16R	50 m/ 500 m	16x2	2.16RIPP



Type: FLOOR-RIXc



Henco multilayer pipe (Coil)
 Henco meerlagenbuis (Rol)
 Henco tube multicouche (Rouleau)
 Henco Mehrschichtverbundrohr (Ring)

Article number	m/ Pallet	Type	Subgroup
100-F16R	100 m/ 2200 m	16x2	
200-F16R	200 m/ 2600 m	16x2	
500-F16R	500 m/ 2500 m	16x2	
100-F20R	100 m/ 1000 m	20x2	
200-F20R	200 m/ 1000 m	20x2	
400-F20R	400 m/ 1200 m	20x2	

6 bar - 60°C

- 1
- 2
- 3
- 4
- 5
- 6
- 7
- 8
- 9
- 10
- 11



D. PE-Xc

Type: 5L PE-Xc



Henco 5L PE-Xc pipe PE-Xc/EVOH/PE-Xc (Coil)
Henco 5L PE-Xc buis PE-Xc/EVOH/PE-Xc (Rol)
Henco 5L PE-Xc tube PE-Xc/EVOH/PE-Xc (Rouleau)
Henco 5L PE-Xc Rohr PE-Xc/EVOH/PE-Xc (Ring)

Article number	m/ Pallet	Type	Subgroup
200-PXC1620	200 m / 1600 m	16x2	
600-PXC1620	600 m / 2400 m	16x2	
200-PXC1720	200 m / 2000 m	17x2	
600-PXC1720	600 m / 2400 m	17x2	
240-PXC1820	240 m / 2400 m	18x2	
200-PXC2020	200 m / 1000 m	20x2	
600-PXC2020	600 m / 1200 m	20x2	



Type: 5L PE-RT



Henco 5L PE-RT pipe PE-RT/EVOH/PE-RT (Coil)
 Henco 5L PE-RT buis PE-RT/EVOH/PE-RT (Rol)
 Henco 5L PE-RT tube PE-RT/EVOH/PE-RT (Rouleau)
 Henco 5L PE-RT Rohr PE-RT/EVOH/PE-RT (Ring)

Article number	m/ Pallet	Type	Subgroup
120-FRT1620	120 m/ 1440 m	16x2	
200-FRT1620	200 m/ 1600 m	16x2	
600-FRT1620	600 m/ 2400 m	16x2	
600-FRT1720	600 m/ 2400 m	17x2	
600-FRT1820	600 m/ 1200 m	18x2	
600-FRT2020	600 m/ 1800 m	20x2	

- 1
- 2
- 3
- 4
- 5
- 6
- 7
- 8
- 9
- 10
- 11



F. PROTECTIOn HOSE

- 1
- 2
- 3
- 4
- 5
- 6
- 7
- 8
- 9
- 10
- 11

Type: PROTECTION HOSE



Colour coded conduit (Coil)
 Mantel (Rol)
 Gaine (Rouleau)
 Mantel (Ring)

Article number	m/ Pallet	Type	Subgroup
100-MR	100 m/ 2400 m	Ø14/Ø16/Ø18 red (ID19-CD23)	1.16FRP
100-MB	100 m/ 2400 m	Ø14/Ø16/Ø18 blue (ID19-CD23)	1.16FRP
50-MR20	50 m/ 1800 m	Ø20 red (ID23-CD28)	1.20FRP
50-MB20	50 m/ 1800 m	Ø20 blue (ID23-CD28)	1.20FRP
50-MR26	50 m/ 1200 m	Ø26 red (ID29,5-CD34)	1.26FRP
50-MB26	50 m/ 1200 m	Ø26 blue (ID29,5-CD34)	1.26FRP
25-MR32	25 m/ 1000 m	Ø32 red (ID36,5-CD41,5)	1.32FRP
25-MB32	25 m/ 1000 m	Ø32 blue (ID36,5-CD41,5)	1.32FRP
100-MBLACK	100 m/ 2400 m	Ø14/Ø16/Ø18 black (ID19-CD23)	1.16FRP
50-MBLACK20	50 m/ 1800 m	Ø20 black (ID23-CD28)	1.20FRP
50-MBLACK26	50 m/ 1200 m	Ø26 black (ID29,5-CD34)	1.26FRP

Type: PROTECTION HOSE GAS



Colour coded conduit (Coil)
 Mantel (Rol)
 Gaine (Rouleau)
 Mantel (Ring)

Article number	m/ Pallet	Type	Subgroup
50-MG16	50 m/ 2400 m	Ø16 yellow	1.16FR GA
100-MG16	100 m/ 2400 m	Ø16 yellow	1.16FR GA
50-MG20	50 m/ 1800 m	Ø20 yellow	1.20FR GA
50-MG26	50 m/ 1200 m	Ø26 yellow	1.26FR GA
25-MG32	25 m/ 1000 m	Ø32 yellow	1.32FR GA



Gas: only allowed in countries where has been a HENCO GAS testing + certificate is available! (see www.henco.be)
 Gas: enkel toegelaten in landen waar er een HENCO GAS keur is + een certificaat voorhanden is! (zie www.henco.be)
 Gaz: seulement permis dans des pays où le controle a eu lieu + certificat est disponible! (Consultez www.henco.be)
 Gas: nur zugelassen in Länder wo HENCO GAS Prüfung geschehen ist + Zertifikat vorhanden ist! (Siehe www.henco.be)

- 1
- 2
- 3
- 4
- 5
- 6
- 7
- 8
- 9
- 10
- 11

Type: COIL



Henco multilayer pipe (Coil)
 Henco Meerlagenbuis (Rol)
 Henco tube multicouche (Rouleau)
 Henco Mehrschichtverbundrohr (Ring)

Article number	m/ Pallet	Type	Subgroup
50-160212-GAS	50 m/ 1500 m	16x2	1.16GA
50-200216-GAS	50 m/ 1000 m	20x2	1.20GA
50-260320-GAS	50 m/ 800 m	26x3	1.26GA
50-320326-GAS	50 m/ 650 m	32x3	1.32GA

Type: STRAIGHT LENGTH



Henco multilayer pipe (Straight length)
 Henco Meerlagenbuis (Stang)
 Henco tube multicouche (Barre)
 Henco Mehrschichtverbundrohr (Stange)

Article number	Cylinder / Pallet	Type	Subgroup
05-160212-GAS	125 m/ 6000 m	16x2	2.16GAB
05-200216-GAS	90 m/ 4300 m	20x2	2.20GAB
05-260320-GAS	50 m/ 2400 m	26x3	2.26GAB
05-320326-GAS	35 m/ 1680 m	32x3	2.32GAB
05-403533-GAS	45 m/ 1080 m	40x3,5	2.40GAB

Type: GAS PIPE IN PIPE



With colour coded conduit (Coil)
 Met mantel (Rol)
 Avec gaine (Rouleau)
 Mit Mantel (Ring)

Article number	m/ Pallet	Typ	Subgroup
50-016GASMG	50 m/ 500 m	16x2	1.16GATP
50-020GASMG	50 m/ 800 m	20x2	1.20GATP
50-026GASMG	50 m/ 500 m	26x3	1.26GATP
25-032GASMG	25 m/ 300 m	32x3	1.32GATP

Gastec: Standard pipe gas in combination with Henco press fittings PVDF for gas, see page 38

DVGW and Kiwa Uni: Standard pipe gas in combination with Henco brass press fittings for gas, see page 79





	Page
A. STANDARD	21
B. GAS	38
C. SUPER SIZE	44



Type: 1PK



Elbow 90°
Knie 90°
Coude 90°
Winkel 90°

Article number	Bag / Box	Type	Subgroup
1PK-1414	10 pc. / 150 pc.	14x14	
1PK-1616	10 pc. / 120 pc.	16x16	
1PK-1818	10 pc. / 100 pc.	18x18	
1PK-2020	10 pc. / 80 pc.	20x20	
1PK-2626	5 pc. / 50 pc.	26x26	
1PK-3232	5 pc. / 30 pc.	32x32	
1PK-4040	5 pc. / 20 pc.	40x40	
1PK-5050	1 pc. / 8 pc.	50x50	
1PK-6363	1 pc. / 6 pc.	63x63	
1PK-7575	See page 44	75x75	
1PK-9090	See page 44	90x90	
1PK-9075	See page 44	90x75	

- 1
- 2
- 3
- 4
- 5
- 6
- 7
- 8
- 9
- 10
- 11

Type: 1PK-JG



Elbow 90° 16x10JG (ceiling cooling)
Knie 90° 16x10JG (koelplafond)
Coude 90° 16x10JG (plafond climatisé)
Winkel 90° 16x10JG (Klimaatplafond)

Article number	Bag / Box	Type	Subgroup
• 1PK-16JG10	10 pc. / 120 pc.	16x10JG	

Type: 2PK



Backplate elbow female
Sanitair muurplaat binnendraad
Culasse pour sanitaire
Sanitär Wandscheibe IG

Article number	Bag / Box	Type	Subgroup
2PK-1404BP*	10 pc. / 50 pc.	14x1/2" (56 mm)	
2PK-1603	10 pc. / 50 pc.	16x3/8" (56 mm)	
2PK-1604BP*	10 pc. / 50 pc.	16x1/2" (56 mm)	
2PK-1804BP*	10 pc. / 50 pc.	18x1/2" (56 mm)	
2PK-2004BP*	10 pc. / 50 pc.	20x1/2" (56 mm)	
2PK-2005	5 pc. / 30 pc.	20x3/4" (56 mm)	
2PK-2605	5 pc. / 30 pc.	26x3/4" (56 mm)	

* With black plug BP04 1/2"

Type: H



Bracket for backplate
Tappuntbeugel voor muurplaat
Support pour culasse sanitaire
Halteplatte für Sanitär Wandscheibe

Article number	Bag / Box	Type	Subgroup
H716042005	10 pc. / 250 pc.	For: 2PK, 2PK-K, 3PK	

Type: 2PK-K



Backplate elbow female, short model
Sanitair muurplaat binnendraad, laag
Culasse pour sanitaire, modèle court
Sanitär Wandscheibe IG, kurzes Modell

Article number	Bag / Box	Type	Subgroup
2PK-1604KBP*	10 pc. / 50 pc.	16x1/2" (40 mm)	

* With black plug BP04 1/2"

Type: 3PK



Double backplate elbow female, short model
Sanitair muurplaat binnendraad dubbel, laag
Culasse double pour sanitaire, modèle court
Sanitär Wandscheibe doppelt IG, kurzes Modell

Article number	Bag / Box	Type	Subgroup
3PK-160416BP*	10 pc. / 30 pc.	16x1/2"x16 (40 mm)	
3PK-200420BP*	10 pc. / 30 pc.	20x1/2"x20 (40 mm)	

* With black plug BP04 1/2"

Type: BP04



Black plug for 1/2" female nipple
Zwarte stop voor 1/2"
Bouchon noir pour 1/2" nipple femelle
Schwarzen Stopf für 1/2" Nippel

Article number	Bag / Box	Type	Subgroup
BP04	50 pc. / 500 pc.	1/2"	



Type: 5PK



Bent 90° male adapter
Knie 90° buitendraad
Coude 90° mâle
Winkel 90° AG

Article number	Bag / Box	Type	Subgroup
5PK-1404	10 pc. / 60 pc.	14x1/2"	
5PK-1604	10 pc. / 60 pc.	16x1/2"	
5PK-1804	10 pc. / 60 pc.	18x1/2"	
5PK-2004	10 pc. / 60 pc.	20x1/2"	
5PK-2005	10 pc. / 50 pc.	20x3/4"	
5PK-2605	10 pc. / 40 pc.	26x3/4"	
5PK-3206	5 pc. / 20 pc.	32x1"	
5PK-4007	5 pc. / 15 pc.	40x1, 1/4"	
5PK-5007	1 pc. / 10 pc.	50x1, 1/4"	
5PK-5008	1 pc. / 8 pc.	50x1, 1/2"	
5PK-6310	1 pc. / 4 pc.	63x2"	
5PK-7510	See page 44	75x2"	
5PK-7512	See page 44	75x2, 1/2"	

- 1
- 2
- 3
- 4
- 5
- 6
- 7
- 8
- 9
- 10
- 11

Type: 6PK



Bent 90° female adapter
Knie 90° binnendraad
Coude 90° femelle
Winkel 90° IG

Article number	Bag / Box	Type	Subgroup
6PK-1404BP*	10 pc. / 60 pc.	14x1/2"	
6PK-1603	10 pc. / 60 pc.	16x3/8"	
6PK-1604BP*	10 pc. / 60 pc.	16x1/2"	
6PK-1804BP*	10 pc. / 60 pc.	18x1/2"	
6PK-2004BP*	10 pc. / 60 pc.	20x1/2"	
6PK-2005	10 pc. / 50 pc.	20x3/4"	
6PK-2605	10 pc. / 50 pc.	26x3/4"	
6PK-3206	5 pc. / 20 pc.	32x1"	
6PK-4007	5 pc. / 15 pc.	40x1, 1/4"	
6PK-5007	1 pc. / 8 pc.	50x1, 1/4"	
6PK-5008	1 pc. / 8 pc.	50x1, 1/2"	
6PK-6310	1 pc. / 4 pc.	63x2"	
6PK-7506	See page 44	75x1"	
6PK-7510	See page 44	75x2"	
6PK-7512	See page 44	75x2, 1/2"	
6PK-9014	See page 44	90x3"	

* With black plug BP04 1/2"

Type: 9PK



T-piece
T-stuk
Pièce en T
T-Stück

Article number	Bag / Box	Type	Subgroup
9FK-141414	10 pc. / 100 pc.	14x14x14	
9FK-161616	10 pc. / 60 pc.	16x16x16	
9FK-181818	10 pc. / 60 pc.	18x18x18	
9FK-202020	10 pc. / 50 pc.	20x20x20	
9FK-262626	5 pc. / 30 pc.	26x26x26	
9FK-323232	5 pc. / 15 pc.	32x32x32	
9FK-404040	5 pc. / 10 pc.	40x40x40	
9FK-505050	1 pc. / 6 pc.	50x50x50	
9FK-636363	1 pc. / 3 pc.	63x63x63	
9FK-757575	See page 44	75x75x75	
9FK-909090	See page 44	90x90x90	



Type: 10PK



T-reduced centre
T-verlopend
Pièce en T-réduit
T-reduziert

Article number	Bag / Box	Type	Subgroup
10PK-161416	10 pc. / 50 pc.	16x14x16	
10PK-181418	10 pc. / 50 pc.	18x14x18	
10PK-181618	10 pc. / 50 pc.	18x16x18	
10PK-201420	10 pc. / 50 pc.	20x14x20	
10PK-201620	10 pc. / 50 pc.	20x16x20	
10PK-201820	10 pc. / 50 pc.	20x18x20	
10PK-261626	5 pc. / 30 pc.	26x16x26	
10PK-261826	5 pc. / 30 pc.	26x18x26	
10PK-262026	5 pc. / 30 pc.	26x20x26	
10PK-321632	5 pc. / 25 pc.	32x16x32	
10PK-321832	5 pc. / 25 pc.	32x18x32	
10PK-322032	5 pc. / 25 pc.	32x20x32	
10PK-322632	5 pc. / 20 pc.	32x26x32	
10PK-401640	5 pc. / 15 pc.	40x16x40	
10PK-402040	5 pc. / 15 pc.	40x20x40	
10PK-402640	5 pc. / 15 pc.	40x26x40	
10PK-403240	5 pc. / 10 pc.	40x32x40	
10PK-502050	1 pc. / 6 pc.	50x20x50	
10PK-502650	1 pc. / 8 pc.	50x26x50	
10PK-503250	1 pc. / 8 pc.	50x32x50	
10PK-504050	1 pc. / 6 pc.	50x40x50	
10PK-632663	1 pc. / 4 pc.	63x26x63	
10PK-633263	1 pc. / 3 pc.	63x32x63	
10PK-634063	1 pc. / 3 pc.	63x40x63	
10PK-635063	1 pc. / 3 pc.	63x50x63	
10PK-754075	See page 44	75x40x75	
10PK-755075	See page 44	75x50x75	
10PK-756375	See page 44	75x63x75	
10PK-904090	See page 44	90x40x90	
10PK-905090	See page 44	90x50x90	
10PK-906390	See page 44	90x63x90	
10PK-907590	See page 44	90x75x90	

- 1
- 2
- 3
- 4
- 5
- 6
- 7
- 8
- 9
- 10
- 11

Type: 10PK-JG



T-reduced centre 16x10JGx16 (ceiling cooling)
T-verlopend 16x10JGx16 (koelplafond)
Pièce en T-réduit 16x10JGx16 (plafond climatisé)
T-reduziert 16x10JGx16 (Klimaatplafond)

Article number	Bag / Box	Type	Subgroup
• 10PK-16JG1016	10 pc. / 50 pc.	16x10JGx16	
• 10PK-20JG1020	10 pc. / 50 pc.	20x10JGx20	

Type: 11PK



T-branch and line reduced

T-2X verlopend

Pièce en T 2X réduit

T-2X reduziert

Article number	Bag / Box	Type	Subgroup
11PK-161414	10 pc. / 50 pc.	16x14x14	
11PK-181616	10 pc. / 50 pc.	18x16x16	
11PK-201616	10 pc. / 50 pc.	20x16x16	
11PK-201818	10 pc. / 50 pc.	20x18x18	
11PK-202016	10 pc. / 50 pc.	20x20x16	
11PK-261616	10 pc. / 50 pc.	26x16x16	
11PK-261620	5 pc. / 30 pc.	26x16x20	
11PK-262016	5 pc. / 30 pc.	26x20x16	
11PK-262020	5 pc. / 30 pc.	26x20x20	
11PK-262616	5 pc. / 30 pc.	26x26x16	
11PK-262620	5 pc. / 30 pc.	26x26x20	
11PK-322026	5 pc. / 20 pc.	32x20x26	
11PK-322626	5 pc. / 20 pc.	32x26x26	
11PK-402032	5 pc. / 15 pc.	40x20x32	
11PK-402632	5 pc. / 15 pc.	40x26x32	
11PK-403232	5 pc. / 10 pc.	40x32x32	
11PK-404026	5 pc. / 10 pc.	40x40x26	
11PK-404032	5 pc. / 10 pc.	40x40x32	
11PK-502040	1 pc. / 10 pc.	50x20x40	
11PK-502640	1 pc. / 10 pc.	50x26x40	
11PK-503240	1 pc. / 10 pc.	50x32x40	
11PK-504040	1 pc. / 8 pc.	50x40x40	
11PK-754040	See page 44	75x40x40	
11PK-754050	See page 44	75x40x50	
11PK-754063	See page 44	75x40x63	
11PK-755050	See page 44	75x50x50	
11PK-755063	See page 44	75x50x63	
11PK-756363	See page 44	75x63x63	
11PK-904040	See page 44	90x40x40	
11PK-904050	See page 44	90x40x50	
11PK-904063	See page 44	90x40x63	
11PK-904075	See page 44	90x40x75	
11PK-905050	See page 44	90x50x50	
11PK-905063	See page 44	90x50x63	
11PK-905075	See page 44	90x50x75	
11PK-906363	See page 44	90x63x63	
11PK-906375	See page 44	90x63x75	
11PK-907575	See page 44	90x75x75	



Type: 12PK



T-enlarged branch
T-vergroot
Pièce en T agrandi
T-erweitert

Article number	Bag / Box	Type	Subgroup
12PK-161816	10 pc. / 50 pc.	16x18x16	
12PK-162016	10 pc. / 50 pc.	16x20x16	
12PK-202620	5 pc. / 30 pc.	20x26x20	
12PK-263226	5 pc. / 20 pc.	26x32x26	
12PK-324032	5 pc. / 15 pc.	32x40x32	
12PK-405040	1 pc. / 8 pc.	40x50x40	
12PK-407540	See page 44	40x75x40	
12PK-507550	See page 44	50x75x50	
12PK-637563	See page 44	63x75x63	
12PK-409040	See page 44	40x90x40	
12PK-509050	See page 44	50x90x50	
12PK-639063	See page 44	63x90x63	
12PK-759075	See page 44	75x90x75	

- 1
- 2
- 3
- 4
- 5
- 6
- 7
- 8
- 9
- 10
- 11

Type: 13PK



T-female centre
T-binnendraad
Pièce en T femelle
T-IG

Article number	Bag / Box	Type	Subgroup
13PK-160416BP*	10 pc. / 50 pc.	16x1/2"x16	
13PK-180418BP*	10 pc. / 50 pc.	18x1/2"x18	
13PK-200420BP*	10 pc. / 50 pc.	20x1/2"x20	
13PK-200520	10 pc. / 30 pc.	20x3/4"x20	
13PK-260420BP*	5 pc. / 30 pc.	26x1/2"x20	
13PK-260426BP*	5 pc. / 30 pc.	26x1/2"x26	
13PK-260526	5 pc. / 30 pc.	26x3/4"x26	
13PK-320532	5 pc. / 15 pc.	32x3/4"x32	
13PK-320632	5 pc. / 10 pc.	32x1"x32	
13PK-320732	5 pc. / 10 pc.	32x1,1/4"x32	
13PK-400640	5 pc. / 10 pc.	40x1"x40	
13PK-400740	5 pc. / 10 pc.	40x1,1/4"x40	
13PK-500850	1 pc. / 4 pc.	50x1,1/2"x50	
13PK-631063	1 pc. / 2 pc.	63x2"x63	
13PK-750675	See page 45	75x1"x75	
13PK-751075	See page 45	75x2"x75	
13PK-751275	See page 45	75x2,1/2"x75	
13PK-901490	See page 45	90x3"x90	

* With black plug BP04 1/2"

A. STANDARD

Type: 14PK



T-male centre
T-buitendraad
Pièce en T mâle
T-AG

Article number	Bag / Box	Type	Subgroup
14PK-160416	10 pc. / 50 pc.	16x1/2"x16	
14PK-180418	10 pc. / 50 pc.	18x1/2"x18	
14PK-200420	10 pc. / 40 pc.	20x1/2"x20	
14PK-200520	10 pc. / 30 pc.	20x3/4"x20	
14PK-260426	5 pc. / 30 pc.	26x1/2"x26	
14PK-260526	5 pc. / 25 pc.	26x3/4"x26	
14PK-260626	5 pc. / 20 pc.	26x1"x26	
14PK-320532	5 pc. / 15 pc.	32x3/4"x32	
14PK-400640	5 pc. / 10 pc.	40x1"x40	
14PK-400740	5 pc. / 10 pc.	40x1,1/4"x40	
14PK-500850	1 pc. / 5 pc.	50x1,1/2"x50	
14PK-631063	1 pc. / 2 pc.	63x2"x63	
14PK-751075	See page 45	75x2"x75	
14PK-751275	See page 45	75x2,1/2"x75	

Type: 15PK



Straight coupling
Doorverbinder recht / perssok
Manchon
Kupplung

Article number	Bag / Box	Type	Subgroup
15PK-1414	10 pc. / 150 pc.	14x14	
15PK-1616	10 pc. / 150 pc.	16x16	
15PK-1818	10 pc. / 100 pc.	18x18	
15PK-2020	10 pc. / 80 pc.	20x20	
15PK-2626	5 pc. / 50 pc.	26x26	
15PK-3232	5 pc. / 30 pc.	32x32	
15PK-4040	5 pc. / 25 pc.	40x40	
15PK-5050	1 pc. / 12 pc.	50x50	
15PK-6363	1 pc. / 9 pc.	63x63	
15PK-7575	See page 45	75x75	
15PK-9090	See page 45	90x90	



Type: 16PK



Reducing coupling
Verloopstuk
Réduction
Kupplung-reduziert

Article number	Bag / Box	Type	Subgroup
16PK-1614	10 pc. / 100 pc.	16x14	
16PK-1814	10 pc. / 100 pc.	18x14	
16PK-1816	10 pc. / 100 pc.	18x16	
16PK-2014	10 pc. / 100 pc.	20x14	
16PK-2016	10 pc. / 100 pc.	20x16	
16PK-2018	10 pc. / 100 pc.	20x18	
16PK-2616	5 pc. / 60 pc.	26x16	
16PK-2618	5 pc. / 50 pc.	26x18	
16PK-2620	5 pc. / 50 pc.	26x20	
16PK-3216	5 pc. / 50 pc.	32x16	
16PK-3220	5 pc. / 40 pc.	32x20	
16PK-3226	5 pc. / 40 pc.	32x26	
16PK-4026	5 pc. / 30 pc.	40x26	
16PK-4032	5 pc. / 25 pc.	40x32	
16PK-5032	1 pc. / 15 pc.	50x32	
16PK-5040	1 pc. / 15 pc.	50x40	
16PK-6340	1 pc. / 8 pc.	63x40	
16PK-6350	1 pc. / 8 pc.	63x50	
16PK-7540	See page 45	75x40	
16PK-7550	See page 45	75x50	
16PK-7563	See page 45	75x63	
16PK-9040	See page 45	90x40	
16PK-9050	See page 45	90x50	
16PK-9063	See page 45	90x63	
16PK-9075	See page 45	90x75	

- 1
- 2
- 3
- 4
- 5
- 6
- 7
- 8
- 9
- 10
- 11

Type: 17PK



Straight male adapter
 Recht aansluitstuk buitendraad / Puntstuk
 Raccord droit mâle
 Übergangsstück AG

Article number	Bag / Box	Type	Subgroup
17PK-1404	10 pc. / 80 pc.	14x1/2"	
17PK-1604	10 pc. / 80 pc.	16x1/2"	
17PK-1804	10 pc. / 80 pc.	18x1/2"	
17PK-1805	10 pc. / 50 pc.	18x3/4"	
17PK-2004	10 pc. / 80 pc.	20x1/2"	
17PK-2005	10 pc. / 50 pc.	20x3/4"	
17PK-2605	10 pc. / 50 pc.	26x3/4"	
17PK-2606	10 pc. / 40 pc.	26x1"	
17PK-3206	10 pc. / 40 pc.	32x1"	
17PK-3207	5 pc. / 25 pc.	32x1, 1/4"	
17PK-4006	5 pc. / 25 pc.	40x1"	
17PK-4007	5 pc. / 25 pc.	40x1, 1/4"	
17PK-5008	1 pc. / 10 pc.	50x1, 1/2"	
17PK-6310	1 pc. / 6 pc.	63x2"	
17PK-7510	See page 46	75x2"	
17PK-7512	See page 46	75x2, 1/2"	

Type: 18PK



Straight female adapter
 Recht aansluitstuk binnendraad / Schroefbus
 Raccord droit femelle
 Übergangsstück IG

Article number	Bag / Box	Type	Subgroup
18PK-1404	10 pc. / 80 pc.	14x1/2"	
18PK-1604	10 pc. / 80 pc.	16x1/2"	
18PK-1804	10 pc. / 80 pc.	18x1/2"	
18PK-1805	10 pc. / 50 pc.	18x3/4"	
18PK-2004	10 pc. / 80 pc.	20x1/2"	
18PK-2005	10 pc. / 50 pc.	20x3/4"	
18PK-2605	10 pc. / 50 pc.	26x3/4"	
18PK-2606	10 pc. / 40 pc.	26x1"	
18PK-3206	10 pc. / 40 pc.	32x1"	
18PK-3207	5 pc. / 25 pc.	32x1, 1/4"	
18PK-4006	5 pc. / 25 pc.	40x1"	
18PK-4007	5 pc. / 25 pc.	40x1, 1/4"	
18PK-5008	1 pc. / 10 pc.	50x1, 1/2"	
18PK-6310	1 pc. / 6 pc.	63x2"	
18PK-7506	See page 46	75x1"	
18PK-7510	See page 46	75x2"	
18PK-7512	See page 46	75x2, 1/2"	
18PK-9014	See page 46	90x3"	



Type: 19PK



Press fitting with swivel to eurocone
 Perskoppeling met wartel en euroconus aansluiting
 Raccord à sertir avec écrou à visser eurocone
 Pressfitting mit Drehbar und Eurokonus

Article number	Bag / Box	Type	Subgroup
19FK-1605	10 pc. / 80 pc.	16x3/4"	
19FK-2005	10 pc. / 80 pc.	20x3/4"	

Type: 26PK



Press fitting with swivel and flat sealing
 Perskoppeling met wartel en vlakke dichting
 Raccord avec écrou et joint plat
 Pressfitting mit Drehbar und Flach Versiegelung

Article number	Bag / Box	Type	Subgroup
26FK-1605	10 pc. / 80 pc.	16x3/4"	
26FK-2005	10 pc. / 80 pc.	20x3/4"	
• 26FK-4008	5 pc. / 15 pc.	40x1, 1/2"	
• 26FK-5010	1 pc. / 10 pc.	50x2"	
• 26FK-6312	1 pc. / 6 pc.	63x2, 1/2"	

Type: 27PK



45° bend
 Bocht 45°
 Coude 45°
 Winkel 45°

Article number	Bag / Box	Type	Subgroup
27FK-4040	5 pc. / 25 pc.	40x40	
27FK-5050	1 pc. / 10 pc.	50x50	
27FK-6363	1 pc. / 5 pc.	63x63	
27FK-7575	See page 46	75x75	
27FK-9090	See page 46	90x90	

Type: 28PK-04



Clip for 28PK-2PK1604, 28PK-6PK1604 and 28PK-13PK160416
 Beugel voor 28PK-2PK1604, 28PK-6PK1604 en 28PK-13PK160416
 Attache pour 28PK-2PK1604, 28PK-6PK1604 et 28PK-13PK160416
 Bügel für 28PK-2PK1604, 28PK-6PK1604 und 28PK-13PK160416

Article number	Box	Type	Subgroup
28FK-04	50 pc.	1/2"	

- 1
- 2
- 3
- 4
- 5
- 6
- 7
- 8
- 9
- 10
- 11

Type: 28PK-2PK1604



Double backplate 153mm centres for art. 2PK-1604
 Dubbele muurplaat 153mm asafstand voor art. 2PK-1604
 Culasse double, entraxe 153mm pour art. 2PK-1604
 Wandwinkel doppelt 153mm Abstand für Art.2PK-1604

Article number	Bag / Box	Type	Subgroup
28PK-2PK1604BP*	2 pc. / 10 pc.	2x(16x1/2")	

* With black plug BP04 1/2"

Type: 28PK-6PK1604



Double backplate 153mm centres for art. 6PK-1604
 Dubbele muurplaat 153mm asafstand voor art. 6PK-1604
 Culasse double, entraxe 153mm pour art. 6PK-1604
 Wandwinkel doppelt 153mm Abstand für Art.6PK-1604

Article number	Bag / Box	Type	Subgroup
28PK-6PK1604BP*	2 pc. / 18 pc.	2x(16x1/2")	

* With black plug BP04 1/2"

Type: 28PK-13PK1604



Double backplate 153mm centres for art. 13PK-160416
 Dubbele muurplaat 153mm asafstand voor art. 13PK-160416
 Culasse double, entraxe 153mm pour art. 13PK-160416
 Wandwinkel doppelt 153mm Abstand für Art.13PK-160416

Article number	Bag / Box	Type	Subgroup
28PK-13PK1604BP*	2 pc. / 8 pc.	2x(16x1/2")	

* With black plug BP04 1/2"



Type: 53PK



Easy mounting fitting
 Eenvoudige montage fitting
 Raccord montage facile
 Einfache Montage Fitting

Article number	Bag / Box	Type	Subgroup
53PK40	1 pc. / 20 pc.	40x40	
53PK50	1 pc. / 9 pc.	50x50	
53PK63	1 pc. / 6 pc.	63x63	

for Ø16, 20, 26 and 32: chapter 4, article 52P

- 1
- 2
- 3
- 4
- 5
- 6
- 7
- 8
- 9
- 10
- 11

Type: 1PKW



Elbow 90°
Knie 90°
Coude 90°
Winkel 90°

Article number	Bag / Box	Type	Subgroup
• 1PKW-1616	10 pc. / 120 pc.	16x16	
• 1PKW-2020	10 pc. / 80 pc.	20x20	
• 1PKW-2626	5 pc. / 50 pc.	26x26	
• 1PKW-3232	5 pc. / 30 pc.	32x32	

Type: 2PKW

Backplate elbow female
Sanitair muurplaat binnendraad
Culasse pour sanitaire
Sanitär Wandscheibe IG

Article number	Bag / Box	Type	Subgroup
• 2PKW-1604BP*	10 pc. / 50 pc.	16x1/2" (56 mm)	
• 2PKW-2004BP*	10 pc. / 50 pc.	20x1/2" (56 mm)	
• 2PKW-2005	5 pc. / 30 pc.	20x3/4" (56 mm)	
• 2PKW-2605	5 pc. / 30 pc.	26x3/4" (56 mm)	

* With black plug BP04 1/2"

Type: 5PKW



Bent 90° male adapter
Knie 90° buitendraad
Coude 90° mâle
Winkel 90° AG

Article number	Bag / Box	Type	Subgroup
• 5PKW-1604	10 pc. / 60 pc.	16x1/2"	
• 5PKW-2004	10 pc. / 60 pc.	20x1/2"	
• 5PKW-2005	10 pc. / 50 pc.	20x3/4"	
• 5PKW-2605	10 pc. / 40 pc.	26x3/4"	
• 5PKW-3206	5 pc. / 20 pc.	32x1"	



Type: 6PKW



Bent 90° female adapter
Knie 90° binnendraad
Coude 90° femelle
Winkel 90° IG

Article number	Bag / Box	Type	Subgroup
• 6PKW-1603	10 pc. / 60 pc.	16x3/8"	
• 6PKW-1604BP*	10 pc. / 60 pc.	16x1/2"	
• 6PKW-2004BP*	10 pc. / 60 pc.	20x1/2"	
• 6PKW-2005	10 pc. / 50 pc.	20x3/4"	
• 6PKW-2605	10 pc. / 50 pc.	26x3/4"	
• 6PKW-3206	5 pc. / 20 pc.	32x1"	

* With black plug BP04 1/2"

Type: 9PKW



T-piece
T-stuk
Pièce en T
T-Stück

Article number	Bag / Box	Type	Subgroup
• 9PKW-161616	10 pc. / 60 pc.	16x16x16	
• 9PKW-202020	10 pc. / 50 pc.	20x20x20	
• 9PKW-262626	5 pc. / 30 pc.	26x26x26	
• 9PKW-323232	5 pc. / 15 pc.	32x32x32	

Type: 10PKW



T-reduced centre
T-verlopend
T-réduit
T-reduziert

Article number	Bag / Box	Type	Subgroup
• 10PKW-201620	10 pc. / 50 pc.	20x16x20	
• 10PKW-261626	5 pc. / 30 pc.	26x16x26	
• 10PKW-262026	5 pc. / 30 pc.	26x20x26	
• 10PKW-321632	5 pc. / 25 pc.	32x16x32	
• 10PKW-322032	5 pc. / 25 pc.	32x20x32	
• 10PKW-322632	5 pc. / 20 pc.	32x26x32	

- 1
- 2
- 3
- 4
- 5
- 6
- 7
- 8
- 9
- 10
- 11

Type: 11PKW



T-branch and line reduced
T-2X verlopend
T-2X réduit
T-2X reduziert

Article number	Bag / Box	Type	Subgroup
• 11PKW-201616	10 pc. / 50 pc.	20x16x16	
• 11PKW-202016	10 pc. / 50 pc.	20x20x16	
• 11PKW-261620	5 pc. / 30 pc.	26x16x20	
• 11PKW-262016	5 pc. / 30 pc.	26x20x16	
• 11PKW-262020	5 pc. / 30 pc.	26x20x20	
• 11PKW-262616	5 pc. / 30 pc.	26x26x16	
• 11PKW-262620	5 pc. / 30 pc.	26x26x20	
• 11PKW-322026	5 pc. / 20 pc.	32x20x26	
• 11PKW-322626	5 pc. / 20 pc.	32x26x26	

Type: 12PKW



T-enlarged branch
T-vergroot
T-agrandi
T-erweitert

Article number	Bag / Box	Type	Subgroup
• 12PKW-162016	10 pc. / 50 pc.	16x20x16	
• 12PKW-202620	5 pc. / 30 pc.	20x26x20	

Type: 13PKW



T-female centre
T-binnendraad
T-femelle
T-IG

Article number	Bag / Box	Type	Subgroup
• 13PKW-160416BP*	10 pc. / 50 pc.	16x1/2"x16	
• 13PKW-200420BP*	10 pc. / 50 pc.	20x1/2"x20	
• 13PKW-200520	10 pc. / 30 pc.	20x3/4"x20	
• 13PKW-260426BP*	5 pc. / 30 pc.	26x1/2"x26	
• 13PKW-260526	5 pc. / 30 pc.	26x3/4"x26	
• 13PKW-320532	5 pc. / 15 pc.	32x3/4"x32	
• 13PKW-320632	5 pc. / 10 pc.	32x1"x32	

* With black plug BP04 1/2"

Type: 14PKW



T-male centre
T-buitendraad
T-mâle
T-AG

Article number	Bag / Box	Type	Subgroup
• 14PKW-160416	10 pc. / 50 pc.	16x1/2"x16	



Type: 15PKW



Straight coupling
 Doorverbinder recht
 Manchon
 Kupplung

Article number	Bag / Box	Type	Subgroup
• 15PKW-1616	10 pc. / 150 pc.	16x16	
• 15PKW-2020	10 pc. / 80 pc.	20x20	
• 15PKW-2626	5 pc. / 50 pc.	26x26	
• 15PKW-3232	5 pc. / 30 pc.	32x32	

Type: 16PKW



Reducing coupling
 Verloopstuk
 Réduction
 Kupplung-reduziert

Article number	Bag / Box	Type	Subgroup
• 16PKW-2016	10 pc. / 100 pc.	20x16	
• 16PKW-2620	5 pc. / 50 pc.	26x20	
• 16PKW-3220	5 pc. / 40 pc.	32x20	
• 16PKW-3226	5 pc. / 40 pc.	32x26	

Type: 17PKW



Straight male adapter
 Recht aansluitstuk buitendraad / Puntstuk
 Raccord droit mâle
 Übergangsstück AG

Article number	Bag / Box	Type	Subgroup
• 17PKW-1604	10 pc. / 80 pc.	16x1/2"	
• 17PKW-2004	10 pc. / 80 pc.	20x1/2"	
• 17PKW-2005	10 pc. / 50 pc.	20x3/4"	
• 17PKW-2605	10 pc. / 50 pc.	26x3/4"	
• 17PKW-2606	10 pc. / 40 pc.	26x1"	
• 17PKW-3206	10 pc. / 40 pc.	32x1"	

Type: 18PKW



Straight female adapter
 Recht aansluitstuk binnendraad / Schroefbus
 Raccord droit femelle
 Übergangsstück IG

Article number	Bag / Box	Type	Subgroup
• 18PKW-1604	10 pc. / 80 pc.	16x1/2"	
• 18PKW-2004	10 pc. / 80 pc.	20x1/2"	
• 18PKW-2005	10 pc. / 50 pc.	20x3/4"	
• 18PKW-2605	10 pc. / 50 pc.	26x3/4"	
• 18PKW-2606	10 pc. / 40 pc.	26x1"	
• 18PKW-3206	10 pc. / 40 pc.	32x1"	

- 1
- 2
- 3
- 4
- 5
- 6
- 7
- 8
- 9
- 10
- 11

Gas: only allowed in countries where has been a HENCO GAS testing + certificate is available! (See www.henco.be)
 Gas: enkel toegelaten in landen waar er een HENCO GAS keur is + een certificaat voorhanden is! (zie www.henco.be)
 Gaz: seulement permis dans des pays où le contrôle a eu lieu + certificat est disponible! (Consultez www.henco.be)
 Gas: nur zugelassen in Länder wo HENCO GAS Prüfung geschehen ist + Zertifikat vorhanden ist! (Siehe www.henco.be)

Henco press fittings PVDF for gas in combination with standard pipe gas, see page 19



Type: 1PKG



Elbow 90°
 Knie 90°
 Coude 90°
 Winkel 90°

Article number	Bag / Box	Type	Subgroup
1PKG-1616	10 pc. / 120 pc.	16x16	
1PKG-2020	10 pc. / 80 pc.	20x20	
1PKG-2626	5 pc. / 50 pc.	26x26	
1PKG-3232	5 pc. / 30 pc.	32x32	
1PKG-4040	5 pc. / 20 pc.	40x40	

Type: 2PKG



Backplate elbow female
 Muurplaat binnendraad
 Culasse femelle
 Wandscheibe IG

Article number	Bag / Box	Type	Subgroup
2PKG-1603	10 pc. / 50 pc.	16x3/8" (56 mm)	
2PKG-1604BP*	10 pc. / 50 pc.	16x1/2" (56 mm)	
2PKG-2004BP*	10 pc. / 50 pc.	20x1/2" (56 mm)	
2PKG-2005	5 pc. / 30 pc.	20x3/4" (56 mm)	
2PKG-2605	5 pc. / 30 pc.	26x3/4" (56 mm)	

* With black plug BP04 1/2"

Type: 2PKG-K



Backplate elbow female, short model
 Muurplaat binnendraad, laag
 Culasse femelle, modèle court
 Wandscheibe IG, kurzes Modell

Article number	Bag / Box	Type	Subgroup
2PKG-1604KBP*	10 pc. / 50 pc.	16x1/2" (40 mm)	

* With black plug BP04 1/2"



Type: 3PKG



Double backplate elbow female, short model
 Muurplaat binnendraad dubbel, laag
 Culasse double, modèle court
 Wandscheibe doppelt IG, kurzes Modell

Article number	Bag / Box	Type	Subgroup
3PKG-160416BP*	10 pc. / 30 pc.	16x1/2"x16 (40 mm)	
3PKG-200420BP*	10 pc. / 30 pc.	20x1/2"x20 (40 mm)	

* With black plug BP04 1/2"

Type: 5PKG



Bent 90° male adapter
 Knie 90° buitendraad
 Coude 90° mâle
 Winkel 90° AG

Article number	Bag / Box	Type	Subgroup
5PKG-1604	10 pc. / 60 pc.	16x1/2"	
5PKG-2004	10 pc. / 60 pc.	20x1/2"	
5PKG-2005	10 pc. / 50 pc.	20x3/4"	
5PKG-2605	10 pc. / 40 pc.	26x3/4"	
5PKG-3206	5 pc. / 20 pc.	32x1"	
5PKG-4007	5 pc. / 15 pc.	40x1, 1/4"	

Type: 6PKG



Bent 90° female adapter
 Knie 90° binnendraad
 Coude 90° femelle
 Winkel 90° IG

Article number	Bag / Box	Type	Subgroup
6PKG-1604BP*	10 pc. / 60 pc.	16x1/2"	
6PKG-2004BP*	10 pc. / 60 pc.	20x1/2"	
6PKG-2005	10 pc. / 50 pc.	20x3/4"	
6PKG-2605	10 pc. / 50 pc.	26x3/4"	
6PKG-3206	5 pc. / 20 pc.	32x1"	
6PKG-4007	5 pc. / 15 pc.	40x1, 1/4"	

* With black plug BP04 1/2"

Type: 9PKG



T-piece
 T-stuk
 Pièce en T
 T-Stück

Article number	Bag / Box	Type	Subgroup
9PKG-161616	10 pc. / 60 pc.	16x16x16	
9PKG-202020	10 pc. / 50 pc.	20x20x20	
9PKG-262626	5 pc. / 30 pc.	26x26x26	
9PKG-323232	5 pc. / 15 pc.	32x32x32	
9PKG-404040	5 pc. / 10 pc.	40x40x40	

- 1
- 2
- 3
- 4
- 5
- 6
- 7
- 8
- 9
- 10
- 11

Type: 10PKG



T-reduced centre
T-verlopend
Pièce en T réduit
T-reduziert

Article number	Bag / Box	Type	Subgroup
10PKG-201620	10 pc. / 50 pc.	20x16x20	
10PKG-261626	5 pc. / 30 pc.	26x16x26	
10PKG-262026	5 pc. / 30 pc.	26x20x26	
10PKG-321632	5 pc. / 25 pc.	32x16x32	
10PKG-322032	5 pc. / 25 pc.	32x20x32	
10PKG-322632	5 pc. / 20 pc.	32x26x32	
10PKG-401640	5 pc. / 15 pc.	40x16x40	
10PKG-402040	5 pc. / 15 pc.	40x20x40	
10PKG-402640	5 pc. / 15 pc.	40x26x40	
10PKG-403240	5 pc. / 10 pc.	40x32x40	

Type: 11PKG



T-branch and line reduced
T-2X verlopend
Pièce en T 2X réduit
T-2X reduziert

Article number	Bag / Box	Type	Subgroup
11PKG-201616	10 pc. / 50 pc.	20x16x16	
11PKG-202016	10 pc. / 50 pc.	20x20x16	
11PKG-261620	5 pc. / 30 pc.	26x16x20	
11PKG-262016	5 pc. / 30 pc.	26x20x16	
11PKG-262020	5 pc. / 30 pc.	26x20x20	
11PKG-262616	5 pc. / 30 pc.	26x26x16	
11PKG-262620	5 pc. / 30 pc.	26x26x20	
11PKG-322026	5 pc. / 20 pc.	32x20x26	
11PKG-322626	5 pc. / 20 pc.	32x26x26	
11PKG-402032	5 pc. / 15 pc.	40x20x32	
11PKG-402632	5 pc. / 15 pc.	40x26x32	
11PKG-403232	5 pc. / 10 pc.	40x32x32	
11PKG-404026	5 pc. / 10 pc.	40x40x26	
11PKG-404032	5 pc. / 10 pc.	40x40x32	

Type: 12PKG



T-enlarged branch
T-vergroot
Pièce en T agrandi
Terweitert

Article number	Bag / Box	Type	Subgroup
12PKG-162016	10 pc. / 50 pc.	16x20x16	
12PKG-202620	5 pc. / 30 pc.	20x26x20	
12PKG-263226	5 pc. / 20 pc.	26x32x26	
12PKG-324032	5 pc. / 15 pc.	32x40x32	



Type: 13PKG



T-female branch
T-binnendraad
Pièce en T femelle
T-IG

Article number	Bag / Box	Type	Subgroup
13PKG-160416BP*	10 pc. / 50 pc.	16x1/2"x16	
13PKG-200420BP*	10 pc. / 50 pc.	20x1/2"x20	
13PKG-200520	10 pc. / 30 pc.	20x3/4"x20	
13PKG-260420BP*	5 pc. / 30 pc.	26x1/2"x20	
13PKG-260426BP*	5 pc. / 30 pc.	26x1/2"x26	
13PKG-260526	5 pc. / 30 pc.	26x3/4"x26	
13PKG-320532	5 pc. / 15 pc.	32x3/4"x32	
13PKG-320632	5 pc. / 10 pc.	32x1"x32	
13PKG-320732	5 pc. / 10 pc.	32x1,1/4"x32	
13PKG-400640	5 pc. / 10 pc.	40x1"x40	
13PKG-400740	5 pc. / 10 pc.	40x1,1/4"x40	

* With black plug BP04 1/2"

Type: 14PKG



T-male branch
T-buitendraad
Pièce en T mâle
T-AG

Article number	Bag / Box	Type	Subgroup
14PKG-160416	10 pc. / 50 pc.	16x1/2"x16	
14PKG-200420	10 pc. / 40 pc.	20x1/2"x20	
14PKG-200520	10 pc. / 30 pc.	20x3/4"x20	
14PKG-260426	5 pc. / 30 pc.	26x1/2"x26	
14PKG-260526	5 pc. / 25 pc.	26x3/4"x26	
14PKG-260626	5 pc. / 20 pc.	26x1"x26	
14PKG-320532	5 pc. / 15 pc.	32x3/4"x32	
14PKG-400740	5 pc. / 10 pc.	40x1,1/4"x40	

Type: 15PKG



Straight coupling
Doorverbinder recht / perssok
Manchon
Kupplung

Article number	Bag / Box	Type	Subgroup
15PKG-1616	10 pc. / 150 pc.	16x16	
15PKG-2020	10 pc. / 80 pc.	20x20	
15PKG-2626	5 pc. / 50 pc.	26x26	
15PKG-3232	5 pc. / 30 pc.	32x32	
15PKG-4040	5 pc. / 25 pc.	40x40	

- 1
- 2
- 3
- 4
- 5
- 6
- 7
- 8
- 9
- 10
- 11

Type: 16PKG



Reducing coupling
Verloopstuk
Réduction
Kupplung-reduziert

Article number	Bag / Box	Type	Subgroup
16PKG-2016	10 pc. / 100 pc.	20x16	
16PKG-2616	5 pc. / 60 pc.	26x16	
16PKG-2620	5 pc. / 50 pc.	26x20	
16PKG-3216	5 pc. / 50 pc.	32x16	
16PKG-3220	5 pc. / 40 pc.	32x20	
16PKG-3226	5 pc. / 40 pc.	32x26	
16PKG-4026	5 pc. / 30 pc.	40x26	
16PKG-4032	5 pc. / 25 pc.	40x32	

Type: 17PKG



Straight male adapter
Recht aansluitstuk buitendraad / Puntstuk
Raccord droit mâle
Übergangsstücking AG

Article number	Bag / Box	Type	Subgroup
17PKG-1604	10 pc. / 80 pc.	16x1/2"	
17PKG-2004	10 pc. / 80 pc.	20x1/2"	
17PKG-2005	10 pc. / 50 pc.	20x3/4"	
17PKG-2605	10 pc. / 50 pc.	26x3/4"	
17PKG-2606	10 pc. / 40 pc.	26x1"	
17PKG-3206	10 pc. / 40 pc.	32x1"	
17PKG-3207	5 pc. / 25 pc.	32x1, 1/4"	
17PKG-4006	5 pc. / 25 pc.	40x1"	
17PKG-4007	5 pc. / 25 pc.	40x1, 1/4"	

Type: 18PKG



Straight female adapter
Recht aansluitstuk binnendraad / Schroefbus
Raccord droit femelle
Übergangsstücking IG

Article number	Bag / Box	Type	Subgroup
18PKG-1604	10 pc. / 80 pc.	16x1/2"	
18PKG-2004	10 pc. / 80 pc.	20x1/2"	
18PKG-2005	10 pc. / 50 pc.	20x3/4"	
18PKG-2605	10 pc. / 50 pc.	26x3/4"	
18PKG-2606	10 pc. / 40 pc.	26x1"	
18PKG-3206	10 pc. / 40 pc.	32x1"	
18PKG-3207	5 pc. / 25 pc.	32x1, 1/4"	
18PKG-4006	5 pc. / 25 pc.	40x1"	
18PKG-4007	5 pc. / 25 pc.	40x1, 1/4"	



Type: 27PKG



45° bend
Bocht 45°
Coude 45°
Winkel 45°

Article number	Bag / Box	Type	Subgroup
27PKG4040	5 pc. / 25 pc.	40x40	

1

2

3

4

5

6

7

8

9

10

11

Detailed overview of Super Size possibilities

A = 75mm

B = 90-110mm

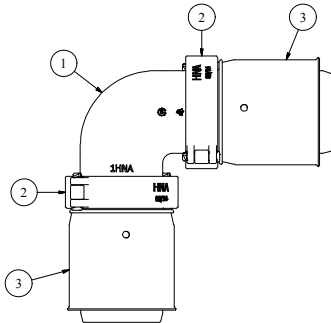

1PK

- 1 1HNA or 1HNB
- 2 HNA or HNB
- 3 8HNA-PK40 or 8HNA-PK50 or 8HNA-PK63 or 8HNA-PK75 or 8HNB-PK90

Example / Voorbeeld / Exemple / Beispiel

1PK-7575 = 1x 1HNA + 2xHNA + 2x 8HNA-PK75

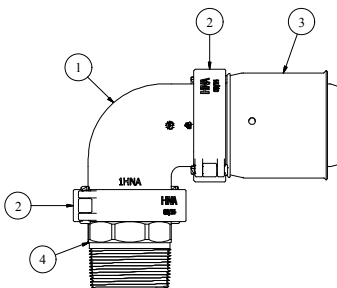

5PK / 6PK

- 1 1HNA or 1HNB
- 2 HNA or HNB
- 3 8HNA-PK75 or 8HNB-PK90
- 4 17HNA-10 or 17HNA-12 or 18HNA-06 or 18HNA-10 or 18HNA-12 or 18HNB-14

Example / Voorbeeld / Exemple / Beispiel

5PK-7510 = 1x 1HNA + 2xHNA + 1x 8HNA-PK75 + 1x17HNA-10

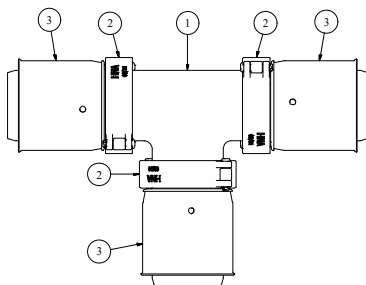

9PK / 10PK / 11PK / 12PK (75mm)

- 1 9HNA
- 2 HNA
- 3 8HNA-PK40 or 8HNA-PK50 or 8HNA-PK63 or 8HNA-PK75

Example / Voorbeeld / Exemple / Beispiel

9PK-757575 = 1x 9HNA + 3xHNA + 3x 8HNA-PK75

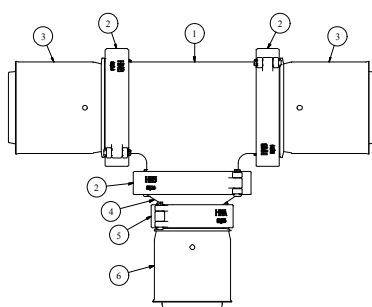

10PK / 11PK / 12PK (90mm)

- 1 9HNB
- 2 HNB
- 3 8HNB-PK90
- 4 16HNAB
- 5 HNA
- 6 8HNA-PK40 or 8HNA-PK50 or 8HNA-PK63 or 8HNA-PK75

Example

10PK-905090 = 1x 9HNB + 3x HNB + 2x 8HNB-PK90 + 1x 16HNAB + 1xHNA + 8HNA-PK50

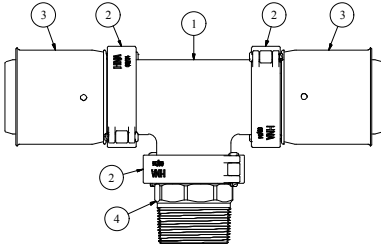

13PK / 14PK

- ① 9HNA or 9HNB
- ② HNA or HNB
- ③ 8HNA-PK75 or 8HNB-PK90
- ④ 17HNA-10 or 17HNA-12 or 18HNA-06 or 18HNA-10 or 18HNA-12 or 18HNB-14

Example / Voorbeeld / Exemple / Beispiel

13PK-750675 = 1x 9HNA + 3x HNA + 8HNA-PK75 + 18HNA-06

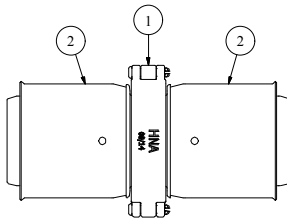

15PK / 16PK

- ① HNA or HNB
- ② 8HNA-PK75 or 8HNB-PK90

Example / Voorbeeld / Exemple / Beispiel

15PK-7575 = 1x HNA + 2x 8HNA-PK75

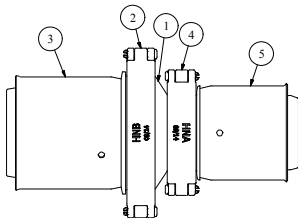

16PK

- ① 16HNAB
- ② HNB
- ③ 8HNB-PK90
- ④ HNA
- ⑤ 8HNA-PK40 or 8HNA-PK50 or 8HNA-PK63 or 8HNA-PK75

Example / Voorbeeld / Exemple / Beispiel

16PK-9063 = 1x 16HNAB + 1x HNB + 1x 8HNB-PK90 + 1x HNA + 1x 8HNA-PK63

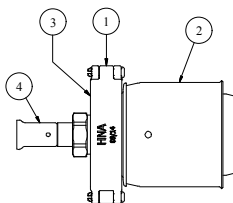

16PK-7516

- ① HNA
- ② 8HNA-PK75
- ③ HNA-EK05
- ④ 19P-1605 or 19P-1805 or 19P-2005 or 33P-1605 or 19SK-1605 or 19SK-2005

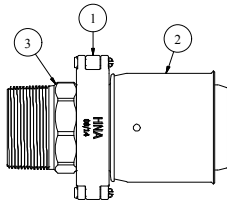

17PK / 18PK

- ① HNA or HNB
- ② 8HNA-PK40 or 8HNA-PK50 or 8HNA-PK63 8HNA-PK75 or 8HNB-PK90
- ③ 17HNA-10 or 17HNA-12 or 18HNB-06 or 18HNB-10 or 18HNB-12 or 18HNB-14

Example / Voorbeeld / Exemple / Beispiel

18PK-7512 = 1x HNA + 1x 8HNA-PK75 + 1x 18HNA-12

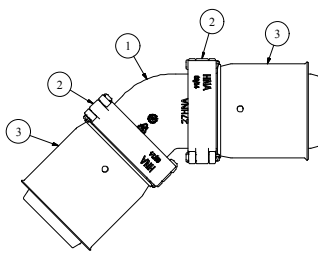

27PK

- ① 27HNA or 27HNB
- ② HNA or HNB
- ③ 8HNA-PK75 or 8HNB-PK90

Example / Voorbeeld / Exemple / Beispiel

27PK-9090 = 1x 27HNB + 2xHNB + 2x 8HNB-PK90

SUPER SIZE ASSEMBLY *HN connection = click and lock connection
*PK connection = press connection

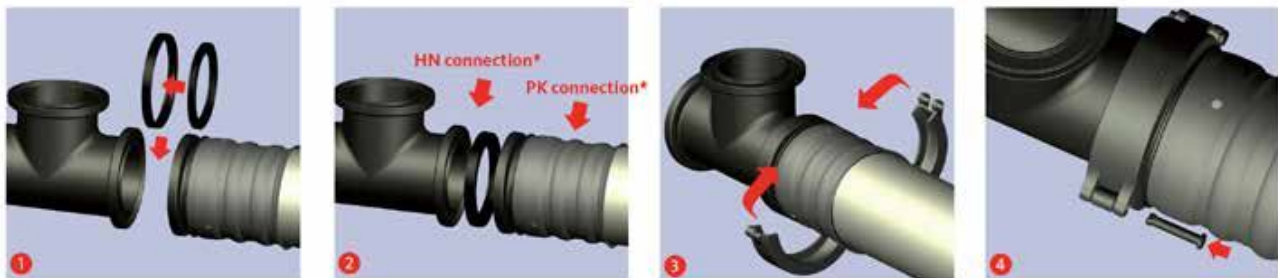



Type: 1HN



Elbow 90°
Knie 90°
Coude 90°
Winkel 90°

Article number	Bag / Box	Type	Subgroup
1HNA	1 pc. / 10 pc.	HNAxHNA	
• 1HNB	1 pc. / 1 pc.	HNBxHNB	

- 1
- 2
- 3
- 4
- 5
- 6
- 7
- 8
- 9
- 10
- 11

Type: 9HN



T-piece
T-stuk
Pièce en T
T-Stuck

Article number	Bag / Box	Type	Subgroup
9HNA	1 pc. / 7 pc.	HNAxHNAxHNA	
• 9HNB	1 pc. / 1 pc.	HNBxHNBxHNB	

Type: 16HN



Reducing coupling
Verloopstuk
Réduction
Kupplung-reduziert

Article number	Bag / Box	Type	Subgroup
• 16HNA	1 pc. / 15 pc.	HNBxHNA	

Type: 27HN



Elbow 45°
Bocht 45°
Coude 45°
Winkel 45°

Article number	Bag / Box	Type	Subgroup
27HNA	1 pc. / 15 pc.	HNAxHNA	
• 27HNB	1 pc. / 1 pc.	HNBxHNB	

Type: 8HN



Pressfitting
 Persfitting
 Raccord à sertir
 Pressfitting

Article number	Bag / Box	Type	Subgroup
8HNA-FK40	1 pc. / 20 pc.	HNAx40	
8HNA-FK50	1 pc. / 15 pc.	HNAx50	
8HNA-FK63	1 pc. / 12 pc.	HNAx63	
8HNA-FK75	1 pc. / 12 pc.	HNAx75	
• 8HNB-FK90	1 pc. / 4 pc.	HNBx90	

Type: HN



Bracket set
 Beugel set
 Support
 Bracket set

Article number	Bag / Box	Type	Subgroup
HNA	1 pc. / 1 pc.		
• HNB	1 pc. / 1 pc.		

Type: HN-PEN



Locking pin
 Beugelpin
 Goupille de verrouillage
 Sicherungsstift

Article number	Bag / Box	Type	Subgroup
HN-PEN	50 pc. / 50 pc.		

Type: HN-U



Sealing ring
 Dichtingsring
 Anneau d'étanchéité
 Dichtungsring

Article number	Bag / Box	Type	Subgroup
HNA-U	10 pc. / 10 pc.	HNA	
• HNB-U	10 pc. / 10 pc.	HNB	



Type: 17HN



Brass adapter male
Messing adapter buitendraad
Raccord en laiton mâle
Brass adapter male

Article number	Bag / Box	Type	Subgroup
17HNA-10	1 pc. / 22 pc.	HNAx2"	
17HNA-12	1 pc. / 18 pc.	HNAx2,5"	

Type: 18HN



Brass adapter female
Messing adapter binnendraad
Raccord en laiton femelle
Brass adapter female

Article number	Bag / Box	Type	Subgroup
• HNA-EK05	1 pc. / -	HNAx3/4"EK	
18HNA-06	1 pc. / 40 pc.	HNAx1"	
18HNA-10	1 pc. / 27 pc.	HNAx2"	
18HNA-12	1 pc. / 16 pc.	HNAx2,5"	
• 18HNB-14	1 pc. / -	HNBx3"	

Type: HN-STOP



Stop end for Super Size range
Eindstop voor Super Size gamma
Bouchon d'arrêt Super Size
Endkappe für das Sortiment Super Size

Article number	Bag / Box	Type	Subgroup
HNA-STOP	1 pc. / -	HNA	
• HNB-STOP	1 pc. / -	HNB	

Type: HNA-EK05



Adapter HNA x EK 3/4"
Overgang HNA x EK 3/4"
Réduction HNA x EK 3/4"
Übergang HNA x EK 3/4"

Article number	Bag / Box	Type	Subgroup
• HNA-EK05	1 pc. / -	HNAx3/4" EK	

- 1
- 2
- 3
- 4
- 5
- 6
- 7
- 8
- 9
- 10
- 11



Type: HNA-ECOLINE-SET

Basic set for Inliner
Basisset voor Inliner
Set de base pour Inliner
Grundsatz für Inliner

Article number	Bag / Box	Type	Subgroup
• HNA-ECOLINE-SET	1 pc. / -		

Compostion:
1x 9HNA (T-piece)
4x HNA (Bracket set)
1x HNA-EK05 (Adapter HNA-EK)
1x HNA-INLB (Base plate for inliner)





The Henco ECO-line is an energy saving solution for recirculation loops, which limits heat loss between supply and return pipe.

A separate pipe for the circulation water is no longer required.

Designed on the Henco Super Size concept, it also combines modularity and easy installation.

ONE CONCEPT FOR ALL DIMENSIONS FROM 40 UP TO 75MM.

- Cost effective
- Easy installation
- Less space consumption
- Anti legionellosis

Necessary items to complete the ECOLINE installation

Article number	Description	Page
8HNA-FK..	Press fitting 40, 50, 63 or 75	44
100-MXC1620	Henco 1L PE-Xc 16x2 - 100m	-
19P-1605	Nickel plated press-fit adapter to eurocone 16x3/4"	67
19P-2005	Nickel plated press-fit adapter to eurocone 20x3/4"	67
33P-1605	Nickel plated press-fit adapter to eurocone 90°	72
19FK-1605	Press-fit swivel to eurocone 16x3/4"	31
19FK-2005	Press-fit swivel to eurocone 20x3/4"	31
19SK-1605	Push fitting with eurocone connection 16x3/4"	57
19SK-2005	Push fitting with eurocone connection 20x3/4"	57

- 1
- 2
- 3
- 4
- 5
- 6
- 7
- 8
- 9
- 10
- 11





	Page
A. FITTINGS	53
B. MANIFOLDS	59

A. FITTINGS



Type: 1SK



Elbow 90°
Knie 90°
Coude 90°
Winkel 90°

Article number	Bag / Box	Type	Subgroup
1SK-1616	10 pc. / 70 pc.	16x16	
1SK-2020	10 pc. / 50 pc.	20x20	
1SK-2626	5 pc. / 40 pc.	26x26	

1

2

3

4

5

6

7

8

9

10

11

Type: 2SK



Backplate elbow female
Sanitair muurplaat binnendraad
Culasse pour sanitaire femelle
Sanitär Wandscheibe IG

Article number	Bag / Box	Type	Subgroup
2SK-1604BP*	10 pc. / 40 pc.	16x1/2" (56 mm)	
2SK-2004BP*	10 pc. / 40 pc.	20X1/2" (56 mm)	
2SK-2005	10 pc. / 30 pc.	20X3/4" (56 mm)	
2SK-2605	5 pc. / 20 pc.	26X3/4" (56 mm)	

* With black plug BP04 1/2"

Type: H



Bracket for backplate
Tappuntbeugel voor muurplaat sanitair
Support pour culasse sanitaire
Halteplatte für Sanitär Wandscheibe

Article number	Bag / Box	Type	Subgroup
H716042005	10 pc. / 250 pc.	For: 2SK 3SK	

Type: 3SK



Double backplate elbow female, short model
Dubbel sanitair muurplaat binnendraad, laag
Culasse double pour sanitaire, modèle court
Sanitär Wandscheibe doppelt IG, kurzes Modell

Article number	Bag / Box	Type	Subgroup
3SK-160416BP*	10 pc. / 30 pc.	16X1/2" (40 mm)	
3SK-200420BP*	10 pc. / 30 pc.	20X1/2" (40 mm)	

* With black plug BP04 1/2"

A. FITTINGS

Type: 5SK



Bent 90° male adapter
Knie 90° buitendraad
Coude 90° mâle
Winkel 90° AG

Article number	Bag / Box	Type	Subgroup
5SK-1604	10 pc. / 60 pc.	16X1/2"	
5SK-2004	10 pc. / 50 pc.	20X1/2"	
5SK-2005	10 pc. / 40 pc.	20X3/4"	
5SK-2605	5 pc. / 30 pc.	26X3/4"	

Type: 6SK



Bent 90° female adapter
Knie 90° binnendraad
Coude 90° femelle
Winkel 90° IG

Article number	Bag / Box	Type	Subgroup
6SK-1604BP*	10 pc. / 60 pc.	16X1/2"	
6SK-2004BP*	10 pc. / 60 pc.	20X1/2"	
6SK-2005	10 pc. / 30 pc.	20X3/4"	
6SK-2605	10 pc. / 30 pc.	26X3/4"	

* With black plug BP04 1/2"

Type: 9SK



T-piece
T-stuk
Pièce en T
T-Stuck

Article number	Bag / Box	Type	Subgroup
9SK-161616	10 pc. / 40 pc.	16x16x16	
9SK-202020	10 pc. / 30 pc.	20x20x20	
9SK-262626	5 pc. / 20 pc.	26x26x26	

Type: 10SK



T-reduced centre
T-verlopend
Pièce en T réduit
T-reduziert

Article number	Bag / Box	Type	Subgroup
10SK-201620	10 pc. / 40 pc.	20x16x20	
10SK-261626	5 pc. / 25 pc.	26x16x26	
10SK-262026	5 pc. / 20 pc.	26x20x26	

A. FITTINGS



Type: 11SK



T-branch and line reduced
T-2X verlopend
Pièce en T 2X réduit
T-2X reduziert

Article number	Bag / Box	Type	Subgroup
11SK-201616	10 pc. / 40 pc.	20x16x16	
11SK-202016	10 pc. / 30 pc.	20x20x16	
11SK-261620	5 pc. / 25 pc.	26x16x20	
11SK-262016	5 pc. / 25 pc.	26x20x16	
11SK-262020	5 pc. / 25 pc.	26x20x20	
11SK-262616	5 pc. / 25 pc.	26x26x16	
11SK-262620	5 pc. / 20 pc.	26x26x20	

Type: 12SK



T-enlarged branch
T-vergroot
Pièce en T agrandi
T-erweitert

Article number	Bag / Box	Type	Subgroup
12SK-162016	10 pc. / 40 pc.	16x20x16	
12SK-202620	5 pc. / 30 pc.	20x26x20	

Type: 13SK



T-female centre
T-binnendraad
Pièce en T femelle
T-IG

Article number	Bag / Box	Type	Subgroup
13SK-160416BP*	10 pc. / 40 pc.	16x1/2"x16	
13SK-200420BP*	10 pc. / 30 pc.	20x1/2"x20	
13SK-200520	10 pc. / 30 pc.	20x3/4"x20	
13SK-260420BP*	5 pc. / 20 pc.	26x1/2"x20	
13SK-260426BP*	5 pc. / 20 pc.	26x1/2"x26	
13SK-260526	5 pc. / 20 pc.	26x3/4"x26	

* With black plug BP04 1/2"

Type: 14SK



T-male centre
T-buitendraad
Pièce en T mâle
T-AG

Article number	Bag / Box	Type	Subgroup
14SK-160416	10 pc. / 40 pc.	16x1/2"x16	
14SK-200420	10 pc. / 30 pc.	20x1/2"x20	
14SK-260426	5 pc. / 20 pc.	26x1/2"x26	



A. FITTINGS

Type: 15SK



Straight coupling
Doorverbinder recht
Manchon
Kupplung

Article number	Bag / Box	Type	Subgroup
15SK-1616	10 pc. / 70 pc.	16x16	
15SK-2020	10 pc. / 60 pc.	20x20	
15SK-2626	5 pc. / 30 pc.	26x26	

Type: 16SK



Reducing coupling
Verloopstuk
Réduction
Kupplung-reduziert

Article number	Bag / Box	Type	Subgroup
16SK-2016	10 pc. / 80 pc.	20x16	
16SK-2616	10 pc. / 50 pc.	26x16	
16SK-2620	10 pc. / 40 pc.	26x20	

Type: 17SK



Straight male adapter
Recht aansluitstuk buitendraad / Puntstuk
Raccord droit mâle
Übergangsfitting AG

Article number	Bag / Box	Type	Subgroup
17SK-1603	10 pc. / 80 pc.	16x3/8"	
17SK-1604	10 pc. / 80 pc.	16x1/2"	
17SK-2004	10 pc. / 60 pc.	20x1/2"	
17SK-2005	10 pc. / 60 pc.	20x3/4"	
17SK-2605	10 pc. / 40 pc.	26x3/4"	
17SK-2606	10 pc. / 40 pc.	26x1"	

Type: 18SK



Straight female adapter
Recht aansluitstuk binnendraad / Schroefbus
Raccord droit femelle
Übergangsfitting IG

Article number	Bag / Box	Type	Subgroup
18SK-1604	10 pc. / 80 pc.	16x1/2"	
18SK-2004	10 pc. / 80 pc.	20x1/2"	
18SK-2005	10 pc. / 60 pc.	20x3/4"	
18SK-2605	10 pc. / 50 pc.	26x3/4"	
18SK-2606	10 pc. / 40 pc.	26x1"	



Type: 17SKS



Straight nipple male (brass)
 Recht aansluitstuk buitendraad (messing)
 Raccord droit mâle (laiton)
 Übergangsfitting AG (Messing)

Article number	Bag / Box	Type	Subgroup
17SKS-2004	5 pc. / 150 pc.	20x1/2"	
17SKS-2005	5 pc. / 150 pc.	20x3/4"	
17SKS-2604	5 pc. / 100 pc.	26x1/2"	
17SKS-2605	5 pc. / 100 pc.	26x3/4"	

Applicable with HENCO Vision fittings & manifolds

Type: 18SKS



Straight nipple female (brass)
 Recht aansluitstuk binnendraad (messing)
 Raccord droit femelle (laiton)
 Übergangsfitting IG (Messing)

Article number	Bag / Box	Type	Subgroup
18SKS-2004	5 pc. / 150 pc.	20x1/2"	
18SKS-2005	5 pc. / 100 pc.	20x3/4"	
18SKS-2604	5 pc. / 100 pc.	26x1/2"	
18SKS-2605	5 pc. / 80 pc.	26x3/4"	

Applicable with HENCO Vision fittings & manifolds

Type: 19SK



Push fitting with eurocone connection
 Steekkoppeling met euroconus-aansluiting
 Raccord push fit avec eurocone
 Steckkupplung mit Eurokonus

Article number	Bag / Box	Type	Subgroup
19SK-1605	10 pc. / 80 pc.	16x3/4" EK	
19SK-2005	10 pc. / 80 pc.	20x3/4" EK	

Type: 26SK



Push fitting with swivel and flat sealing
 Steekkoppeling met wartel en vlakke dichting
 Raccord push fit avec raccord ecrou étanchéité plate
 Steckkupplung mit Drehbar und Flach Versiegelung

Article number	Bag / Box	Type	Subgroup
26SK-1605	10 pc. / 80 pc.	16x3/4"	
26SK-2005	10 pc. / 80 pc.	20x3/4"	



A. FITTINGS

Type: SK-PIPESTOP



Stop end for pipe
Eindstop voor buis
Bouchon pour tube
Endkappe für Rohre

Article number	Bag / Box	Type	Subgroup
SK-PIPESTOP16	10 pc. / 120 pc.	16	
SK-PIPESTOP20	10 pc. / 80 pc.	20	
SK-PIPESTOP26	10 pc. / 80 pc.	26	

Type: SK-STOPCLIP



Reusable stop and clip for push □ connection
Herbruikbare stop en clip passend in een steekkoppeling
Bouchon et clip réutilisables pour connection push □
Stopfen und clip für Steckanschluss, wieder verwendbar

Article number	Bag / Box	Type	Subgroup
SK-STOPCLIP16	10 pc. / 120 pc.	16	
SK-STOPCLIP20	10 pc. / 100 pc.	20	
SK-STOPCLIP26	10 pc. / 80 pc.	26	

Type: VISION SET



Vision revision set
Vision revisie set
Set de révision Vision
Vision set

Article number	Bag / Box	Type	Subgroup
VISION SET 16	1 pc. / 100 pc.	16	
VISION SET 20	1 pc. / 90 pc.	20	
VISION SET 26	1 pc. / 80 pc.	26	

Type: VISION KEY



Vision disassembly key
Vision demontage sleutel
Clé de démontage Vision
Vision Entriegelungsschlüssel

Article number	Bag / Box	Type	Subgroup
VISION-KEY16	1 pc. / 200 pc.	16	
VISION-KEY20	1 pc. / 200 pc.	20	
VISION-KEY26	1 pc. / 200 pc.	26	



Type: VSK-1616



Extension or body for manifold, two SK connections Ø16
 Verlengstuk of basis voor verdeler, twee SK-aansluitingen Ø16
 Complément ou base collecteur, deux sorties SK Ø16
 Erweiterung oder Basiskörper für Verteiler, zwei SK-Anschlüssen Ø16

Article number	Bag / Box	Type	Subgroup
VSK-1616	1 pc. / 14 pc.	1616	

1

2

3

4

5

6

7

8

Type: VSK-161616



Extension or body for manifold, three SK connections Ø16
 Verlengstuk of basis voor verdeler, drie SK-aansluitingen Ø16
 Complément ou base collecteur, trois sorties SK Ø16
 Erweiterung oder Basiskörper für Verteiler, drei SK-Anschlüssen Ø16

Article number	Bag / Box	Type	Subgroup
VSK-161616	1 pc. / 14 pc.	161616	

9

10

11

Type: VSKEK-0502



Extension or body for manifold, two eurocone connections
 Verlengstuk of basis voor verdeler, twee euroconus-aansluitingen
 Complément ou base collecteur, deux sorties eurocone
 Erweiterung oder Basiskörper für Verteiler, zwei Eurokonus-Anschlüssen

Article number	Bag / Box	Type	Subgroup
VSKEK-0502	10 pc. / 30 pc.	2x3/4"EK	

Type: VSKEK-0503



Extension or body for manifold, three eurocone connections
 Verlengstuk of basis voor verdeler, drie euroconus-aansluitingen
 Complément ou base collecteur, trois sorties eurocone
 Erweiterung oder Basiskörper für Verteiler, drei Eurokonus-Anschlüssen

Article number	Bag / Box	Type	Subgroup
VSKEK-0503	10 pc. / 30 pc.	3x3/4"EK	



B. MANIFOLDS

Type: 19SK



Push fitting with eurocone connection
 Steekkoppeling met euroconus-aansluiting
 Raccord push fit avec eurocone
 Steckkupplung mit Eurokonus

Article number	Bag / Box	Type	Subgroup
19SK-1605	10 pc. / 80 pc.	16x3/4" EK	
19SK-2005	10 pc. / 80 pc.	20x3/4" EK	

Type: VVSK



Straight entry piece
 Voeding voor verdeler
 Départ collecteur
 Eingang für Verteiler

Article number	Bag / Box	Type	Subgroup
WSK-20	10 pc. / 80 pc.	20	
WSK-26	10 pc. / 80 pc.	26	

Type: VVSK-TM



T-piece for supply for Vision manifold
 Aanvoer T-stuk voor Vision manifold
 Départ pièce en T collecteur Vision
 T-Stück für Vorlauf für Vision Verteiler

Article number	Bag / Box	Type	Subgroup
• WSK-T20M20	10 pc. / 30 pc.	20-20	
WSK-T26M26	5 pc. / 20 pc.	26-26	

Type: 17SKS



Straight nipple male (brass)
 Recht aansluitstuk buitendraad (messing)
 Raccord droit mâle (laition)
 Übergangsfitting AG (Messing)

Article number	Bag / Box	Type	Subgroup
17SKS-2004	5 pc. / 150 pc.	20 x 1/2"	
17SKS-2005	5 pc. / 150 pc.	20 x 3/4"	
17SKS-2604	5 pc. / 100 pc.	26 x 1/2"	
17SKS-2605	5 pc. / 100 pc.	26 x 3/4"	

Applicable with HENCO Vision fittings & manifolds

B. MANIFOLDS



Type: 18SKS



Straight nipple female (brass)
 Recht aansluitstuk binnendraad (messing)
 Raccord droit femelle (laiton)
 Übergangsstück IG (Messing)

Article number	Bag / Box	Type	Subgroup
18SKS-2004	5 pc. / 150 pc.	20 x 1/2"	
18SKS-2005	5 pc. / 100 pc.	20 x 3/4"	
18SKS-2604	5 pc. / 100 pc.	26 x 1/2"	
18SKS-2605	5 pc. / 80 pc.	26 x 3/4"	

Applicable with HENCO Vision fittings & manifolds

Type: VWSK-90



Bent 90° for manifold
 Knie 90° voor verdeler
 Coude 90° pour collecteur
 Winkel 90° für Verteiler

Article number	Bag / Box	Type	Subgroup
WSK-20-90	10 pc. / 70 pc.	20-90	
WSK-26-90	10 pc. / 50 pc.	26-90	

Type: VWSK-T



T for manifold
 T voor verdeler
 Piece en T pour collecteur
 T für Verteiler

Article number	Bag / Box	Type	Subgroup
WSK-T202020	10 pc. / 40 pc.	20-20-20	
WSK-T262626	10 pc. / 20 pc.	26-26-26	

Type: VS-ENDCAP



Endcap female for manifold
 Eindkap binnendraad voor verdeler
 Bouchon femelle pour collecteur
 Endkappe IG für Verteiler

Article number	Bag / Box	Type	Subgroup
VS-ENDCAP	10 pc. / 180 pc.	F	

- 1
- 2
- 3
- 4
- 5
- 6
- 7
- 8
- 9
- 10
- 11

B. MANIFOLDS

Type: VS-ENDCAP-M



End plugmale for manifold
Eindstop buitendraad voor verdeler
Bouchon mâle pour collecteur
Endkappe AG für Verteiler

Article number	Bag / Box	Type	Subgroup
VS-ENDCAP-M	10 pc. / 150 pc.	M	

Type: ENDCAP-EK05



Eurocone endcap 3/4" white
Euroconus-eindkap 3/4" wit
Eurocone bouchon 3/4" blanc
Eurokonus Endkappe 3/4" Weiss

Article number	Bag / Box	Type	Subgroup
• ENDCAP-EK05	10 pc. / 200 pc.	3/4" EK	

Type: VDSK



Straight female adapter for manifold or manifold extension
Doorverbinder voor montage op verdeler of verlengstuk
Manchon pour bout de collecteur
Ausgang für Verteiler

Article number	Bag / Box	Type	Subgroup
VDSK-20	10 pc. / 80 pc.	20	
VDSK-26	10 pc. / 60 pc.	26	

Type: SK-STOPCLIP



Reusable stop and clip for push-fit connection
Herbruikbare stop en clip passend in een steekkoppeling
Bouchon et clip réutilisables pour connection push-fit
Stopfen und clip für Steckanschluss, wieder verwendbar

Article number	Bag / Box	Type	Subgroup
SK-STOPCLIP16	10 pc. / 120 pc.	16	
SK-STOPCLIP20	10 pc. / 100 pc.	20	
SK-STOPCLIP26	10 pc. / 80 pc.	26	

B. MANIFOLDS



Type: SK-B05



Bracket for Vision manifolds
 Montagebeugel voor Vision verdelers
 Double support pour collecteurs Vision
 Halter für Vision Verteiler

Article number	pc/ Box	Typ	Subgroup
SK-B05	1 pc. / 200 pc.	B05	

- 1
- 2
- 3
- 4
- 5
- 6
- 7
- 8
- 9
- 10
- 11

POSSIBLE c OMBINATIONS

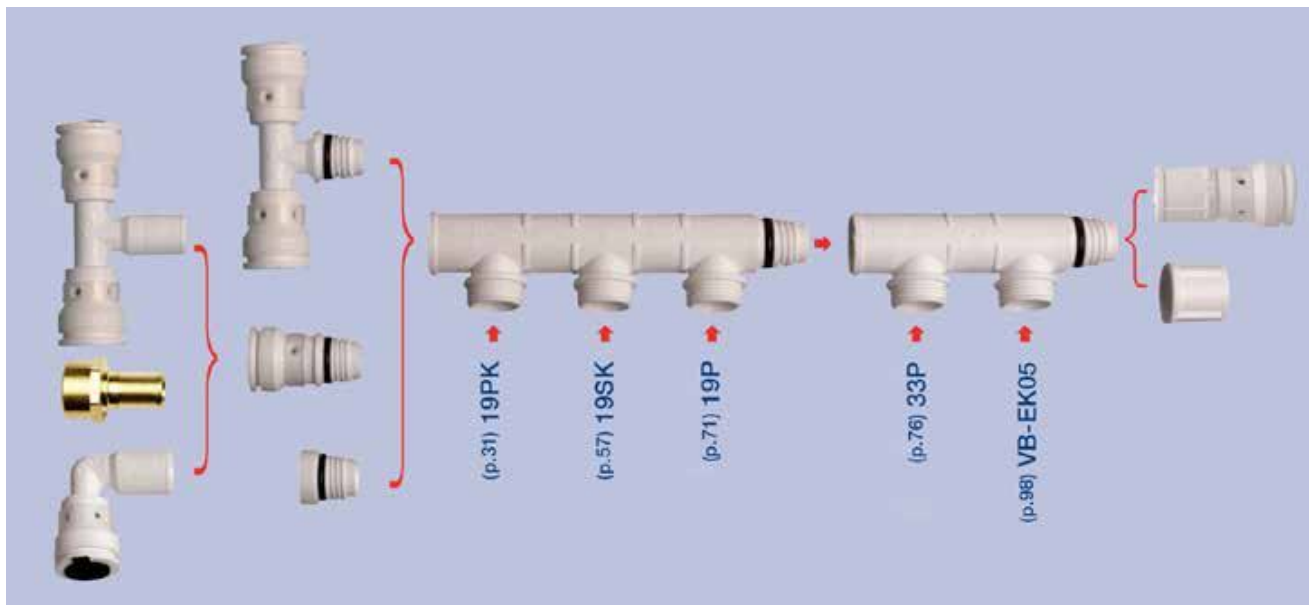

BRASS PRESS FITTINGS - MESSING PERSKOPPELINGEN - RACCORDS À SERTIR EN LAITON - MESSING PRESSFITTINGE



	Page
A. STANDARD	65
B. GAS	79

Certain fittings may differ from the images shown in this product overview



Type: 1P



Elbow 90°
Knie 90°
Coude 90°
Winkel 90°

Article number	Bag / Box	Type	Subgroup
1P-1414	10 pc. / 150 pc.	14x14	
1P-1616	10 pc. / 150 pc.	16x16	
1P-1818	10 pc. / 100 pc.	18x18	
1P-2020	10 pc. / 80 pc.	20x20	
1P-2626	5 pc. / 50 pc.	26x26	
1P-3232	5 pc. / 30 pc.	32x32	

- 1
- 2
- 3
- 4
- 5
- 6
- 7
- 8
- 9
- 10
- 11

Type: 2P



Backplate elbow female
Sanitair muurplaat binnendraad
Culasse pour sanitaire femelle
Sanitär Wandscheibe IG

Article number	Bag / Box	Type	Subgroup
2P-1604	10 pc. / 50 pc.	16x1/2" (52 mm)	
2P-1804	10 pc. / 50 pc.	18x1/2" (52 mm)	
2P-2004	10 pc. / 50 pc.	20x1/2" (52 mm)	
2P-2005	10 pc. / 50 pc.	20x3/4" (52 mm)	
2P-2605	5 pc. / 50 pc.	26x3/4" (52 mm)	

Type: 2P-K



Backplate elbow female, short model
Sanitair muurplaat binnendraad, laag
Culasse pour sanitaire femelle, modèle court
Sanitär Wandscheibe IG, kurzes Modell

Article number	Bag / Box	Type	Subgroup
2P-1404K	10 pc. / 50 pc.	14x1/2" (35 mm)	
2P-1604K	10 pc. / 50 pc.	16x1/2" (35 mm)	

Type: 3P



Double backplate elbow female
Sanitaire muurplaat binnendraad, dubbel
Culasse double pour sanitaire femelle
Sanitär Wandscheibe doppelt IG

Article number	Bag / Box	Type	Subgroup
3P-160416	10 pc. / 40 pc.	16x1/2"x16 (52 mm)	
3P-200420	10 pc. / 40 pc.	20x1/2"x20 (52 mm)	

A. STANDARD

Type: 3PM-V



Double backplate female (low)
 Doorstroom muurplaat binnendraad
 Culasse double femelle (écoulement)
 Wandscheibe doppelt IG (Fluss)

Article number	Bag / Box	Type	Subgroup
• 3PM-160416V	5 pc. / 20 pc.	16x1/2"x16 (50 mm)	
• 3PM-200420V	5 pc. / 20 pc.	20x1/2"x20 (50 mm)	

Type: 3PM-VK



Double backplate female (low, short model)
 Doorstroom muurplaat binnendraad, laag
 Culasse double femelle (écoulement), modèle court
 Wandscheibe doppelt IG (Fluss), kurzes Modell

Article number	Bag / Box	Type	Subgroup
• 3PM-160416VK	5 pc. / 20 pc.	16x1/2"x16 (40 mm)	
• 3PM-200420VK	5 pc. / 20 pc.	20x1/2"x20 (40 mm)	

Type: 4P



Backplate elbow female, extended model
 Sanitair muurplaat binnendraad, hoog
 Culasse pour sanitaire femelle, modèle long
 Sanitär Wandscheibe IG, langes Modell

Article number	Bag / Box	Type	Subgroup
4P-1604	10 pc. / 40 pc.	16x1/2" (78 mm)	
4P-1804	10 pc. / 40 pc.	18x1/2" (78 mm)	
4P-2004	10 pc. / 40 pc.	20x1/2" (78 mm)	

Type: 5P



Bent 90° male adapter
 Knie 90° buitendraad
 Coude 90° mâle
 Winkel 90° AG

Article number	Bag / Box	Type	Subgroup
5P-1404	10 pc. / 150 pc.	14x1/2"	
5P-1603	10 pc. / 150 pc.	16x3/8"	
5P-1604	10 pc. / 150 pc.	16x1/2"	
5P-1804	10 pc. / 120 pc.	18x1/2"	
5P-2004	10 pc. / 100 pc.	20x1/2"	
5P-2005	10 pc. / 80 pc.	20x3/4"	
5P-2605	10 pc. / 60 pc.	26x3/4"	
5P-3206	8 pc. / 25 pc.	32x1"	



Type: 6P



Bent 90° female adapter
 Knie 90° binnendraad
 Coude 90° femelle
 Winkel 90° IG

Article number	Bag / Box	Type	Subgroup
6P-1404	10 pc. / 120 pc.	14x1/2"	
6P-1604	10 pc. / 120 pc.	16x1/2"	
6P-1804	10 pc. / 120 pc.	18x1/2"	
6P-2004	10 pc. / 120 pc.	20x1/2"	
6P-2005	10 pc. / 50 pc.	20x3/4"	
6P-2605	5 pc. / 50 pc.	26x3/4"	
6P-3206	5 pc. / 30 pc.	32x1"	

- 1
- 2
- 3
- 4
- 5
- 6
- 7
- 8
- 9
- 10
- 11

Type: 7P



Backplate elbow male
 Sanitair muurplaat buitendraad met binnendraad 1/2"
 Culasse pour sanitaire mâle
 Sanitär Wandscheibe AG

Article number	Bag / Box	Type	Subgroup
7P-1605	10 pc. / 30 pc.	16x3/4" (78 mm)	
7P-1805	10 pc. / 30 pc.	18x3/4" (78 mm)	
7P-2005	10 pc. / 30 pc.	20x3/4" (78 mm)	
7P-1605K	10 pc. / 30 pc.	16x3/4" (65 mm)	

Type: 8P



Sanitary adapter female
 Sanitair aansluitstuk met binnendraad
 Culasse pour sanitaire femelle
 UP-Spülkastenwinkel

Article number	Bag / Box	Type	Subgroup
8P-1604	10 pc. / 50 pc.	16x1/2"	

Type: 9P



T-piece
 T-stuk
 Piece en T
 T-Stück

Article number	Bag / Box	Type	Subgroup
9P-141414	10 pc. / 100 pc.	14x14x14	
9P-161616	10 pc. / 60 pc.	16x16x16	
9P-181818	10 pc. / 60 pc.	18x18x18	
9P-202020	10 pc. / 50 pc.	20x20x20	
9P-262626	5 pc. / 30 pc.	26x26x26	
9P-323232	1 pc. / 20 pc.	32x32x32	

Type: 10P



T-reduced centre
T-verlopend
Pièce en T réduit
T-reduziert

Article number	Bag / Box	Type	Subgroup
10P-161416	10 pc. / 50 pc.	16x14x16	
10P-181418	10 pc. / 50 pc.	18x14x18	
10P-181618	10 pc. / 60 pc.	18x16x18	
10P-201620	10 pc. / 50 pc.	20x16x20	
10P-201820	10 pc. / 50 pc.	20x18x20	
10P-261626	5 pc. / 30 pc.	26x16x26	
10P-261826	5 pc. / 30 pc.	26x18x26	
10P-262026	5 pc. / 30 pc.	26x20x26	
10P-321632	5 pc. / 20 pc.	32x16x32	
10P-321832	5 pc. / 20 pc.	32x18x32	
10P-322032	5 pc. / 20 pc.	32x20x32	
10P-322632	5 pc. / 20 pc.	32x26x32	

Type: 11P



T-branch and line reduced
T-2X verlopend
Pièce en T 2X réduit
T-2X reduziert

Article number	Bag / Box	Type	Subgroup
11P-161414	10 pc. / 60 pc.	16x14x14	
11P-181616	10 pc. / 50 pc.	18x16x16	
11P-201616	10 pc. / 50 pc.	20x16x16	
11P-201818	10 pc. / 50 pc.	20x18x18	
11P-202016	10 pc. / 50 pc.	20x20x16	
11P-261620	5 pc. / 30 pc.	26x16x20	
11P-262020	5 pc. / 30 pc.	26x20x20	
11P-262616	5 pc. / 30 pc.	26x26x16	
11P-262620	5 pc. / 30 pc.	26x26x20	
11P-322026	5 pc. / 20 pc.	32x20x26	
11P-322626	5 pc. / 20 pc.	32x26x26	

Type: 12P



T-enlarged branch
T-vergroot
Pièce en T agrandi
T-erweitert

Article number	Bag / Box	Type	Subgroup
12P-161816	10 pc. / 60 pc.	16x18x16	
12P-162016	10 pc. / 60 pc.	16x20x16	
12P-202620	5 pc. / 30 pc.	20x26x20	
12P-263226	5 pc. / 20 pc.	26x32x26	



Type: 13P



T-with female branch
T-binnendraad
Pièce en T femelle
T-IG

Article number	Bag / Box	Type	Subgroup
13P-160416	10 pc. / 60 pc.	16x1/2"x16	
13P-200420	10 pc. / 50 pc.	20x1/2"x20	
13P-200520	10 pc. / 30 pc.	20x3/4"x20	
13P-260420	5 pc. / 30 pc.	26x1/2"x20	
13P-260426	5 pc. / 30 pc.	26x1/2"x26	
13P-260526	5 pc. / 30 pc.	26x3/4"x26	
13P-320532	5 pc. / 20 pc.	32x3/4"x32	
13P-320632	5 pc. / 20 pc.	32x1"x32	
13P-320732	5 pc. / 20 pc.	32x1,1/4"x32	

- 1
- 2
- 3
- 4**
- 5
- 6
- 7
- 8
- 9
- 10
- 11

Type: 14P



T-with male branch
T-buitendraad
Pièce en T mâle
T-AG

Article number	Bag / Box	Type	Subgroup
14P-160416	10 pc. / 60 pc.	16x1/2"x16	
14P-180418	10 pc. / 60 pc.	18x1/2"x18	
14P-200420	10 pc. / 60 pc.	20x1/2"x20	
14P-200520	5 pc. / 30 pc.	20x3/4"x20	
14P-260426	5 pc. / 30 pc.	26x1/2"x26	
14P-260526	5 pc. / 30 pc.	26x3/4"x26	
14P-260626	5 pc. / 30 pc.	26x1"x26	
14P-320532	5 pc. / 20 pc.	32x3/4"x32	
14P-320632	5 pc. / 20 pc.	32x1"x32	

Type: 15P



Straight coupling
Doorverbinder recht / perssok
Manchon
Kupplung

Article number	Bag / Box	Type	Subgroup
15P-1414	10 pc. / 200 pc.	14x14	
15P-1616	10 pc. / 200 pc.	16x16	
15P-1717	10 pc. / 200 pc.	17x17	
15P-1818	10 pc. / 150 pc.	18x18	
15P-2020	10 pc. / 140 pc.	20x20	
15P-2626	5 pc. / 80 pc.	26x26	
15P-3232	5 pc. / 50 pc.	32x32	

Type: 16P



Reducing coupling
Verloopstuk
Réduction
Kupplung-reduziert

Article number	Bag / Box	Type	Subgroup
16P-1614	10 pc. / 150 pc.	16x14	
16P-1816	10 pc. / 150 pc.	18x16	
16P-2014	10 pc. / 150 pc.	20x14	
16P-2016	10 pc. / 150 pc.	20x16	
16P-2018	10 pc. / 150 pc.	20x18	
16P-2616	5 pc. / 100 pc.	26x16	
16P-2618	5 pc. / 100 pc.	26x18	
16P-2620	5 pc. / 80 pc.	26x20	
16P-3216	5 pc. / 60 pc.	32x16	
16P-3220	5 pc. / 60 pc.	32x20	
16P-3226	5 pc. / 60 pc.	32x26	

Type: 17P



Straight male adapter
Recht aansluitstuk buitendraad / Puntstuk
Raccord droit mâle
Übergangsstück AG

Article number	Bag / Box	Type	Subgroup
17P-1403	10 pc. / 250 pc.	14x3/8"	
17P-1404	10 pc. / 150 pc.	14x1/2"	
17P-1603	10 pc. / 150 pc.	16x3/8"	
17P-1604	10 pc. / 150 pc.	16x1/2"	
17P-1804	10 pc. / 150 pc.	18x1/2"	
17P-1805	10 pc. / 150 pc.	18x3/4"	
17P-2004	10 pc. / 150 pc.	20x1/2"	
17P-2005	10 pc. / 150 pc.	20x3/4"	
17P-2605	5 pc. / 80 pc.	26x3/4"	
17P-2606	5 pc. / 80 pc.	26x1"	
17P-3206	5 pc. / 50 pc.	32x1"	
17P-3207	5 pc. / 40 pc.	32x1, 1/4"	



Type: 18P



Straight female adapter
 Recht aansluitstuk binnendraad / Schroefbus
 Raccord droit femelle
 Übergangsfitting IG

Article number	Bag / Box	Type	Subgroup
18P-1404	10 pc. / 200 pc.	14x1/2"	
18P-1604	10 pc. / 150 pc.	16x1/2"	
18P-1804	10 pc. / 120 pc.	18x1/2"	
18P-1805	10 pc. / 100 pc.	18x3/4"	
18P-2004	10 pc. / 100 pc.	20x1/2"	
18P-2005	10 pc. / 100 pc.	20x3/4"	
18P-2605	5 pc. / 80 pc.	26x3/4"	
18P-2606	5 pc. / 70 pc.	26x1"	
18P-3206	5 pc. / 50 pc.	32x1"	
18P-3207	5 pc. / 30 pc.	32x1,1/4"	

- 1
- 2
- 3
- 4
- 5
- 6
- 7
- 8
- 9
- 10
- 11

Type: 19P



Nickel plated press-fit adapter to eurocone
 Aansluiting met wartel en euroconus-koppeling vernickeld
 Raccordement avec raccord à visser eurocone nickelé
 Anschlussverschraubung mit Eurokonus vernickelt

Article number	Bag / Box	Type	Subgroup
19P-1605	10 pc. / 150 pc.	16x3/4" EK	
19P-1805	10 pc. / 150 pc.	18x3/4" EK	
19P-2005	10 pc. / 140 pc.	20x3/4" EK	

Type: 20P



Fitting short model for plinth-heating
 Fitting laag model voor plintverwarming
 Raccord pour montage dans la plinthe
 Sockelleisten- Anschluss-Set kurz von unten

Article number	Bag / Box	Type	Subgroup
20P-1604	2 pc. / 10 pc.	16x1/2"	

TILL EXHAUSTION OF STOCK

Type: 21P



Elbow for plinthheating chrome-plated
 Bocht voor plintverwarming verchroomd
 Equerre chromée pour montage dans la plinthe
 Sockelleistenanschluss Winkel verchromt

Article number	Bag / Box	Type	Subgroup
21P-1504	2 pc. / 40 pc.	15x1/2"	

Type: 22P



T, radiator connection nickel-plated 300 mm copper pipe Ø15
 Radiatoraansluiting T vernikkeld met 300 mm koperbuis Ø15
 T, alimentation radiateur nickelé 300 mm tube de cuivre Ø15
 Heizkörperanschluss T vernickelt 300 mm Kupferrohr Ø15

Article number	Bag / Box	Type	Subgroup
22P-1404	2 pc. / 50 pc.	14x150u x14	
22P-1604	2 pc. / 50 pc.	16x150u x16	
22P-1804	2 pc. / 30 pc.	18x150u x18	
22P-2004	2 pc. / 30 pc.	20x150u x20	

Type: 23P



T, radiator connection nickel-plated 1100 mm copper pipe Ø15
 Radiatoraansluiting T vernikkeld met 1100 mm koperbuis Ø15
 T, alimentation radiateur nickelé 1100 mm tube de cuivre Ø15
 Heizkörperanschluss T vernickelt 1100 mm Kupferrohr Ø15

Article number	Tasche	Type	Subgroup
23P-1604	2 pc.	16x150u x16	
23P-1804	2 pc.	18x150u x18	
23P-2004	2 pc.	20x150u x20	

Type: 24P



Radiator connection nickel-plated 300 mm copper pipe Ø15
 Radiatoraansluitbocht vernikkeld met 300 mm koperbuis Ø15
 Alimentation radiateur nickelé 300 mm tube de cuivre Ø15
 Heizkörperanschluss vernickelt 300 mm Kupferrohr Ø15

Article number	Bag / Box	Type	Subgroup
24P-1604	2 pc. / 50 pc.	16x150u	
24P-1804	2 pc. / 50 pc.	18x150u	
24P-2004	2 pc. / 50 pc.	20x150u	

Type: 25P



Radiator connection nickel-plated 1100 mm copper pipe Ø15
 Radiatoraansluitbocht vernikkeld met 1100 mm koperbuis Ø15
 Alimentation radiateur nickelé 1100 mm tube de cuivre Ø15
 Heizkörperanschluss vernickelt 1100 mm Kupferrohr Ø15

Article number	Tasche	Type	Subgroup
25P-1604	2 pc.	16x150u	
25P-1804	2 pc.	18x150u	
25P-2004	2 pc.	20x150u	



Type: 26P



Union with flat seat
3-delige koppeling vlak dichtend
Raccord union à joint plat
Verschraubung flachdichtend

Article number	Bag / Box	Type	Subgroup
26P-1604	10 pc. / 100 pc.	16x1/2"	
26P-1605	10 pc. / 80 pc.	16x3/4"	
26P-1805	10 pc. / 80 pc.	18x3/4"	
26P-2004	10 pc. / 80 pc.	20x1/2"	
26P-2005	10 pc. / 70 pc.	20x3/4"	
26P-2605	5 pc. / 50 pc.	26x3/4"	
26P-2606	5 pc. / 40 pc.	26x1"	
26P-3206	5 pc. / 40 pc.	32x1"	

- 1
- 2
- 3
- 4**
- 5
- 6
- 7
- 8
- 9
- 10
- 11

Type: 26P-Z



Press fitting swivel adapter
Aansluiting met wartel, vlakke dichting
Raccord à visser, joint plat
Pressfitting mit IG flachdichtend ohne Nippel

Article number	Bag / Box	Type	Subgroup
26P-14Z04	10 pc. / 150 pc.	14x1/2"	
26P-16Z03	10 pc. / 150 pc.	16x3/8"	
26P-16Z04	10 pc. / 150 pc.	16x1/2"	
26P-16Z05	10 pc. / 80 pc.	16x3/4"	
26P-18Z05	10 pc. / 80 pc.	18x3/4"	
26P-20Z04	10 pc. / 150 pc.	20x1/2"	
26P-20Z05	10 pc. / 70 pc.	20x3/4"	
26P-26Z06	5 pc. / 40 pc.	26x1"	
26P-32Z06	5 pc. / 40 pc.	32x1"	
26P-32Z07	5 pc. / 40 pc.	32x1, 1/4"	

Type: N



Nipple for 26P-Z
Nippel voor 26P-Z
Nipple pour 26P-Z
Nippel für 26P-Z

Article number	Bag / Box	Type	Subgroup
N04	10 pc. / 250 pc.	1/2"	
N05	10 pc. / 200 pc.	3/4"	
• N0605	10 pc. / 120 pc.	1"x3/4"	

A. STANDARD

Type: 27P



45° bend
Bocht 45°
Coude 45°
Winkel 45°

Article number	Bag / Box	Type	Subgroup
27P-2626	5 pc. / 50 pc.	26x26	
27P-3232	5 pc. / 30 pc.	32x32	

Type: 28P



Double backplate elbow female, build-up
Dubbele muurplaat binnendraad, opbouw
Culasse double pour sanitaire femelle
Sanitär Wandscheibe doppelt IG, Oberbau

Article number	Bag / Box	Type	Subgroup
28P-14041604	2 pc. / 24 pc.	14x1/2"x16x1/2" (153)	
28P-16041604	2 pc. / 24 pc.	16x1/2"x16x1/2" (153)	

Type: 28PV



Double backplate elbow female, build-in
Dubbele muurplaat binnendraad, inbouw
Culasse double surélevé
Wandwinkel doppelt erhöht

Article number	Bag / Box	Type	Subgroup
28PV-16031603	2 pc. / 24 pc.	16x3/8"x16x3/8" (120)	
28PV-16041604	2 pc. / 20 pc.	16x1/2"x16x1/2" (153)	

Type: 28PF



Double backplate elbow female for plaster
Dubbel muurplaat binnendraad voor gips
Culasse double femelle pour plâtre
Wandscheibe doppelt IG für Gips

Article number	Bag / Box	Type	Subgroup
28PF-16041604	1 pc. / 1 pc.	16x1/2"x16x1/2"	



Type: 29P



Press-fit adapter with copper pipe for compression fittings
 Persfitting verlengd met koperbuis voor schroef fittingen
 Manchon à sertir avec tube en cuivre pour raccords à visser
 Pressfitting mit Kupferrohr für Schraubfittinge

Article number	Bag / Box	Type	Subgroup
• 29P-1612	10 pc. / 120 pc.	16x12 (50mm copper)	
29P-1615	10 pc. / 120 pc.	16x15 (50mm copper)	
• 29P-2018	10 pc. / 70 pc.	20x18 (50mm copper)	
29P-2022	10 pc. / 70 pc.	20x22 (50mm copper)	
29P-2622	10 pc. / 70 pc.	26x22 (50mm copper)	

Type: 30P



Press-fit adapter to copper compression
 Overgangsstuk Henco pers x koperbuis knelkoppeling
 Manchon à sertir x tube en cuivre manchon à visser
 Pressfitting x Klemmverbinder für Kupferrohr

Article number	Bag / Box	Type	Subgroup
30P-1614S	10 pc. / 120 pc.	16x14 Cu	
30P-1615S	10 pc. / 120 pc.	16x15 Cu	
30P-2022S	10 pc. / 100 pc.	20x22 Cu	
30P-2622S	10 pc. / 80 pc.	26x22 Cu	

Type: 40P



Press-fit elbow to copper compression
 Knie Henco pers x koperbuis knelkoppeling
 Coude à sertir x tube en cuivre manchon à visser, 90°
 Winkel Henco Press x Klemmverbinder für Kupferrohr

Article number	Bag / Box	Type	Subgroup
40P-1615S	10 pc. / 60 pc.	16x15 Cu	
40P-2022S	10 pc. / 60 pc.	20x22 Cu	
40P-2622S	10 pc. / 60 pc.	26x22 Cu	

Type: 31P



Double crossover tee
 Kruisingsvrij T-stuk
 Double T croisé
 Kreuzungs-T-Stück

Article number	Bag / Box	Type	Subgroup
31P-161616	1 pc. / 20 pc.	16x16x16	
31P-161620	1 pc. / 20 pc.	16x16x20	
31P-201616	1 pc. / 20 pc.	20x16x16	
31P-201620	1 pc. / 20 pc.	20x16x20	
31P-202020	1 pc. / 20 pc.	20x20x20	



Type: ISO-BOX



Insulation box for double crossover tee
 Isolatiebox voor kruisingsvrij T-Stuk
 Boîte d'isolation pour T croisé
 Isolierboxen für Kreuzungs-T-Stück

Article number	Box	Type	Subgroup
ISO-BOX	1 pc.	INSULATION BOX	

Type: 32P



Press-fit adapter to copper press (V-profile)
 Overgangsstuk Henco pers x koper pers (V-profiel)
 Manchon Henco à sertir x cuivre à sertir (profil V)
 Pressfitting Henco x Pressfitting für Kupferrohr (Presskontur V)

Article number	Bag / Box	Type	Subgroup
32P-1615P	10 pc. / 150 pc.	16x15Cu V-profile	
32P-2022P	10 pc. / 70 pc.	20x22Cu V-profile	
32P-2622P	5 pc. / 70 pc.	26x22Cu V-profile	

Type: 33P



Nickel plated press-fit adapter to eurocone, 90°
 Aansluiting met wartel en euroconus-koppeling vernickeld, 90°
 Raccord à visser eurocone nickelé, 90°
 Anschlussverschraubung mit Eurokonus vernickelt, 90°

Article number	Bag / Box	Type	Subgroup
33P-1605	10 pc. / 60 pc.	16x3/4" EK	

Type: 34P



Henco press swivel adapter with flat sealing, 90°
 Aansluiting met wartel vlakdichtend, 90°
 Raccord à visser joint plat, 90°
 Anschlussverschraubung mit AG flachdichtend, 90°

Article number	Bag / Box	Type	Subgroup
34P-1604	10 pc. / 120 pc.	16x1/2"	
34P-1605	10 pc. / 120 pc.	16x3/4"	
34P-2005	10 pc. / 80 pc.	20x3/4"	
34P-3206	5 pc. / 40 pc.	32x1"	



Type: 35P



Press-fit adapter to copper press (M-profile)
 Overgangsstuk Henco pers naar koper pers (M-profiel)
 Manchon à sertir vers cuivre à sertir (profil M)
 Pressfitting Henco zu Pressfitting für Kupferrohr (M-profil)

Article number	Bag / Box	Type	Subgroup
35P-1612P	10 pc. / 160 pc.	16x12Cu M-profile	
35P-1615P	10 pc. / 150 pc.	16x15Cu M-profile	
35P-2018P	10 pc. / 120 pc.	20x18Cu M-profile	
35P-2022P	10 pc. / 80 pc.	20x22Cu M-profile	
35P-2622P	5 pc. / 70 pc.	26x22Cu M-profile	
35P-3228P	5 pc. / 50 pc.	32x28Cu M-profile	

- 1
- 2
- 3
- 4
- 5
- 6
- 7
- 8
- 9
- 10
- 11

Type: 37P



Press-fit adapter to copper pipe, elbow
 Persfitting verlengd met koperbuis, knie
 Coude à sertir avec tube en cuivre soudé
 Pressfitting mit geschweisstem Kupferrohr, Winkel

Article number	Bag / Box	Type	Subgroup
37P-1412*	10 pc. / 60 pc.	14x12 (85mm)	
37P-1412L	10 pc. / 60 pc.	14x12 (227/200mm)	
37P-1612L	10 pc. / 60 pc.	16x12 (227/200mm)	
37P-1615L	10 pc. / 60 pc.	16x15 (227/200mm)	

** TILL EXHAUSTION OF STOCK*

Type: 38P



Double bend for radiator nickel-plated 300 mm copper pipe Ø15, open end
 Dubbele radiatorbocht koperbuis Ø15, 300 mm, vernikkeld, open einde
 Double courbe radiateur nickelé 300 mm tube en cuivre, bout ouvert
 Doppelter Heizkörperwinkel vernickelt 300 mm Kupferrohr Ø15, offen Ende

Article number	Bag / Box	Type	Subgroup
38P-160450	1 pc. / 8 pc.	16x1/2" (AS= 50 mm)	

TILL EXHAUSTION OF STOCK

Type: 39P



Double bend for radiator nickel-plated 300 mm copper pipe Ø15, connected end
 Dubbele radiatorbocht koperbuis Ø15, 300 mm, vernikkeld, doorverbonden einde
 Double courbe radiateur nickelé 300 mm tube en cuivre, bout rattaché
 Doppelter Heizkörperwinkel vernickelt 300 mm Kupferrohr Ø15, durchgestelltes Ende

Article number	Bag / Box	Type	Subgroup
39P-160450	1 pc. / 8 pc.	16x1/2" (AS= 50 mm)	

Interaxis 50 mm



A. STANDARD

Type: 52P



Easy mounting/re
Eenvoudige mont
Raccord montage
Einfache Montage

Article number

52P16

52P20

52P26

52P32

Mounting instructions

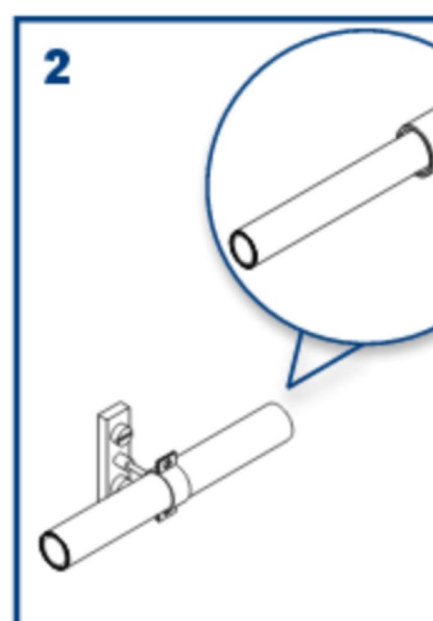
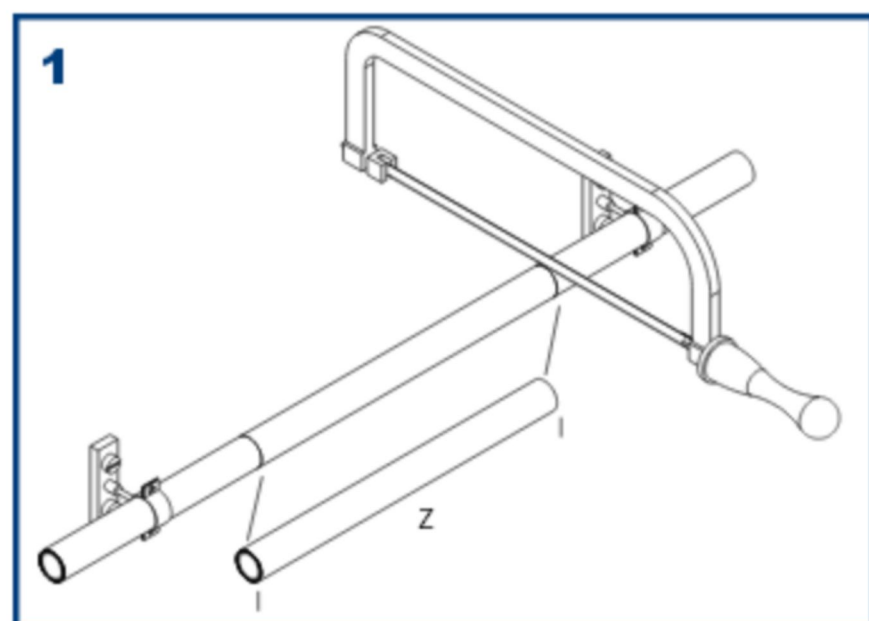

4

5



Gas: only allowed in countries where has been a HENCO GAS testing + certificate is available! (See www.henco.be)
 Gas: enkel toegelaten in landen waar er een HENCO GAS keur is + certificaat voorhanden is! (Zie www.henco.be)
 Gaz: seulement permis dans des pays où le contrôle a eu lieu + certificat est disponible! (Consultez www.henco.be)
 Gas: nur zugelassen in Länder wo HENCO GAS Prüfung geschehen ist + Zertifikat vorhanden ist! (Siehe www.henco.be)

Henco brass press fittings for gas in combination with standard pipes gas, see page 19



Type: 1PG



Elbow 90°
 Knie 90°
 Coude 90°
 Winkel 90°

Article number	Bag / Box	Type	Subgroup
1PG-1616	10 pc. / 150 pc.	16x16	
1PG-2020	10 pc. / 80 pc.	20x20	
1PG-2626	5 pc. / 50 pc.	26x26	
1PG-3232	5 pc. / 30 pc.	32x32	

Type: 2PG



Backplate elbow female
 Muurplaat binnendraad
 Culasse femelle
 Wandscheibe IG

Article number	Bag / Box	Type	Subgroup
2PG-1604	10 pc. / 50 pc.	16x1/2" (52 mm)	
2PG-2004	10 pc. / 50 pc.	20x1/2" (52 mm)	
2PG-2005	10 pc. / 50 pc.	20x3/4" (52mm)	
2PG-2605	5 pc. / 50 pc.	26x3/4" (52 mm)	

Type: 2PG-K



Backplate elbow female, short model
 Muurplaat binnendraad, laag
 Culasse femelle, modèle court
 Wandscheibe IG, kurzes Modell

Article number	Bag / Box	Type	Subgroup
2PG-1604K	10 pc. / 50 pc.	16x1/2" (40 mm)	

- 1
- 2
- 3
- 4
- 5
- 6
- 7
- 8
- 9
- 10
- 11

Type: 3PG



Double backplate elbow female
 Muurplaat binnendraad dubbel
 Culasse double
 Wandscheibe doppelt IG

Article number	Bag / Box	Type	Subgroup
3PG-160416	10 pc. / 40 pc.	16x1/2"x16 (52 mm)	
3PG-200420	10 pc. / 40 pc.	20x1/2"x20 (52 mm)	

Type: 5PG



Bent 90° male adapter
 Knie 90° buitendraad
 Coude 90° mâle
 Winkel 90° AG

Article number	Bag / Box	Type	Subgroup
5PG-1604	10 pc. / 150 pc.	16x1/2"	
5PG-2004	10 pc. / 100 pc.	20x1/2"	
5PG-2005	10 pc. / 80 pc.	20x3/4"	
5PG-2605	10 pc. / 60 pc.	26x3/4"	
5PG-3206	5 pc. / 25 pc.	32x1"	

Type: 6PG



Bent 90° female adapter
 Knie 90° binnendraad
 Coude 90° femelle
 Winkel 90° IG

Article number	Bag / Box	Type	Subgroup
6PG-1604	10 pc. / 120 pc.	16x1/2"	
6PG-2004	10 pc. / 120 pc.	20x1/2"	
6PG-2005	10 pc. / 50 pc.	20x3/4"	
6PG-2605	5 pc. / 50 pc.	26x3/4"	
6PG-3206	5 pc. / 30 pc.	6x1"	

Type: 9PG



T-piece
 T-stuk
 Pièce en T
 T-Stück

Article number	Bag / Box	Type	Subgroup
9PG-161616	10 pc. / 60 pc.	16x16x16	
9PG-202020	10 pc. / 50 pc.	20x20x20	
9PG-262626	5 pc. / 30 pc.	26x26x26	
9PG-323232	1 pc. / 20 pc.	32x32x32	



Type: 10PG



T-reduced centre
T-verlopend
Pièce en T-réduit
T-reduziert

Article number	Bag / Box	Type	Subgroup
10PG-201620	10 pc. / 50 pc.	20x16x20	
10PG-261626	5 pc. / 30 pc.	26x16x26	
10PG-262026	5 pc. / 30 pc.	26x20x26	
10PG-321632	5 pc. / 20 pc.	32x16x32	
10PG-322032	5 pc. / 20 pc.	32x20x32	
10PG-322632	5 pc. / 20 pc.	32x26x32	

Type: 11PG



T-branch and line reduced
T-2X verlopend
Pièce en T 2X réduit
T-2X reduziert

Article number	Bag / Box	Type	Subgroup
11PG-201616	10 pc. / 50 pc.	20x16x16	
11PG-202016	10 pc. / 50 pc.	20x20x16	
11PG-261620	5 pc. / 30 pc.	26x16x20	
11PG-262020	5 pc. / 30 pc.	26x20x20	
11PG-262616	5 pc. / 30 pc.	26x26x16	
11PG-322626	5 pc. / 20 pc.	32x26x26	

Type: 12PG



T-enlarged branch
T-vergroot
Pièce en T agrandi
T-erweitert

Article number	Bag / Box	Type	Subgroup
12PG-162016	10 pc. / 60 pc.	16x20x16	
12PG-202620	5 pc. / 30 pc.	20x26x20	
12PG-263226	5 pc. / 20 pc.	26x32x26	

Type: 13PG



T-female centre
T-binnendraad
Pièce en T femelle
T-IG

Article number	Bag / Box	Type	Subgroup
13PG-160416	10 pc. / 60 pc.	16x1/2"x16	
13PG-200420	10 pc. / 50 pc.	20x1/2"x20	
13PG-200520	10 pc. / 30 pc.	20x3/4"x20	
13PG-260426	5 pc. / 30 pc.	26x1/2"x26	
13PG-260526	5 pc. / 30 pc.	26x3/4"x26	
13PG-320632	5 pc. / 20 pc.	32x1"x32	

- 1
- 2
- 3
- 4
- 5
- 6
- 7
- 8
- 9
- 10
- 11

Type: 15PG



Straight coupling
 Doorverbinder recht / perssok
 Manchon
 Kupplung

Article number	Bag / Box	Type	Subgroup
15PG-1616	10 pc. / 200 pc.	16x16	
15PG-2020	10 pc. / 140 pc.	20x20	
15PG-2626	5 pc. / 80 pc.	26x26	
15PG-3232	5 pc. / 50 pc.	32x32	

Type: 16PG



Reducing coupling
 Verloopstuk
 Réduction
 Kupplung-reduziert

Article number	Bag / Box	Type	Subgroup
16PG-2016	10 pc. / 150 pc.	20x16	
16PG-2616	5 pc. / 100 pc.	26x16	
16PG-2620	5 pc. / 80 pc.	26x20	
16PG-3216	5 pc. / 60 pc.	32x16	
16PG-3220	5 pc. / 60 pc.	32x20	
16PG-3226	5 pc. / 40 pc.	32x26	

Type: 17PG



Straight male adapter
 Recht aansluitstuk buitendraad / Puntstuk
 Raccord droit mâle
 Übergangsstücking AG

Article number	Bag / Box	Type	Subgroup
17PG-1604	10 pc. / 150 pc.	16x1/2"	
17PG-2004	10 pc. / 150 pc.	20x1/2"	
17PG-2005	10 pc. / 150 pc.	20x3/4"	
17PG-2605	5 pc. / 80 pc.	26x3/4"	
17PG-2606	5 pc. / 80 pc.	26x1"	
17PG-3206	5 pc. / 50 pc.	32x1"	

Type: 18PG



Straight female adapter
 Recht aansluitstuk binnendraad / Schroefbus
 Raccord droit femelle
 Übergangsstücking IG

Article number	Bag / Box	Type	Subgroup
18PG-1604	10 pc. / 150 pc.	16x1/2"	
18PG-2004	10 pc. / 100 pc.	20x1/2"	
18PG-2005	10 pc. / 100 pc.	20x3/4"	
18PG-2605	5 pc. / 80 pc.	26x3/4"	
18PG-2606	5 pc. / 50 pc.	26x1"	
18PG-3206	5 pc. / 50 pc.	32x1"	



Type: 26PG-Z



Press fitting swivel adapter
 Aansluiting met wartel, vlakke dichting
 Raccord à visser, joint plat
 Pressfitting mit IG Flachdichtend ohne Nippel

Article number	Bag / Box	Type	Subgroup
26PG-16Z04	10 pc. / 150 pc.	16x1/2"	
26PG-16Z05	10 pc. / 80 pc.	16x3/4"	
26PG-20Z05	10 pc. / 70 pc.	20x3/4"	
26PG-26Z06	5 pc. / 40 pc.	26x1"	
26PG-32Z07	5 pc. / 40 pc.	32x1, 1/4"	

Type: 30PG



Press-fit adapter to copper compression
 Overgangsstuk Henco pers x koperbuis knelkoppeling
 Manchon henco à sertir x tube de cuivre manchon à visser
 Pressfitting x Klemmverbinder für Kupferrohr

Article number	Bag / Box	Type	Subgroup
30PG-1615S	10 pc. / 120 pc.	16x15 Cu	
30PG-2022S	10 pc. / 100 pc.	20x22 Cu	
30PG-2622S	10 pc. / 80 pc.	26x22 Cu	

- 1
- 2
- 3
- 4
- 5
- 6
- 7
- 8
- 9
- 10
- 11

**BRASS COMPRESSION FITTINGS - MESSING SCHROEFKOPPELINGEN
- RACCORDS À VISSER - SCHRAUBFITTINGE**



Certain fittings may differ from the images shown in this product overview



Type: 1



Straight male adapter
 Recht aansluitstuk buitendraad / Puntstuk
 Raccord droit mâle
 Kupplung AG

Article number	Bag / Box	Type	Subgroup
1-1403C*	10 pc. / 250 pc.	14x3/8" + o-ring	
1-1404	10 pc. / 250 pc.	14x1/2" + o-ring	
1-1604	10 pc. / 180 pc.	16x1/2" + o-ring	
1-1604Z	10 pc. / 250 pc.	16x1/2"	
1-1605	10 pc. / 150 pc.	16x3/4"	
1-1804	10 pc. / 150 pc.	18x1/2" + o-ring	
1-1805	10 pc. / 150 pc.	18x3/4"	
1-2004	10 pc. / 150 pc.	20x1/2" + o-ring	
1-2004Z	10 pc. / 150 pc.	20x1/2"	
1-2005	10 pc. / 150 pc.	20x3/4"	
1-2605	5 pc. / 80 pc.	26x3/4"	
1-2606	5 pc. / 80 pc.	26x1"	
1-3206	5 pc. / 80 pc.	32x1"	

* FOR FUEL OIL

- 1
- 2
- 3
- 4
- 5
- 6
- 7
- 8
- 9
- 10
- 11

Type: 2



Straight coupling
 Doorverbinder recht
 Manchon
 Kupplung doppelt

Article number	Bag / Box	Type	Subgroup
2-1414	10 pc. / 200 pc.	14x14	
2-1616	10 pc. / 200 pc.	16x16	
2-1818	10 pc. / 120 pc.	18x18	
2-2020	10 pc. / 120 pc.	20x20	
2-2626	5 pc. / 60 pc.	26x26	
2-3232	5 pc. / 40 pc.	32x32	

Type: 3



Straight female adapter
 Recht aansluitstuk binnendraad / Schroefbus
 Raccord droit femelle
 Kupplung IG

Article number	Bag / Box	Type	Subgroup
3-1403C*	10 pc. / 200 pc.	14x3/8"	
3-1404	10 pc. / 200 pc.	14x1/2"	
3-1604	10 pc. / 170 pc.	16x1/2"	
3-1804	10 pc. / 120 pc.	18x1/2"	
3-2004	10 pc. / 120 pc.	20x1/2"	
3-2005	10 pc. / 120 pc.	20x3/4"	
3-2605	5 pc. / 80 pc.	26x3/4"	
3-2606	5 pc. / 80 pc.	26x1"	
3-3206	5 pc. / 80 pc.	32x1"	

* FOR FUEL OIL



Type: 4



Elbow 90°
Knie 90°
Coude 90°
Winkel 90°

Article number	Bag / Box	Type	Subgroup
4-1414	10 pc. / 150 pc.	14x14	
4-1616	10 pc. / 110 pc.	16x16	
4-1818	10 pc. / 80 pc.	18x18	
4-2020	10 pc. / 60 pc.	20x20	
4-2626	10 pc. / 40 pc.	26x26	
4-3232	5 pc. / 32 pc.	32x32	

Type: 5



Bent 90° male adapter
Knie 90° buitendraad
Coude 90° mâle
Winkel 90° AG

Article number	Bag / Box	Type	Subgroup
5-1404	10 pc. / 150 pc.	14x1/2"	
5-1604	10 pc. / 150 pc.	16x1/2"	
5-1804	10 pc. / 100 pc.	18x1/2"	
5-1805 *	10 pc. / 100 pc.	18x3/4"	
5-2005	10 pc. / 100 pc.	20x3/4"	
5-2605	5 pc. / 40 pc.	26x3/4"	
5-2606	5 pc. / 40 pc.	26x1"	
5-3206	5 pc. / 40 pc.	32x1"	

* TILL EXHAUSTION OF STOCK

Type: 6



Bent 90° female adapter
Knie 90° binnendraad
Coude 90° femelle
Winkel 90° IG

Article number	Bag / Box	Type	Subgroup
6-1404	10 pc. / 150 pc.	14x1/2"	
6-1604	10 pc. / 150 pc.	16x1/2"	
6-1804	10 pc. / 90 pc.	18x1/2"	
6-1805	10 pc. / 80 pc.	18x3/4"	
6-2004	10 pc. / 80 pc.	20x1/2"	
6-2005	10 pc. / 80 pc.	20x3/4"	
6-2605	5 pc. / 50 pc.	26x3/4"	
6-2606	5 pc. / 30 pc.	26x1"	
6-3206	5 pc. / 40 pc.	32x1"	



Type: 7



Backplate elbow with branch connection
 Sanitair muurplaat binnendraad
 Culasse pour sanitaire femelle
 Sanitär Wandscheibe

Article number	Bag / Box	Type	Subgroup
7-1404	10 pc. / 80 pc.	14x1/2"	
7-1604	10 pc. / 80 pc.	16x1/2"	
7-1804	10 pc. / 60 pc.	18x1/2"	
7-2004	10 pc. / 60 pc.	20x1/2"	
7-2005	10 pc. / 40 pc.	20x3/4"	

- 1
- 2
- 3
- 4
- 5
- 6
- 7
- 8
- 9
- 10
- 11

Type: 7D



Double backplate elbow with branch connection
 Sanitair muurplaat binnendraad dubbel
 Culasse pour sanitaire femelle double
 Sanitär Wandscheibe doppelt

Article number	Bag / Box	Type	Subgroup
7-160416	10 pc. / 50 pc.	16x1/2"x16	

Type: H



Bracket for backplate elbow
 Tappuntbeugel
 Support pour culasse sanitaire
 Halteplatte

Article number	Bag / Box	Type	Subgroup
H716042005	10 pc. / 250 pc.	For: 7-1604, 7-1804, 7-2004	

Type: 8



T-piece
 T-stuk
 Piece en T
 T-Stück

Article number	Bag / Box	Type	Subgroup
8-141414	10 pc. / 100 pc.	14x14x14	
8-161616	10 pc. / 70 pc.	16x16x16	
8-181818	10 pc. / 50 pc.	18x18x18	
8-202020	10 pc. / 50 pc.	20x20x20	
8-262626	5 pc. / 30 pc.	26x26x26	
8-323232	5 pc. / 20 pc.	32x32x32	



Type: 9



T-female branch
T-binnendraad
Pièce en T femelle
T-IG

Article number	Bag / Box	Type	Subgroup
9-140414	10 pc. / 80 pc.	14x1/2"x14	
9-160416	10 pc. / 80 pc.	16x1/2"x16	
9-180418	10 pc. / 60 pc.	18x1/2"x18	
9-180518	10 pc. / 50 pc.	18x3/4"x18	
9-200420	10 pc. / 40 pc.	20x1/2"x20	
9-200520	10 pc. / 40 pc.	20x3/4"x20	
9-260526	5 pc. / 30 pc.	26x3/4"x26	
9-260626	5 pc. / 30 pc.	26x1"x26	
9-320632	5 pc. / 20 pc.	32x1"x32	

Type: 10



Nut, insert and jointing ring
Moer, Insert en klemring
Ecrou, insert et bicône
Mutter, Stutzhülse und Klemmring

Article number	Bag / Box	Type	Subgroup
10-161404SN	10 pc. / 300 pc.	14x1/2"	
10-1604SN	10 pc. / 300 pc.	16x1/2"	

Type: 11



T-male branch
T-buitendraad
Pièce en T mâle
T-AG

Article number	Bag / Box	Type	Subgroup
11-160416	10 pc. / 80 pc.	16x1/2"x16	
11-200420	10 pc. / 70 pc.	20x1/2"x20	
11-200520	10 pc. / 50 pc.	20x3/4"x20	
11-260526	5 pc. / 30 pc.	26x3/4"x26	
11-260626	5 pc. / 30 pc.	26x1"x26	
11-320632	5 pc. / 20 pc.	32x1"x32	



Type: 13



Nut, insert and jointing ring to copper compression
 Adapter Henco buis naar messing knelverbinding
 Raccord à visser cuivre vers multicouche
 Verbindungsstück Kupfer Schraub fitting auf Henco

Article number	Bag / Box	Type	Subgroup
13-1415 *	10 pc. / 200 pc.	14x15 Cu	
13-1615A *	10 pc. / 200 pc.	16x15 Cu	
13-1615HA	10 pc. / 200 pc.	16x15 Cu	
13-2022HA	10 pc. / 120 pc.	20x22 Cu	
13-2628H	10 pc. / 80 pc.	26x28 Cu	

* Nickel plated nut

Type: 13-VH



Adapter for Henco compression 26mm to copper compression 22mm
 Adapter Henco buis 26mm naar messing knelverbinding 22mm
 Adapteur raccord à visser cuivre 22mm vers multicouche 26mm
 Verbindungsstück für Henco Schraub fitting 26mm auf Kupfer Schraub fitting 22mm

Article number	Bag / Box	Type	Subgroup
13-V2622H	5 pc. / 75 pc.	26x22 Cu	

Type: 24



Compression coupling Henco x copper tube
 Overgangsstuk Henco knel x koperbuis knelverbinding
 Raccord droit Henco x tube de cuivre manchon à visser
 Gerade Fitting Henco x Klemmverbinder für Kupferrohr

Article number	Bag / Box	Type	Subgroup
24-1410	10 pc. / 200 pc.	14x10 Cu	
24-1615	10 pc. / 200 pc.	16x15 Cu	
24-2022	10 pc. / 100 pc.	20x22 Cu	
24-2622	5 pc. / 50 pc.	26x22 Cu	
24-2628	5 pc. / 50 pc.	26x28 Cu	

Type: 25



Cross T
 Kruis fitting
 Raccord croisé
 Kreuzungs fitting

Article number	Bag / Box	Type	Subgroup
25-14141414	5 pc. / 50 pc.	14x14x14x14	
25-16161616	5 pc. / 50 pc.	16x16x16x16	
25-18181818	5 pc. / 30 pc.	18x18x18x18	
25-20202020	5 pc. / 30 pc.	20x20x20x20	

- 1
- 2
- 3
- 4
- 5
- 6
- 7
- 8
- 9
- 10
- 11



Type: 28



T-reduced centre
T-verlopend
Pièce en T réduit
T-reduziert

Article number	Bag / Box	Type	Subgroup
28-181618	5 pc. / 50 pc.	18x16x18	
28-201616	5 pc. / 50 pc.	20x16x16	
28-201620	5 pc. / 50 pc.	20x16x20	
28-202016	5 pc. / 50 pc.	20x20x16	
28-261626	5 pc. / 30 pc.	26x16x26	
28-262026	5 pc. / 30 pc.	26x20x26	
28-322632	1 pc. / 20 pc.	32x26x32	

Type: EK



Nickel plated eurocone (3/4"F)
Euroconus schroefkoppeling (3/4"F)
Raccord à visser eurocone (3/4"F)
Schraubfitting Eurokonus (3/4"F)

Article number	Bag / Box	Type	Subgroup
EK12	10 pc. / 200 pc.	Ø12	
EK14	10 pc. / 200 pc.	Ø14	
EK16	10 pc. / 200 pc.	Ø16	
EK17	10 pc. / 200 pc.	Ø17	
EK18	10 pc. / 200 pc.	Ø18	
EK20	10 pc. / 200 pc.	Ø20	

Type: EKH



Brass eurocone (3/4"F)
Euroconus-schroefkoppeling (3/4"F) niet vernikkeld
Raccord à visser eurocone (3/4"F) laiton non nickelé
Schraubfitting Eurokonus (3/4"F) Messing nicht vernickelt

Article number	Bag / Box	Type	Subgroup
EK16	10 pc. / 200 pc.	Ø16	

Type: EK15



Eurocone (3/4"F) for copper tube 15mm
Euroconus-schroefkoppeling (3/4"F) voor koperbuis 15mm
Raccord à visser eurocone (3/4"F) pour tube de cuivre 15mm
Schraubfitting Eurokonus (3/4") für Kupferrohr 15mm

Article number	Bag / Box	Type	Subgroup
EK15	25 pc. / 400 pc.	Ø15	



Type: SPLIT OLIVE



Split olive for eurocone
Klemring voor EK
Anneau de serrage pour raccordement eurocone
Klemmring für EK

Article number	Tasche	Type	Subgroup
SPLIT12	10 pc.	Ø12	
SPLIT14	10 pc.	Ø14	
SPLIT16	10 pc.	Ø16	
SPLIT17	10 pc.	Ø17	
SPLIT18	10 pc.	Ø18	
SPLIT20	10 pc.	Ø20	

- 1
- 2
- 3
- 4
- 5
- 6
- 7
- 8
- 9
- 10
- 11

Type: SPLIT-S



Split ring for compression fittings (not for EK)
Klemring voor schroef fittingen (niet voor EK)
Anneau de serrage pour raccords à visser (pas pour EK)
Klemring für Schraub fitting (nicht für EK)

Article number	Tasche	Type	Subgroup
SPLIT-S16	10 pc.	Ø16	
SPLIT-S20	10 pc.	Ø20	

Type: AB



Bent 90° eurocone elbow (3/4" M)
Knie 90° voor euroconus-aansluiting (3/4" M)
Coude 90° pour raccordement eurocone (3/4" M)
Winkel 90° für Eurokonusanschluß (3/4" M)

Article number	Bag / Box	Type	Subgroup
AB1420	10 pc. / 100 pc.	3/4"x3/4" for EK	

Type: ABE



Bent 90° eurocone (3/4" M) x 1/2" male adapter
Knie 90° buitendraad 1/2 x euroconus-aansluiting (3/4" M)
Coude 90° mâle 1/2" x raccordement eurocone (3/4" M)
Winkel 90° AG 1/2 x Eurokonusanschluss (3/4" M)

Article number	Bag / Box	Type	Subgroup
ABEK04	10 pc. / 150 pc.	1/2"x3/4" - 1/2"	



- 1
- 2
- 3
- 4
- 5
- 6
- 7
- 8
- 9
- 10
- 11

Type: AT



Eurocone equal T
 T voor euroconus-aansluiting (3/4" M)
 Pièce en T pour raccordement eurocone (3/4" M)
 T für Eurokonusanschluß (3/4" M)

Article number	Bag / Box	Type	Subgroup
AT1420	10 pc. / 100 pc.	3/4"x3/4"x3/4"	

Type: AD



Eurocone straight coupling (3/4" M)
 Euroconus nippel (3/4" M)
 Mamelon 2x raccordement eurocone (3/4" M)
 Nippel für 2x Eurokonusanschluss

Article number	Bag / Box	Type	Subgroup
AD-EK	10 pc. / 250 pc.	3/4"x3/4" for EK	

Type: AN



Straight eurocone connection (3/4" M) to 1/2" male adapter
 Recht overgangsstuk 1/2" M met O-ring en EK-aansluiting (3/4" M)
 Manchon droit mâle 1/2" avec o-ring et eurocone
 Nippel AG 1/2" mit O-ring und Eurokonusanschluss (3/4" M)

Article number	Bag / Box	Type	Subgroup
AN1420	10 pc. / 250 pc.	1/2"x3/4" for EK	

Type: 3EK



Double backplate elbow female, 2x eurocone connection
 Doorstroom muurplaat binnendraad, 2x euroconus-aansluiting
 Culasse double, 2x raccordement eurocone
 Wandscheibe doppelt IG, 2x Eurokokusanschluss

Article number	Bag / Box	Type	Subgroup
3EK-050405	5 pc. / 40 pc.	3/4"x1/2"x3/4" (50 mm)	



Type: ID



Single plastic box without eurocone-fitting
 Inbouwdoosje sanitair enkel zonder euroconus-fitting
 Boîtier sanitaire simple sans raccord eurocone
 kunststoffeinbau Wandwinkel einfach ohne EK-Verschraubung

Article number	Bag / Box	Type	Subgroup
ID-EK	10 pc. / 20 pc.	1/2" Fx3/4" for EK	

- 1
- 2
- 3
- 4
- 5**
- 6
- 7
- 8
- 9
- 10
- 11

Type: ID2



Double plastic backplate box without eurocone fitting
 Inbouwdoosje sanitair dubbel zonder euroconus-fitting
 Boîtier sanitaire double sans raccord eurocone
 kunststoffeinbau Wandwinkel doppelt ohne EK-Verschraubung

Article number	Bag / Box	Type	Subgroup
ID2-EK	10 pc. / 10 pc.	1/2" Fx3/4"x3/4"	





Type: V-06

- 1
- 2
- 3
- 4
- 5
- 6
- 7
- 8
- 9
- 10
- 11

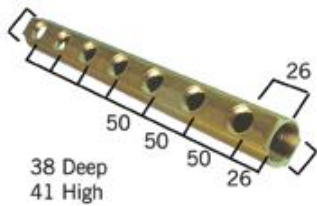

Manifold 1", 1/2" female thread, 3/8" air vent hole
 Verdeler 1", 1/2" aansluitingen, 3/8" ontluuchtingsopening
 Collecteur 1", conn. 1/2" femelle, conn. 3/8" pour purgeur
 Verteiler 1", 1/2" IG, 3/8" Loch für Entlüftung

Article number	pc/ Box	Type	Subgroup
V-060402	1 pc. / 64 pc.	1" 2x1/2" x 3/8"	
V-060403	1 pc. / 48 pc.	1" 3x1/2" x 3/8"	
V-060404	1 pc. / 30 pc.	1" 4x1/2" x 3/8"	
V-060405	1 pc. / 28 pc.	1" 5x1/2" x 3/8"	
V-060406	1 pc. / 20 pc.	1" 6x1/2" x 3/8"	
V-060407	1 pc. / 25 pc.	1" 7x1/2" x 3/8"	
V-060408	1 pc. / 20 pc.	1" 8x1/2" x 3/8"	
V-060409	1 pc. / 20 pc.	1" 9x1/2" x 3/8"	
V-060410	1 pc. / 20 pc.	1" 10x1/2" x 3/8"	

Type: V-05-Z



Manifold 3/4", 1/2" female thread
 Verdeler 3/4", 1/2" aansluitingen
 Collecteur 3/4", conn. 1/2" femelle
 Verteiler 3/4", 1/2" IG

Article number	pc/ Box	Type	Subgroup
V-050402-Z	1 pc. / 75 pc.	3/4" 2x1/2"	
V-050403-Z	1 pc. / 48 pc.	3/4" 3x1/2"	
V-050404-Z	1 pc. / 30 pc.	3/4" 4x1/2"	
V-050405-Z	1 pc. / 42 pc.	3/4" 5x1/2"	
V-050406-Z	1 pc. / 20 pc.	3/4" 6x1/2"	
V-050407-Z	1 pc. / 18 pc.	3/4" 7x1/2"	
V-050408-Z	1 pc. / 25 pc.	3/4" 8x1/2"	
V-050409-Z*	1 pc. / 20 pc.	3/4" 9x1/2"	
V-050410-Z	1 pc. / 20 pc.	3/4" 10x1/2"	

* TILL EXHAUSTION OF STOCK

Type: V-06-Z

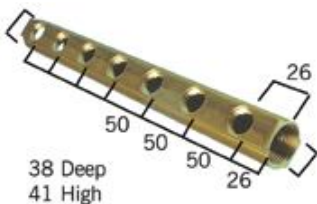

Manifold 1", 1/2" female thread
 Verdeler 1", 1/2" aansluitingen
 Collecteur 1", conn. 1/2" femelle
 Verteiler 1", 1/2" IG

Article number	pc/ Box	Type	Subgroup
V-060402-Z	1 pc. / 64 pc.	1" 2x1/2"	
V-060403-Z	1 pc. / 48 pc.	1" 3x1/2"	
V-060404-Z	1 pc. / 30 pc.	1" 4x1/2"	
V-060405-Z	1 pc. / 28 pc.	1" 5x1/2"	
V-060406-Z	1 pc. / 20 pc.	1" 6x1/2"	
V-060407-Z	1 pc. / 25 pc.	1" 7x1/2"	
V-060408-Z	1 pc. / 20 pc.	1" 8x1/2"	
V-060409-Z	1 pc. / 20 pc.	1" 9x1/2"	
V-060410-Z	1 pc. / 20 pc.	1" 10x1/2"	



Type: V-07-Z

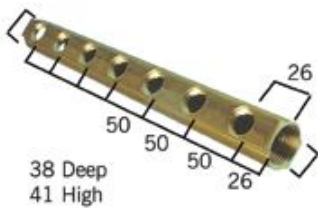

Manifold 5/4", 1/2" female thread
 Verdeler 5/4", 1/2" aansluitingen
 Collecteur 5/4", conn. 1/2" femelle
 Verteiler 5/4", 1/2" IG

Article number	pc / Box	Type	Subgroup
V-070402-Z	1 pc. / 40 pc.	5/4" 2x1/2"	
V-070403-Z	1 pc. / 32 pc.	5/4" 3x1/2"	
V-070404-Z	1 pc. / 20 pc.	5/4" 4x1/2"	
V-070405-Z	1 pc. / 14 pc.	5/4" 5x1/2"	
V-070406-Z	1 pc. / 15 pc.	5/4" 6x1/2"	
V-070407-Z	1 pc. / 20 pc.	5/4" 7x1/2"	
V-070408-Z	1 pc. / 20 pc.	5/4" 8x1/2"	
V-070409-Z*	1 pc. / 10 pc.	5/4" 9x1/2"	
V-070410-Z	1 pc. / 10 pc.	5/4" 10x1/2"	

* TILL EXHAUSTION OF STOCK

Type: VEK-06



Manifold 1" with EK connections and one 3/8" air vent hole
 Verdeler 1" met EK-aansluitingen en 3/8" ontluichtingsopening
 Collecteur 1" avec des raccords eurocone et un trou 3/8" pour purgeur
 Verteiler 1" mit EK-Anschlüssen und 3/8" Loch für Entlüftung

Article number	pc / Box	Type	Subgroup
VEK-060502	1 pc. / 48 pc.	1" 2x3/4" x 3/8"	
VEK-060503	1 pc. / 32 pc.	1" 3x3/4" x 3/8"	
VEK-060504	1 pc. / 20 pc.	1" 4x3/4" x 3/8"	
VEK-060505	1 pc. / 21 pc.	1" 5x3/4" x 3/8"	
VEK-060506	1 pc. / 20 pc.	1" 6x3/4" x 3/8"	
VEK-060507	1 pc. / 20 pc.	1" 7x3/4" x 3/8"	
VEK-060508	1 pc. / 20 pc.	1" 8x3/4" x 3/8"	
VEK-060509	1 pc. / 15 pc.	1" 9x3/4" x 3/8"	
VEK-060510	1 pc. / 15 pc.	1" 10x3/4" x 3/8"	

Type: VEK-06-Z

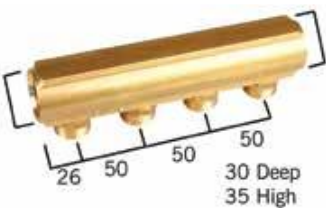

Manifolds 1" with eurocone connections
 Verdeler 1" met euroconus-aansluitingen
 Collecteur 1" avec des raccords eurocone
 Verteiler 1" mit Eurokonus-Anschlüssen

Article number	pc / Box	Type	Subgroup
VEK-060502-Z	1 pc. / 48 pc.	1" 2x3/4"EK	
VEK-060503-Z	1 pc. / 32 pc.	1" 3x3/4"EK	
VEK-060504-Z	1 pc. / 20 pc.	1" 4x3/4"EK	
VEK-060505-Z	1 pc. / 21 pc.	1" 5x3/4"EK	
VEK-060506-Z	1 pc. / 20 pc.	1" 6x3/4"EK	
VEK-060507-Z	1 pc. / 20 pc.	1" 7x3/4"EK	
VEK-060508-Z	1 pc. / 20 pc.	1" 8x3/4"EK	
VEK-060509-Z	1 pc. / 15 pc.	1" 9x3/4"EK	
VEK-060510-Z	1 pc. / 15 pc.	1" 10x3/4"EK	



Type: VEK-05-Z

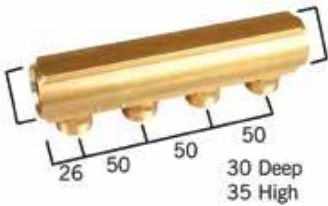

Manifold 3/4" with eurocone connections
 Verdeler 3/4" met euroconus-aansluitingen
 Collecteur 3/4" avec des raccordements eurocone
 Verteiler 3/4" mit Eurokonus-Anschlüssen

Article number	pc / Box	Type	Subgroup
VEK-050502-Z	8 pc. / 64 pc.	3/4" 2x3/4"	
VEK-050503-Z	6 pc. / 48 pc.	3/4" 3x3/4"	
VEK-050504-Z	6 pc. / 30 pc.	3/4" 4x3/4"	
VEK-050505-Z	4 pc. / 28 pc.	3/4" 5x3/4"	
VEK-050506-Z	4 pc. / 20 pc.	3/4" 6x3/4"	
VEK-050507-Z	1 pc. / 25 pc.	3/4" 7x3/4"	
VEK-050508-Z	1 pc. / 25 pc.	3/4" 8x3/4"	
VEK-050509-Z	1 pc. / 20 pc.	3/4" 9x3/4"	
VEK-050510-Z	1 pc. / 20 pc.	3/4" 10x3/4"	

TILL EXHAUSTION OF STOCK

Type: VEK-05-ZV



Manifold 3/4" with eurocone connections
 Verdeler 3/4" met euroconus-aansluitingen
 Collecteur 3/4" avec des raccordements eurocone
 Verteiler 3/4" mit Eurokonus-Anschlüssen

Article number	pc / Box	Type	Subgroup
VEK-050502-ZV	1 pc. / 8 pc.	3/4" 2x3/4"	
VEK-050503-ZV	1 pc. / 8 pc.	3/4" 3x3/4"	

Type: VEK-06-ZV



Manifold 1" with eurocone connections
 Verdeler 1" met euroconus-aansluitingen
 Collecteur 1" avec des raccordements eurocone
 Verteiler 1" mit Eurokonus-Anschlüssen

Article number	pc / Box	Type	Subgroup
VEK-060502-ZV	1 pc. / 8 pc.	1" 2x3/4"	

TILL EXHAUSTION OF STOCK

Type: H-0212



Insulated manifold bracket (pairs)
 Ophangbeugel dubbel met isolatie voor alle verdelers
 Support double avec isolation pour tous les collecteurs
 Verteiler-Halter mit Isolierung doppelt für alle Verteiler

Article number	pc / Box	Type	Subgroup
H-0212	1 pc. / 150 pc.	3/4" - 1" - 5/4"	



Type: H-0212-S



Insulated manifold bracket (single)
Ophangbeugel enkel met isolatie voor alle verdelers
Support simple avec isolation pour tous les collecteurs
Verteiler-Halter mit Isolierung einfach für alle Verteiler

Article number	pc / Box	Type	Subgroup
H-0212-S	1 pc. / 500 pc.	3/4" - 1" - 5/4"	

Type: VS REDUCTIE



Manifold reducer with O-ring
Reductie met O-ring voor verdeler
Réduction avec O-ring pour collecteur
Reduktion für Verteiler mit O-ring

Article number	pc / Box	Type	Subgroup
VS-0504	10 pc. / 500 pc.	3/4"x1/2"	
VS-0604	10 pc. / 250 pc.	1"x1/2"	
VS-0605	10 pc. / 250 pc.	1"x3/4"	
VS-0706	10 pc. / 200 pc.	5/4"x1"	

Type: VS BLINDSTOP



Manifold plug with O-ring
Blindstop met O-ring voor verdeler
Bouchon avec O-ring pour collecteur
Stopfen mit O-Ring für Verteiler

Article number	pc / Box	Type	Subgroup
VS-05	10 pc. / 250 pc.	3/4"	
VS-06	10 pc. / 200 pc.	1"	
VS-07	10 pc. / 200 pc.	5/4"	

Type: VB-EK05



Ball valve, 2 x eurocone connection
Bolkraan , 2 x euroconus aansluiting
Vanne d'arrêt, 2 x raccordement eurocone
Kugelhahn, 2 x Eurokonus

Article number	Box / Big Box	Type	Subgroup
VB-EK05	25 pc. / 200 pc.	3/4" EKx3/4" EK	

Type: VR-EK05



Lockshield 2x eurocone connection
Regelkraan 2x euroconus aansluiting
Te de reglage 2x raccordement eurocone
Asperrbare Ventil 2x eurokonus

Article number	Type	Subgroup
• VR-EK05	3/4" EKx3/4" EK	

Type: VB05



Manifold 3/4" with ball valves and eurocone connection
Verdeler 3/4" met bolkraan en euroconus-aansluiting
Collecteur 3/4" avec vanne d'arrêt et eurocone
Verteiler 3/4" mit Kugelhahnset und Eurokonus

Article number	pc / Box	Type	Subgroup
VB050502-BLAUW	5 pc. / 50 pc.	3/4"x2xEK14,16,18 & 20	
VB050502-ROOD	5 pc. / 50 pc.	3/4"x2xEK14,16,18 & 20	
VB050503-BLAUW	5 pc. / 50 pc.	3/4"x3xEK14,16,18 & 20	
VB050503-ROOD	5 pc. / 50 pc.	3/4"x3xEK14,16,18 & 20	
VB050504-BLAUW	4 pc. / 40 pc.	3/4"x4xEK14,16,18 & 20	
VB050504-ROOD	4 pc. / 40 pc.	3/4"x4xEK14,16,18 & 20	

Type: VB06



Manifold 1" with ball valves and eurocone connection
Verdeler 1" met bolkraan en euroconus-aansluiting
Collecteur 1" avec vanne d'arrêt et eurocone
Verteiler 1" mit Kugelhahnset und Eurokonus

Article number	pc / Box	Type	Subgroup
VB060502-BLAUW	5 pc. / 50 pc.	1"x2xEK14,16,18 & 20	
VB060502-ROOD	5 pc. / 50 pc.	1"x2xEK14,16,18 & 20	
VB060503-BLAUW	5 pc. / 40 pc.	1"x3xEK14,16,18 & 20	
VB060503-ROOD	5 pc. / 40 pc.	1"x3xEK14,16,18 & 20	
VB060504-BLAUW	4 pc. / 40 pc.	1"x4xEK14,16,18 & 20	
VB060504-ROOD	4 pc. / 40 pc.	1"x4xEK14,16,18 & 20	





Type: RAD04-100V



Radiator connector with 3/4" eurocone connections, straight
 Onderblok met 3/4" euroconus-aansluitingen, recht
 Raccord radiateur, droit, eurocone
 Heizkörperanschluss 1/2" mit 3/4" Eurokonus-Anschlüssen, unten

Article number	Box / Big Box	Type	Subgroup
RAD04-100V	10 pc. / 100 pc.	1/2"x3/4"EK	

- 1
- 2
- 3
- 4
- 5
- 6
- 7
- 8
- 9
- 10
- 11

Type: RAD04-100H



Radiator connector with 3/4" eurocone connections, bent
 Onderblok met 3/4" euroconus-aansluitingen, haaks
 Raccord radiateur, équerre, eurocone
 Heizkörperanschluss 1/2" mit 3/4" Eurokonus-Anschlüssen, hinten

Article number	Box / Big Box	Type	Subgroup
RAD04-100H	10 pc. / 100 pc.	1/2"x3/4"EK	

TILL EXHAUSTION OF STOCK

Type: EK15



Eurocone (3/4" F) for copper tube 15mm
 Euroconus-schroefkoppeling (3/4" F) voor koperbuis 15mm
 Raccord à visser eurocone (3/4" F) pour tube en cuivre 15mm
 Schraub fitting Eurokonus (3/4") für Kupferrohr 15mm

Article number	Box / Big Box	Type	Subgroup
EK15	25 pc. / 400 pc.	Ø15	

Type: RADK2-R



Radiator valve 1/2" with 3/4" eurocone connection, straight
 Radiatorkraan 1/2" met 3/4" euroconus-aansluiting, recht
 Vanne radiateur droite 1/2" avec raccordement EK
 Heizkörperventil 1/2" mit 3/4" Eurokonus-Anschluss, gerade

Article number	Box / Big Box	Type	Subgroup
RADK2-R	10 pc. / 100 pc.	1/2"x3/4"EK	



- 1
- 2
- 3
- 4
- 5
- 6
- 7
- 8
- 9
- 10
- 11

Type: RADTH-VL



Thermostatic radiator valve head
 Thermostatisch regulelement met vaste vloeistofvoeler
 Tête thermostatique à bulbe, équipée d'un réglage de température limite
 Thermostatkopf mit festem Flüssigkeitsfühler

Article number	Box / Big Box	Type	Subgroup
RADTH-VL	10 pc. / 150 pc.	THERM	

TILL EXHAUSTION OF STOCK

Type: RADV-2-R



2-way lockshield valve 1/2", straight x 3/4" eurocone
 Voetventiel 1/2" 2-weg recht x 3/4" euroconus
 Raccord droit réglable, 1/2" x eurocone
 Absperrbare Rücklaufverschraubung Durchgang x 3/4" Eurokonus

Article number	Box / Big Box	Type	Subgroup
RADV-2-R	10 pc. / 100 pc.	1/2"x3/4"EK	

Type: RADH4-100V



Straight radiator H-block with valve, supplied without nipple x 3/4" eurocone
 Radiator H-blok met afsluiter, recht, geleverd zonder nippel x 3/4" euroconus
 Raccord robinet vertical, eurocone, livré sans nippel
 Heizkörperanschlussgarnitur mit 3/4" Eurokonus-Anschlüssen, unten

Article number	Bag / Box	Type	Subgroup
RADH4-100V	1 pc. / 50 pc.	3/4"x3/4"EK	

Type: RADH4-100H



Bent radiator H-block with valve, supplied without nipple x 3/4" eurocone
 Radiator H-blok met afsluiter, haaks, geleverd zonder nippel x 3/4" euroconus
 Raccord robinet horizontal, eurocone, livré sans nipples
 Heizkörperanschlussgarnitur mit 3/4" Eurokonus-Anschlüssen, hinten

Article number	Bag / Box	Type	Subgroup
RADH4-100H	1 pc. / 50 pc.	3/4"x3/4"EK	



Type: RADNI



Nipple for H radiator block
 Nippel voor H-radiatorblok
 Vanne pour raccord radiateur (H&V)
 Nippel für H-Anschluss

Article number	Bag / Box	Type	Subgroup
RADNI-0504	10 pc. / 500 pc.	1/2"x3/4"	

Type: RAD-H



Micromatic wheelhandle for thermostatic valve
 Micromatisch handvat voor thermostatische kraan
 Capuchon micromatique pour vanne thermostatique
 Handgriff für Thermostatventil

Article number	Box	Type	Subgroup
RAD-H	50 pc.	HANDLE	

TILL EXHAUSTION OF STOCK

Type: RAD-B



Elbow 1/2"
 Kniekoppeling 1/2"
 Coude 1/2"
 Winkel 1/2"

Article number	Box / Big Box	Type	Subgroup
RAD-B	25 pc. / 275 pc.	1/2"x3/4"	

TILL EXHAUSTION OF STOCK

Type: BAP-H



Ball valve with handle, 2 x press fitting
 Kogelkraan met handvat, 2 x perskoppeling
 Vanne à bille
 Kugelhahnset mit Handgriff, 2 x Press fitting

Article number	Box / Big Box	Type	Subgroup
BAP-H1616	10 pc. / 100 pc.	16x16	
BAP-H2020	10 pc. / 100 pc.	20x20	
BAP-H2626	10 pc. / 100 pc.	26x26	
BAP-H3232	10 pc. / 100 pc.	32x32	

- 1
- 2
- 3
- 4
- 5
- 6
- 7
- 8
- 9
- 10
- 11

- 1
- 2
- 3
- 4
- 5
- 6
- 7
- 8
- 9
- 10
- 11

Type: BAP-SK



Ball valve with handle, 2 x push fitting
 Kogelkraan met handvat, 2 x steek fitting
 Vanne à bille
 Kugelhahnset mit Handgriff, 2 x Push fitting

Article number	Box / Big Box	Type	Subgroup
BAP-SK1616	6 pc. / 60 pc.	16x16	
BAP-SK2020	6 pc. / 30 pc.	20x20	
BAP-SK2626	6 pc. / 30 pc.	26x26	

Type: BAP-SV



Stopvalve DN10
 Stopbolkraan DN10
 Vanne d'arrêt DN10
 Stopvalve DN10

Article number	Box / Big Box	Type	Subgroup
BAP-SV1610S	10 pc. / 100 pc.	16 x 10	

Type: BA-CC



Built-in ball valve with chromed cap 2x3/4" eurocone
 Inbouwbolkraan met verchromde dop 2x3/4" EK
 Vanne d'arrêt avec bouchon chrome 2x eurocone
 Einbau Kugelhahnset mit Kappe verchromt 2x3/4" EK

Article number	Box / Big Box	Type	Subgroup
BA-CC	5 pc. / 50 pc.	3/4"EKx3/4"EK	

TILL EXHAUSTION OF STOCK

Type: BA-CH



Built in ball valve with chromed lever handle 2x3/4" eurocone
 Inbouwbolkraan met verchromde hefboomhandvat 2x3/4" EK
 Vanne d'arrêt avec manche levier chrome 2x eurocone
 Einbau Kugelhahnset mit Hebelhandgriff verchromt 2x3/4" EK

Article number	Box / Big Box	Type	Subgroup
BA-CH	5 pc. / 50 pc.	3/4"EKx3/4"EK	

TILL EXHAUSTION OF STOCK



Type: BA-CS



Built in eurocone ball valve 2x3/4" eurocone with chromed handle
 Inbouwbolkraan 2x3/4" EK met verchromd handvat
 Vanne d'arrêt 2x eurocone avec manche chrome
 Einbau Kugelhahnset 2x3/4" EK mit Handgriff verchromt

Article number	Box / Big Box	Type	Subgroup
BA-CS	6 pc. / 60 pc.	3/4"EKx3/4"EK	

TILL EXHAUSTION OF STOCK

Type: VALVE-SET7



Radiator connector 3/4" eurocone connection bent + radiator valve 1/2" with 3/4" eurocone connection bent + 2x adapter for connecting tube 15mm
 Onderblok met 3/4" euroconus-aansluitingen, haaks + radiatorkraan 1/2" met 3/4" euroconus aansluiting, haaks + 2x adapter voor verbindingsbuis 15mm
 Set raccordement radiateur eurocone, équerre + vanne radiateur 1/2" avec raccordement 3/4" EK, équerre + 2x tube de connection 15mm
 Heizkörperanschluss mit 3/4" Eurokonus-Anschlüssen, rechtwinklig + Heizkörperventil 1/2" mit 3/4" Eurokonus Anschluss, rechtwinklig + 2x Adapter für Verbindungsrohr 15mm

Article number	Box	Type	Subgroup
VALVE-SET7	1 set		

Type: VALVE-SET3



Radiator connector 3/4" eurocone connection bent + thermostatic radiator valve straight body 1/2" male connection + 2x connecting tube 15 mm + bent 1/2"
 Onderblok met 3/4" euroconus-aansluitingen, haaks + thermostatischeerbare radiatorkraan 1/2", voorinstelbaar en recht + 2x adapter voor verbindingsbuis 15mm + bochtkoppeling 1/2"
 Set raccordement radiateur eurocone, équerre + vanne thermostatisable 1/2", droit + 2x tube de connection 15mm + coude 1/2"
 Heizkörperanschluss mit 3/4" EK-Anschlüssen, rechtwinklig + voreinstellbarer Heizkörperventil 1/2" in Durchgang + 2x Adapter für Verbindungsrohr 15 mm + Winkel 1/2"

Article number	Box	Type	Subgroup
VALVE-SET3	1 set		

- 1
- 2
- 3
- 4
- 5
- 6
- 7
- 8
- 9
- 10
- 11



Type: VALVE-SET14



Radiator connector 50% 3/4" EK connection bent + thermostatic radiator valve straight body 1/2" male connection + 2x connecting tube 15 mm + 3/4" EK
Onderblok 50% met 3/4" EK-aansluitingen, recht + thermostatische radiatorkraan 1/2", voorinstelbaar en haaks verkeer + 2x adapter voor verbindingbuis 15mm x 3/4" EK
Set raccordement radiateur eurocone, droit + vanne thermostatisable 1/2", équerre inversée+ 2x tube de connection 15mm + 3/4" EK
Heizkörperanschluss 50% mit 3/4" EK-Anschlüssen, gerade + vorinstellbarer Heizkörperhahn 1/2" in Durchgang + 2x Adapter für Verbindungsrohr 15 mm + Winkel 1/2"

Article number	Box	Type	Subgroup
VALVE-SET14	1 set		

UNDERFLOOR HEATING - VLOERVERWARMING - CHAUFFAGE PAR LE SOL - FUSSBODENHEIZUNG



	Page
A. SYSTEMS	108
B. MANIFOLDS	121
C. CONTROL UNITS	133
D. GEOTHERMAL	147

Type: UFH-ISOPRO30



System plate with 30 mm EPS insulation and 28dB acoustic improvement
 Noppenplaat met 30 mm EPS isolatie, 28 dB geluidsverbetering
 Plaque à plot avec isolation EPS de 30 mm, isolant acoustique 28dB
 Systemplatte mit Dämmung Styropor 30 mm, Trittschallverbesserung 28dB

Article number	Packing	Type	Subgroup
UFH-ISOPRO30 *	6,72m ² (6 x 1,12m ²)	1400x800mm - 5kPa - 28dB	

* Pipe Ø16, centre-to-centre: multiple 50mm hor./ver.

Type: UFH-ISOPRO11



System plate with 11 mm EPS insulation
 Noppenplaat met 11 mm EPS isolatie
 Plaque à plot avec isolation EPS de 11 mm
 Systemplatte mit Dämmung Styropor 11 mm

Article number	Packing	Type	Subgroup
UFH-ISOPRO11 *	14,56m ² (13 x 1,12m ²)	1400x800mm - 75kPa	

* Pipe Ø16, centre-to-centre: multiple 50mm hor./ver.

Type: UFH-PRO



System plate without insulation
 Noppenplaat zonder isolatie
 Plaque à plot sans isolation
 Systemplatte ohne Dämmung

Article number	Packing	Type	Subgroup
UFH-PRO *	13,44m ² (12 x 1,12m ²)	1400x800mm - 5kPa	

* Pipe Ø16, centre-to-centre: multiple 50mm hor./ver.

Type: UFH-ISO



EPS insulation board
 Vlakke EPS isolatieplaat
 Isolation EPS lisse
 Dämmung aus Styropor

Article number	Packing	Type	Subgroup
UFH-ISO-20	15 m ²	1000 x 500 x 20 mm	
UFH-ISO-30	10 m ²	1000 x 500 x 30 mm	

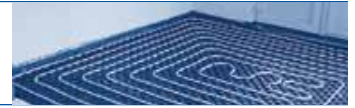

Type: UFH-PRO-DIA



Diagonal holder for system plate
 Diagonaalhouder voor noppenplaat
 Fixation diagonale en □m PS
 Diagonalfestigung aus PS

Article number	Packing	Type	Subgroup
UFH-PRO-DIA*	40 pc.	50 mm	

* Centre-to-centre distance diagonal: multiple 70mm

- 1
- 2
- 3
- 4
- 5
- 6
- 7
- 8
- 9
- 10
- 11

Type: UFH-ISOPRO-AD30



Insulation plate for transition piece, 30 mm
 Isolatieplaat voor overgangsstuk, 30 mm
 Pièce de jonction en isolation EPS de 30 mm
 Anschlussstück aus Styropordämmung 30 mm

Article number	Packing	Type	Subgroup
UFH-ISOPRO-AD30	1 pc.	1000x200x30mm	

Type: UFH-ISOPRO-AD11



Insulation plate for transition piece, 11 mm
 Isolatieplaat voor overgangsstuk, 11 mm
 Pièce de jonction en isolation EPS de 11 mm
 Anschlussstück aus Styropordämmung 11 mm

Article number	Packing	Type	Subgroup
UFH-ISOPRO-AD11	1 pc.	1000x200x11mm	

Type: UFH-PRO-ADA



Transition piece without insulation for system plate
 Overgangsstuk zonder isolatie voor noppenplaat
 Pièce de jonction en □m PS sans isolation
 Anschlussstück aus PS ohne Dämmung

Article number	Packing	Type	Subgroup
UFH-PRO-ADA	1 pc.	1450x210mm	

Type: UFH-PRO-IND



System plate without insulation, industrial application
 Noppenplaat zonder isolatie, voor industriële toepassing
 Plaque à plot sans isolation, application industrielle
 Systemplatte ohne Dämmung, Industrieanwendungen

Article number	Packing	Type	Subgroup
UFH-PRO-IND*	19,44m ² (18 x 1,08m ²)	1275x975mm	

* Pipe Ø16-20, centre-to-centre distance: multiple 75mm hor./ver.

Type: UFH-PRO-IND-B



Plate for bends, industrial application
 Bochtplaat voor industriële noppenplaat
 Plaque de courbe, application industrielle
 Platte für Bogen, Industrieanwendungen

Article number	Packing	Type	Subgroup
UFH-PRO-IND-B	1 pc.	1200x575mm	

Type: UFH-RAS10



Galvanized steel mesh, 100 x 100 mm, 3 mm
 Stalen draadmat verzinkt, 100 x 100 mm, 3 mm
 Treillis en acier galvanisé, trame de 100 x 100 mm, 3 mm
 Trägermatte aus Eisen verzinkt, Masche 100 x 100 mm, 3 mm

Article number	Packing	Type	Subgroup
UFH-RAS10	10 pc.	2,52m ² - grid 100x100mm	

Type: UFH-RAS15



Galvanized steel mesh, 150 x 150 mm, 3 mm
 Stalen draadmat verzinkt, 150 x 150 mm, 3 mm
 Treillis en acier galvanisé, trame de 150 x 150 mm, 3 mm
 Trägermatte aus Eisen verzinkt, Masche 150 x 150 mm, 3 mm

Article number	Packing	Type	Subgroup
UFH-RAS15	10 pc.	2,52m ² - grid 150x150mm	

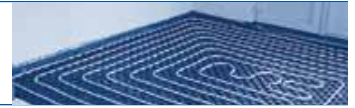

Type: UFH-RAS20



Galvanized steel mesh, 200 x 200 mm, 3 mm
 Stalen draadmat verzinkt, 200 x 200 mm, 3 mm
 Treillis en acier galvanisé, trame de 200 x 200 mm, 3 mm
 Trägermatte aus Eisen verzinkt, Masche 200 x 200 mm, 3 mm

Article number	Packing	Type	Subgroup
• UFH-RAS20	10 pc.	2,88m ² - grid 200x200mm	

- 1
- 2
- 3
- 4
- 5
- 6
- 7
- 8
- 9
- 10
- 11

Type: UFH-RAS25



Galvanized steel mesh, 250 x 250 mm, 3 mm
 Stalen draadmat verzinkt, 250 x 250 mm, 3 mm
 Treillis en acier galvanisé, trame de 250 x 250 mm, 3 mm
 Trägermatte aus Eisen verzinkt, Masche 250 x 250 mm, 3 mm

Article number	Packing	Type	Subgroup
• UFH-RAS25	10 pc.	2,77m ² - grid 250x250mm	

Type: UFH-RAS-RB3



Connection clip for steel mesh
 Verbindingsclip voor stalen draadmatten
 Clip de fixation pour treillis
 Verbinder für Trägermatte

Article number	Packing	Type	Subgroup
UFH-RAS-RB3	30 pc.	FB	

Type: UFH-RAS-BIND15



Steel strand, plasticized, to connect pipe on steel mesh
 Stalen vlechtdraad, geplasticeerd, om buis op draadmat te binden
 Fil de tressage métallique, plastié, pour fixer tube sur treillis
 Stahldraht, plastiiziert, für Befestigung der Rohre auf Trägermatte

Article number	Packing	Type	Subgroup
UFH-RAS-BIND15A	250 pc.	160 mm	
UFH-RAS-BIND15B	2500 pc.	160 mm	

Type: UFH-RAS-CLIP



Synthetic clip for steel mesh
Kunststofclip voor draadmat
Attache en plastique pour treillis
Rohrclip für Trägermatte

Article number	Packing	Type	Subgroup
UFH-RAS-CLIP16	200 pc.	Ø16	
UFH-RAS-CLIP18	200 pc.	Ø18	
UFH-RAS-CLIP20	200 pc.	Ø20	

Type: UFH-TACK-KLS



Tacker sheet with EPS insulation, foil with 100 x 100 mm grid marking and overlap, acoustic improvement

Tacker klapset met EPS isolatie voorzien van folie met raster 100 x 100 mm en overlap, geluidsverbetering

Plaque tacker en isolation EPS, □Im avec trame 100 x 100 mm et rabat, isolant acoustique

Verbundplatte aus Styropordämmung mit Folie Masche 100 x 100 mm und Überschneidung, Trittschallverbesserung

Article number	Packing	Type	Subgroup
UFH-TACK-KLS15	10 m ² (5 x 2 m ²)	1000x2000x15mm - 4kPa - 17dB	
UFH-TACK-KLS20	10 m ² (5 x 2 m ²)	1000x2000x20mm - 4kPa - 33dB	
UFH-TACK-KLS25	10 m ² (5 x 2 m ²)	1000x2000x25mm - 4kPa - 33dB	
UFH-TACK-KLS30	10 m ² (5 x 2 m ²)	1000x2000x30mm - 4kPa - 33dB	
UFH-TACK-KLS35	10 m ² (5 x 2 m ²)	1000x2000x35mm - 4kPa - 33dB	

Type: UFH-TACK-ROL



Tacker roll with EPS insulation, foil with marking 100 x 100 mm and overlap, 33 dB acoustic improvement

Tacker rol met EPS isolatie voorzien van folie met raster 100 x 100 mm en overlap, 33dB geluidsverbetering

Rouleau tacker en isolation EPS, □Im plastique avec trame 100 x 100 mm et rabat, isolant acoustique de 33dB

Roll-Dämmung aus Styropor mit Folie 100 x 100 mm und Überschneidung, Trittschallverbesserung 33dB

Article number	Packing	Type	Subgroup
UFH-TACK-ROL20	10 m ² (1 x 10 m ²)	1000x10.000x20mm - 4kPa - 33dB	
UFH-TACK-ROL25	10 m ² (1 x 10 m ²)	1000x10.000x25mm - 4kPa - 33dB	
UFH-TACK-ROL30	10 m ² (1 x 10 m ²)	1000x10.000x30mm - 4kPa - 33dB	
UFH-TACK-ROL35	10 m ² (1 x 10 m ²)	1000x10.000x35mm - 4kPa - 33dB	

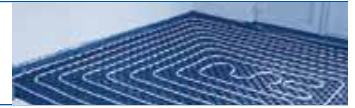

Type: UFH-TACK-38K



Tacker clip, 38 mm
Tackernagel, 38 mm
Agrafe tacker, 38 mm
Tackernadel, 38 mm

Article number	Box / Big Box	Type	Subgroup
UFH-TACK-38K*	300 pc. / 6000 pc.	38 mm	

* Pipe Ø 16

Type: UFH-TACK-40



Tacker clip, 40 mm
Tackernagel, 40 mm
Agrafe tacker, 40 mm
Tackernadel, 40 mm

Article number	Box / Big Box	Type	Subgroup
UFH-TACK-40*	300 pc. / 4.800 pc.	40 mm	

* Pipe Ø 16-20

Type: UFH-TACK-60



Tacker clip, 60 mm
Tackernagel, 60 mm
Agrafe tacker, 60 mm
Tackernadel, 60 mm

Article number	Box / Big Box	Type	Subgroup
UFH-TACK-60*	300 pc. / 3.600 pc.	60 mm	

* Rohr Ø 16-20

Type: UFH-SCOTCH-66



Adhesive tape
Kleefband
Ruban adhésif
Klebeband

Article number	Packing	Type	Subgroup
UFH-SCOTCH-66	1 pc.	66 m	

- 1
- 2
- 3
- 4
- 5
- 6
- 7
- 8
- 9
- 10
- 11

Type: UFH-P18-GP18



Gypsum board 18mm, round milling for RENO12 system
 Gipsvezelplaat 18mm, ronde frezing voor RENO12 systeem
 Plaques en fibre-plâtre 18mm, avec une fraisage circulaire système RENO12
 Gipsfaserplatte 18mm, runde Fräsung für das RENO12 system

Article number	pc	Type	Subgroup
UFH-P18-GP18	1 pc.	1000 x 600 x 18mm	

Type: UFH-P18-GP18V



Gypsum board 18mm, vertical milling for RENO12 system
 Gipsvezelplaat 18mm, verticale frezing voor RENO12 systeem
 Plaques en fibre-plâtre 18mm, système RENO12
 Gipsfaserplatte 18mm, vertikale Fräsung für das RENO12 system

Article number	pc	Type	Subgroup
UFH-P18-GP18V	1 pc.	1000 x 600 x 18mm	

Type: UFH-P18-GP10



Gypsum board 10mm, flat for RENO12 system
 Gipsvezelplaat 10mm, vlak voor RENO12 systeem
 Plaques en fibre-plâtre 10mm, système RENO12
 Gipsfaserplatte 10mm, flach für das RENO12 system

Article number	pc	Type	Subgroup
UFH-P18-GP10	1 pc.	1500 x 1000 x 10mm	

Type: UFH-P18-WN



Mesh for RENO12 system
 Wapeningsnet voor RENO12 systeem
 Treillis d'armature système RENO12
 Betonstahlmatte für das RENO12 system

Article number	Packing	Type	Subgroup
UFH-P18-WN	50 m ²	1 x 50m	

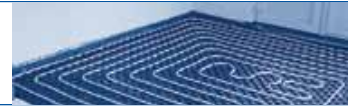

Type: UFH-P18-EGA



Filler for RENO12 system
 Egaliseermiddel voor RENO12 systeem
 Remplissage système RENO12
 Nivilier Estrich für das RENO12 system

Article number	Bag	Type	Subgroup
UFH-P18-EGA	25 kg		

- 1
- 2
- 3
- 4
- 5
- 6
- 7
- 8
- 9
- 10
- 11

Type: UFH-P18-VL



Adhesive for joints
 Voegenlijm voor RENO12 systeem
 Colle pour les joints système RENO12
 Fugeklebstoff für das RENO12 system

Article number	pc	Type	Subgroup
UFH-P18-VL	1 pc.	310 ml	

Type: UFH-P18-SC



Screw for RENO12 system
 Snelbouwschroeven voor RENO12 systeem
 Vis système RENO12
 Schraube für das RENO12 system

Article number	Box	Type	Subgroup
UFH-P18-SC	1000 pc.	3,9 x 55 mm	

Type: UFH-ISODRY-25



Insulation system board for dry system
 Isolatieplaat voor droog systeem
 Panneau d'isolation pour système sec
 Systemplatte für Trockenbau

Article number	Packing	Type	Subgroup
UFH-ISODRY-25	10 m ²	1000x500x25mm	

Type: UFH-DRY-GP100-2



Heat diffusion profile for dry system
Stralingsprofiel voor droog systeem
Profil de diffusion pour système sec
Wärmeleitlamelle für Trockenbau

Article number	Packing	Type	Subgroup
UFH-DRY-GP100-2	50 pc.	997x120x0,4mm - Ø16	

Type: UFH-DRY-VD100



Heat diffusion board for dry system
Stralingsverdeelplaat voor droog systeem
Panneau de diffusion pour système sec
Verteilerbleche für Trockenbau

Article number	Packing	Type	Subgroup
UFH-DRY-VD100	1 pc.	1000x1000mm	

Type: UFH-DRY-B



Synthetic mounting bracket for pipe in diagonal position
kunststofbeugel voor bevestiging buis bij diagonaalverlegging
Fixation en plastique pour pose du tube diagonal
Kunststoffreiter für Diagonalverlegung

Article number	Packing	Type	Subgroup
UFH-DRY-B	100		

Type: UFH-UP-M



Clip rail with adhesive strip, centres 50 mm
U-profiel met kleefband, verlegafstand 50 mm
Profil-U avec bande adhésif, distance de pose 50 mm
Kunststoffclip-Schiene klebfertig für Rohr, Verlegung 50 mm

Article number	Box / Pallet	Type	Subgroup
UFH-UP-14M1	100 m / 1000 m	Ø14 - AS25 mm - 1000 mm	
UFH-UP-16M1	100 m / 1000 m	Ø16 - AS50 mm - 1000 mm	

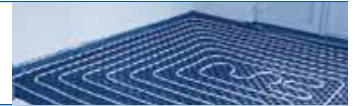

Type: UFH-UP



Clip rail with adhesive strip, centres 50 mm
 U-profiel met kleefband, verlegafstand 50 mm
 Profil-U avec bande adhésif, distance de pose 50 mm
 Kunststoffclip-Schiene klebfertig für Rohr, Verlegung 50 mm

Article number	Box / Pallet	Type	Subgroup
UFH-UP-12	32 m / 960 m	Ø12 - AS25 mm- 2000 mm	
UFH-UP-14	100 m / 2500 m	Ø14 - AS25 mm- 2500 mm	
UFH-UP-16	100 m / 3000 m	Ø16 - AS50 mm- 2500 mm	
UFH-UP-20	100 m / 896 m	Ø20 - AS50 mm- 2000 mm	

- 1
- 2
- 3
- 4
- 5
- 6
- 7
- 8
- 9
- 10
- 11

Type: UFH-UP-Z



Clip rail without adhesive strip, centres 50 mm
 U-profiel zonder kleefband, verlegafstand 50 mm
 Profil-U sans bande adhésif, distance de pose 50 mm
 Kunststoffclip-Schiene nicht klebfertig, Verlegung 50 mm

Article number	Box / Pallet	Type	Subgroup
UFH-UP-1826M1Z	50 m / 600 m	Ø18, 20, 26 - AS50 mm - 1000	

Type: UFH-UP-CUP



Staple for clip rail
 Clip voor U-profielen
 Agrafe pour profil-U
 Nadel für Schienen

Article number	Box / Big Box	Type	Subgroup
UFH-UP-CUP50	500 pc. / 9000 pc.	50 mm	

Type: UFH-FOIL



PE film, transparant, with blue grid marking 50 x 50 mm
 PE-folie, transparant, blauwe rastermarkering 50 x 50 mm
 Film en PE, transparent avec marquage 50 x 50 mm en bleu
 Polyethylen-Schutzfolie, transparent, Markierung Blau 50x50mm

Article number	Packing	Type	Subgroup
UFH-FOL50	51 m ²	34m x 1,5m - 0,2mm	
UFH-FOL90	90 m ²	60m x 1,5m - 0,2mm	

Type: UFH-FOIL-N



PE lm, neutral
 PE-folie, neutraal
 Film en PE, neutre
 Polyethylen-Schutzfolie, neutral

Article number	Packing	Type	Subgroup
UFH-FOL-N	100 m ²	50 m x 2 m - 0,2 mm	

Type: UFH-FOIL-ALU



PE lm, reflecting ALU
 PE-folie, met PE-ap en ALU reflectie
 Film en PE avec reection ALU
 Polyethylen-Schutzfolie, Reflexion ALU

Article number	Packing	Type	Subgroup
UFH-FOL-ALU	50 m ²	50 m x 1 m - 3,0 mm	

Type: UFH-FOIL-CLIP25



Clip for Film
 Dampfolienagel
 Agrafe pour lm PE
 Foliendubel

Article number	Packing	Type	Subgroup
UFH-FOL-CLIP25	100 pc.	25 mm	

Type: UFH-PLUG80



Plug, shaft length 80 mm, 8 mm
 Montageplug, schachtlengte 80 mm, 8 mm
 Cheville de montage, longueur 80 mm, 8 mm
 Niederhaltedubel, Bohrer  8 mm, Schaftlnge 80 mm

Article number	Packing	Type	Subgroup
UFH-PLUG80	100 pc.	80 mm, 8 mm	



Type: UFH-ISOBOARD-S



PE edge isolation with lapping strip and adhesive strip
 Randisolatie uit PE-schuim met PE-lap en kleefstroken
 Isolation périphérique en PE avec rabat et bande adhésif
 Randdämmstreifen aus PE mit Abrisskante und Klebestreifen

Article number	Packing	Type	Subgroup
UFH-ISOBOARD-S	25 m	150 x 8 mm	

- 1
- 2
- 3
- 4
- 5
- 6
- 7
- 8
- 9
- 10
- 11

Type: UFH-ISOBOARD-G



PE edge isolation with lapping strip and adhesive strip for liquid floors
 Randisolatie voor gietvloeren uit PE-schuim met lap en kleefstroken
 Isolation périphérique en PE avec rabat et bande adhésif, pour chape anhydrite
 Randdämmstreifen aus PE mit Abrisskante und Klebestreifen, für Fliessestrich

Article number	Packing	Type	Subgroup
UFH-ISOBOARD-G	25 m	150 mm x 8 mm	

Type: UFH-DP200



PE expansion joint with self-adhesive rail
 Uitzettingsvoeg uit PE-schuim met zelfklevende rail
 Joint de dilatation en PE avec bande adhésive
 Dehnungsfuge aus PE mit Klebestreifen

Article number	Packing	Type	Subgroup
UFH-DP200	2 m	2000 mm x 100 mm x 8 mm	

Type: UFH-DH40



Protection sleeve for expansion joint
 Voegdoorganghuls
 Gaine de protection pour joint de dilatation
 Schutzrohre für Dehnungsfugen

Article number	Packing	Type	Subgroup
UFH-DH40	100 pc.	400 mm - ID20 OD25	

Type: UFH-BEND



Bend guide for pipe
 Geleidingsbocht voor buis
 Courbe pour tube
 Rohrführungsbogen

Article number	Packing	Type	Subgroup
UFH-BEND1218	1 pc.	Ø12 - 18 mm	
UFH-BEND20	1 pc.	Ø20 mm	

Type: UFH-ADN10



Additive for screed (min. pipe covering 45 mm)
 Toevoegmiddel voor zandcementdekvloer (min. buisoverdekking 45 mm)
 Additif pour chape de ciment (min. épaisseur de chape au-dessus du tube 45 mm)
 Estrichzusatz (min. Rohrüberdeckung 45 mm)

Article number	Packing	Type	Subgroup
UFH-ADN10	10 L		

Type: UFH-MP01



Indication tool to measure humidity level of screed
 Meethulp voor voorgeschreven restvochtmeting van de dekvloer
 Outil de marquage pour mesurer l'humidité du chape
 Estrichmessstelle

Article number	Packing	Type	Subgroup
UFH-MP01	1 pc.		

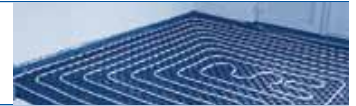

Type: UFH-06-MD



Manifold brass, adjustable, with flow meters
 Verdeler messing, regelbaar, met debietmeting
 Collecteur en laiton, réglable, avec débitmètres
 Verteiler aus Messing, regelbar, mit Durchflussmengenzähler

Article number	Packing	Type	Subgroup
UFH+060502-MD	1 pc.	1"M- 2 x 3/4"EK	
UFH+060503-MD	1 pc.	1"M- 3 x 3/4"EK	
UFH+060504-MD	1 pc.	1"M- 4 x 3/4"EK	
UFH+060505-MD	1 pc.	1"M- 5 x 3/4"EK	
UFH+060506-MD	1 pc.	1"M- 6 x 3/4"EK	
UFH+060507-MD	1 pc.	1"M- 7 x 3/4"EK	
UFH+060508-MD	1 pc.	1"M- 8 x 3/4"EK	
UFH+060509-MD	1 pc.	1"M- 9 x 3/4"EK	
UFH+060510-MD	1 pc.	1"M- 10 x 3/4"EK	
UFH+060511-MD	1 pc.	1"M- 11 x 3/4"EK	
UFH+060512-MD	1 pc.	1"M- 12 x 3/4"EK	

- 1
- 2
- 3
- 4
- 5
- 6
- 7
- 8
- 9
- 10
- 11

Type: UFH-06-MR



Manifold brass, adjustable
 Verdeler messing, regelbaar
 Collecteur en laiton, réglable
 Verteiler aus Messing, regelbar

Article number	Packing	Type	Subgroup
UFH+060502-MR	1 pc.	1"M- 2 x 3/4"EK	
UFH+060503-MR	1 pc.	1"M- 3 x 3/4"EK	
UFH+060504-MR	1 pc.	1"M- 4 x 3/4"EK	
UFH+060505-MR	1 pc.	1"M- 5 x 3/4"EK	
UFH+060506-MR	1 pc.	1"M- 6 x 3/4"EK	
UFH+060507-MR	1 pc.	1"M- 7 x 3/4"EK	
UFH+060508-MR	1 pc.	1"M- 8 x 3/4"EK	
UFH+060509-MR	1 pc.	1"M- 9 x 3/4"EK	
UFH+060510-MR	1 pc.	1"M- 10 x 3/4"EK	
UFH+060511-MR	1 pc.	1"M- 11 x 3/4"EK	
UFH+060512-MR	1 pc.	1"M- 12 x 3/4"EK	

Type: UFH-M-D



Flow meter for brass manifold
 Debitmeter voor messing verdeler
 Débitmètre pour collecteur en laiton
 Durchflussmengenanzeiger für Verteiler aus Messing

Article number	Packing	Type	Subgroup
• UFH-M-D	1 pc.		

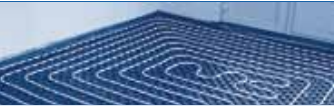

B. MANIFOLDS

Type: UFH-PGFM



Pump unit Floormix
 Pompgroep Floormix
 Kit pompe Floormix
 Pumpe Floormix

Article number	Packing	Type	Subgroup
UFH-PGFM01	1 pc.		

Type: UFH-PGKTA



Pump unit A label pump with consistent temperature control
 Pompgroep A-label met regeling voor constante temperatuur
 Kit pompe label A avec régulation de température constante
 Konstanttemperaturregelung mit A-Pumpe

Article number	Packing	Type	Subgroup
• UFH-PGKTA	1 pc.	1°F / 27°C- 42°C	

Type: UFH-GKT



Unit with consistent temperature control without pump
 Groep met regeling voor constante temperatuur zonder pomp
 Kit avec régulation de température constante sans pompe
 Konstanttemperaturregelung ohne Pump

Article number	Packing	Type	Subgroup
UFH-GKT	1 pc.	1°F / 27°C- 42°C	

Type: UFH-BT-M



1" F ball valve with 1" F swivel nut, washer and thermometer
 Kogelkraan 1" F met wartelmoer 1" F , dichting en thermometer
 Vanne à sphère 1" F avec écrou 1" F, joint et thermomètre
 Kugelhahnset 1" IG mit Mutter 1" IG , Dichtung und Thermometer

Article number	Packing	Type	Subgroup
UFH-BTM0606-M	1 set (2 pc.)	1"Fx 1" F / 0 - 60 °	

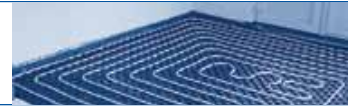

Type: UFH-B-M



1"F ball valve with 1"F swivel nut and washer
Kogelkraan 1"F met wartelmoer 1"F en dichting
Vanne à sphère 1" F avec écrou 1" F et joint plat
Kugelhahnset 1" IG mit Mutter 1" IG und Dichtung

Article number	Packing	Type	Subgroup
UFH-B0606-M	1 set (2 pc.)	1"Fx1"F	

1

2

3

4

5

6

7

8

9

10

11

Type: UFH-ESK-M



1"F end cap with nut, washer, ball valve and air vent 3/8"
Eindstuk 1"F met moer, dichting, kogelkraan en ontluchtingskraan 3/8"
Bouchon terminal 1" F avec écrou, vanne à sphère, joint et purgeur 3/8"
Verteilerendstückset 1" IG mit Mutter und Dichtung, Entlüftung 3/8", Kugelhahnset, Entleerung 1/2"

Article number	Packing	Type	Subgroup
UFH-ESK060303-M	1 set (2 pc.)	1"F x 1/2" x 3/8"	

Type: UFH-AO-MZ



Automatic air vent, without check valve
Automatische ontluchter, zonder waterslot
Purgeur automatique, sans serrure d'eau
Schnellentlüfter mit vertikaler Entlüftung, ohne Wasserabsperrung

Article number	Packing	Type	Subgroup
UFH-AO03-MZ	1 pc.	3/8"	

Type: UFH-TM-M



Thermometer for return with EK connections
Thermometer voor terugvoer met euroconus aansluitingen
Retour thermomètre avec raccordement eurocone
Thermometer zum Anschluss Rucklauf mit Eurokonus-Anschlüssen

Article number	Packing	Type	Subgroup
UFH-TM050-M	1 pc.	3/4" EK- 3/4"EK/ 0	

B. MANIFOLDS

Type: UFH-BS-M



End cap with washer
Blindstop
Bouchon
Kappe mit Dichtung

Article number	Packing	Type	Subgroup
UFHBS05-M	1 pc.	3/4"	

Type: UFH-06-RVSD



Manifold Stainless steel, adjustable, with flow meters
Verdeler roestvrij staal, regelbaar, met debietmeting
Collecteur acier inoxydable, réglable, avec débitmètres
Verteiler aus Edelstahl, regelbar, mit Durchflüssenmengenähler

Article number	Packing	Type	Subgroup
UFH060502-RVSD	1 pc.	1"M- 2 x 3/4"EK	
UFH060503-RVSD	1 pc.	1"M- 3 x 3/4"EK	
UFH060504-RVSD	1 pc.	1"M- 4 x 3/4"EK	
UFH060505-RVSD	1 pc.	1"M- 5 x 3/4"EK	
UFH060506-RVSD	1 pc.	1"M- 6 x 3/4"EK	
UFH060507-RVSD	1 pc.	1"M- 7 x 3/4"EK	
UFH060508-RVSD	1 pc.	1"M- 8 x 3/4"EK	
UFH060509-RVSD	1 pc.	1"M- 9 x 3/4"EK	
UFH060510-RVSD	1 pc.	1"M- 10 x 3/4"EK	
UFH060511-RVSD	1 pc.	1"M- 11 x 3/4"EK	
UFH060512-RVSD	1 pc.	1"M- 12 x 3/4"EK	

Type: UFH-BT-VN



1" F ball valve with 1" F swivel nut, washer and thermometer, nickel-plated
Kogelkraan 1" F met wartelmoer 1" F, dichting en thermometer, vernikkeld
Vanne à sphère 1" F avec écrou 1" F, joint et thermomètre, nickelé
Kugelhahnset 1" IG mit Mutter 1" IG, Dichtung und Thermometer, vernickelt

Article number	Packing	Type	Subgroup
UFHBTM0606-VN	1 set (2 pc.)	1" F x 1" F	

Type: UFH-B-VN



1" F ball valve with 1" F swivel nut and washer, nickel-plated
Kogelkraan 1" F met wartelmoer 1" F en dichting, vernikkeld
Vanne à sphère 1" F avec écrou 1" F et joint, nickelé
Kugelhahnset 1" IG mit Mutter 1" IG und Dichtung, vernickelt

Article number	Packing	Type	Subgroup
UFHB0606-VN	1 set (2 pc.)	1" F x 1" F / 0 - 60°	

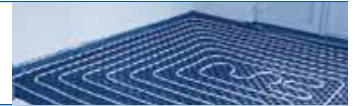

Type: UFH-ESK-VN



1" F end cap with nut, washer, ball valve and air vent 3/8", nickel-plated
Eindstuk 1" F met moer, dichting, kogelkraan en ontluchtingskraan 3/8", vernikkeld

Bouchon terminal 1" F avec écrou, joint et purgeur 3/8", nickelé
Verteilerendstückset 1" IG mit Mutter und Dichtung, Entlüftung 3/8", Kugelhahnset, vernickelt

Article number	Packing	Type	Subgroup
UFH-ESK060303-VN	1 set (2 pc.)	1" F x 1/2" x 3/8"	

Type: UFH-CD



Manifold composite, adjustable with flow meter

Composiet verdeler, regelbaar met debietmeting

Collecteur composite, réglable avec débitmètre

Verteiler Composite, regelbar mit Durchflüssenmengenähler

Article number	Packing	Type	Subgroup
UFH+0605CD01	1 pc.	1" - 1 x 3/4"	
UFH+0605CD02	1 pc.	1" - 2 x 3/4"	
UFH+0605CD03	1 pc.	1" - 3 x 3/4"	
UFH+0605CD04	1 pc.	1" - 4 x 3/4"	
UFH+0605CD05	1 pc.	1" - 5 x 3/4"	
UFH+0605CD06	1 pc.	1" - 6 x 3/4"	
UFH+0605CD07	1 pc.	1" - 7 x 3/4"	
UFH+0605CD08	1 pc.	1" - 8 x 3/4"	
UFH+0605CD09	1 pc.	1" - 9 x 3/4"	
UFH+0605CD10	1 pc.	1" - 10 x 3/4"	
UFH+0605CD11	1 pc.	1" - 11 x 3/4"	
UFH+0605CD12	1 pc.	1" - 12 x 3/4"	
UFH+0605CD13	1 pc.	1" - 13 x 3/4"	
UFH+0605CD14	1 pc.	1" - 14 x 3/4"	
UFH+0605CD15	1 pc.	1" - 15 x 3/4"	
UFH+0605CD16	1 pc.	1" - 16 x 3/4"	
UFH+0605CD17	1 pc.	1" - 17 x 3/4"	
UFH+0605CD18	1 pc.	1" - 18 x 3/4"	
UFH+0605CD19	1 pc.	1" - 19 x 3/4"	
UFH+0605CD20	1 pc.	1" - 20 x 3/4"	

- 1
- 2
- 3
- 4
- 5
- 6
- 7
- 8
- 9
- 10
- 11

B. MANIFOLDS

Type: UFH-CDP



Manifold composite, adjustable with flow meter and A-pump
 Composiet verdeler, regelbaar met debietmeting en A-pomp
 Collecteur composite, réglable avec débitmètre et pompe label A
 Verteiler Composite, regelbar mit Durchflüssenmengenähler und A-Pumpe

Article number	Packing	Type	Subgroup
UFH+0405CDF01	1 pc.	1/2" - 1 x 3/4"	
UFH+0405CDF02	1 pc.	1/2" - 2 x 3/4"	
UFH+0405CDF03	1 pc.	1/2" - 3 x 3/4"	
UFH+0405CDF04	1 pc.	1/2" - 4 x 3/4"	
UFH+0405CDF05	1 pc.	1/2" - 5 x 3/4"	
UFH+0405CDF06	1 pc.	1/2" - 6 x 3/4"	
UFH+0505CDF07	1 pc.	3/4" - 7 x 3/4"	
UFH+0505CDF08	1 pc.	3/4" - 8 x 3/4"	
UFH+0505CDF09	1 pc.	3/4" - 9 x 3/4"	
UFH+0505CDF10	1 pc.	3/4" - 10 x 3/4"	
UFH+0505CDF11	1 pc.	3/4" - 11 x 3/4"	
UFH+0505CDF12	1 pc.	3/4" - 12 x 3/4"	
UFH+0505CDF13	1 pc.	3/4" - 13 x 3/4"	
UFH+0505CDF14	1 pc.	3/4" - 14 x 3/4"	
UFH+0505CDF15	1 pc.	3/4" - 15 x 3/4"	
UFH+0505CDF16	1 pc.	3/4" - 16 x 3/4"	

Type: UFH-CAF



Manifold composite, adjustable with active flow control
 Composiet verdeler, regelbaar met active flow control
 Collecteur composite, réglable avec active flow control
 Verteiler Composite, regelbar mit active flow control

Article number	Packing	Type	Subgroup
UFH+0605CAF01	1 pc.	1" - 1 x 3/4"	
UFH+0605CAF02	1 pc.	1" - 2 x 3/4"	
UFH+0605CAF03	1 pc.	1" - 3 x 3/4"	
UFH+0605CAF04	1 pc.	1" - 4 x 3/4"	
UFH+0605CAF05	1 pc.	1" - 5 x 3/4"	
UFH+0605CAF06	1 pc.	1" - 6 x 3/4"	
UFH+0605CAF07	1 pc.	1" - 7 x 3/4"	
UFH+0605CAF08	1 pc.	1" - 8 x 3/4"	
UFH+0605CAF09	1 pc.	1" - 9 x 3/4"	
UFH+0605CAF10	1 pc.	1" - 10 x 3/4"	
UFH+0605CAF11	1 pc.	1" - 11 x 3/4"	
UFH+0605CAF12	1 pc.	1" - 12 x 3/4"	
UFH+0605CAF13	1 pc.	1" - 13 x 3/4"	
UFH+0605CAF14	1 pc.	1" - 14 x 3/4"	
UFH+0605CAF15	1 pc.	1" - 15 x 3/4"	
UFH+0605CAF16	1 pc.	1" - 16 x 3/4"	
UFH+0605CAF17	1 pc.	1" - 17 x 3/4"	
UFH+0605CAF18	1 pc.	1" - 18 x 3/4"	
UFH+0605CAF19	1 pc.	1" - 19 x 3/4"	
UFH+0605CAF20	1 pc.	1" - 20 x 3/4"	

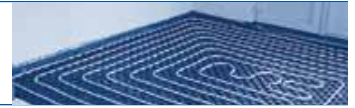

Type: UFH-CAFP



Manifold composite, adjustable with active flow control and A-pump
 Composiet verdeler, regelbaar met active flow control en A-pomp
 Collecteur composite, réglable avec active flow control et pompe label A
 Verteiler Composite, regelbar mit active flow control und A-Pumpe

Article number	Packing	Type	Subgroup
UFH+0405CAFP01	1 pc.	1/2" - 1 x 3/4"	
UFH+0405CAFP02	1 pc.	1/2" - 2 x 3/4"	
UFH+0405CAFP03	1 pc.	1/2" - 3 x 3/4"	
UFH+0405CAFP04	1 pc.	1/2" - 4 x 3/4"	
UFH+0405CAFP05	1 pc.	1/2" - 5 x 3/4"	
UFH+0405CAFP06	1 pc.	1/2" - 6 x 3/4"	
UFH+0505CAFP07	1 pc.	3/4" - 7 x 3/4"	
UFH+0505CAFP08	1 pc.	3/4" - 8 x 3/4"	
UFH+0505CAFP09	1 pc.	3/4" - 9 x 3/4"	
UFH+0505CAFP10	1 pc.	3/4" - 10 x 3/4"	
UFH+0505CAFP11	1 pc.	3/4" - 11 x 3/4"	
UFH+0505CAFP12	1 pc.	3/4" - 12 x 3/4"	
UFH+0505CAFP13	1 pc.	3/4" - 13 x 3/4"	
UFH+0505CAFP14	1 pc.	3/4" - 14 x 3/4"	
UFH+0505CAFP15	1 pc.	3/4" - 15 x 3/4"	
UFH+0505CAFP16	1 pc.	3/4" - 16 x 3/4"	

- 1
- 2
- 3
- 4
- 5
- 6
- 7
- 8
- 9
- 10
- 11

Type: UFH-CD3W

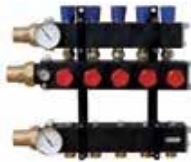

Manifold composite 3-way, adjustable with flow meter
 Composiet verdeler 3-pijps, regelbaar met debietmeting
 Collecteur composite 3 voies, réglable avec débitmètre
 Verteiler Composite 3wegs, regelbar mit Durchflussmengenähler

Article number	Packing	Type	Subgroup
UFH+0605CD3W01	1 pc.	1" - 1 x 3/4"	
UFH+0605CD3W02	1 pc.	1" - 2 x 3/4"	
UFH+0605CD3W03	1 pc.	1" - 3 x 3/4"	
UFH+0605CD3W04	1 pc.	1" - 4 x 3/4"	
UFH+0605CD3W05	1 pc.	1" - 5 x 3/4"	
UFH+0605CD3W06	1 pc.	1" - 6 x 3/4"	
UFH+0605CD3W07	1 pc.	1" - 7 x 3/4"	
UFH+0605CD3W08	1 pc.	1" - 8 x 3/4"	
UFH+0605CD3W09	1 pc.	1" - 9 x 3/4"	
UFH+0605CD3W10	1 pc.	1" - 10 x 3/4"	
UFH+0605CD3W11	1 pc.	1" - 11 x 3/4"	
UFH+0605CD3W12	1 pc.	1" - 12 x 3/4"	
UFH+0605CD3W13	1 pc.	1" - 13 x 3/4"	
UFH+0605CD3W14	1 pc.	1" - 14 x 3/4"	
UFH+0605CD3W15	1 pc.	1" - 15 x 3/4"	
UFH+0605CD3W16	1 pc.	1" - 16 x 3/4"	
UFH+0605CD3W17	1 pc.	1" - 17 x 3/4"	
UFH+0605CD3W18	1 pc.	1" - 18 x 3/4"	
UFH+0605CD3W19	1 pc.	1" - 19 x 3/4"	
UFH+0605CD3W20	1 pc.	1" - 20 x 3/4"	

B. MANIFOLDS

Type: UFH-CD4W



Manifold composite 4-way, adjustable with flow meter
 Composiet verdeler 4-pijps, regelbaar met debietmeting
 Collecteur composite 4 voies, réglable avec débitmètre
 Verteiler Composite 4wegs, regelbaar mit Durchflüssenmengenzähler

Article number	Packing	Type	Subgroup
UFH+0605CD4W01	1 pc.	1" - 1 x 3/4"	
UFH+0605CD4W02	1 pc.	1" - 2 x 3/4"	
UFH+0605CD4W03	1 pc.	1" - 3 x 3/4"	
UFH+0605CD4W04	1 pc.	1" - 4 x 3/4"	
UFH+0605CD4W05	1 pc.	1" - 5 x 3/4"	
UFH+0605CD4W06	1 pc.	1" - 6 x 3/4"	
UFH+0605CD4W07	1 pc.	1" - 7 x 3/4"	
UFH+0605CD4W08	1 pc.	1" - 8 x 3/4"	
UFH+0605CD4W09	1 pc.	1" - 9 x 3/4"	
UFH+0605CD4W10	1 pc.	1" - 10 x 3/4"	
UFH+0605CD4W11	1 pc.	1" - 11 x 3/4"	
UFH+0605CD4W12	1 pc.	1" - 12 x 3/4"	
UFH+0605CD4W13	1 pc.	1" - 13 x 3/4"	
UFH+0605CD4W14	1 pc.	1" - 14 x 3/4"	
UFH+0605CD4W15	1 pc.	1" - 15 x 3/4"	
UFH+0605CD4W16	1 pc.	1" - 16 x 3/4"	
UFH+0605CD4W17	1 pc.	1" - 17 x 3/4"	
UFH+0605CD4W18	1 pc.	1" - 18 x 3/4"	
UFH+0605CD4W19	1 pc.	1" - 19 x 3/4"	
UFH+0605CD4W20	1 pc.	1" - 20 x 3/4"	

Type: UFH-CDWE



Manifold composite project che with heat exchanger and dirt separator
 Composiet verdeler project cwe met warmtewisselaar en vuilafscheider
 Collecteur composite projet cev avec échangeur de chaleur et séparateur de boue

Verteiler Composite projekt cwa mit Wärmetauscher und Schlammabscheider

Article number	Packing	Type	Subgroup
UFH+0505CDWE01	1 pc.	3/4" - 1 x 3/4"	
UFH+0505CDWE02	1 pc.	3/4" - 2 x 3/4"	
UFH+0505CDWE03	1 pc.	3/4" - 3 x 3/4"	
UFH+0505CDWE04	1 pc.	3/4" - 4 x 3/4"	
UFH+0505CDWE05	1 pc.	3/4" - 5 x 3/4"	
UFH+0505CDWE06	1 pc.	3/4" - 6 x 3/4"	
UFH+0505CDWE07	1 pc.	3/4" - 7 x 3/4"	
UFH+0505CDWE08	1 pc.	3/4" - 8 x 3/4"	
UFH+0505CDWE09	1 pc.	3/4" - 9 x 3/4"	
UFH+0505CDWE10	1 pc.	3/4" - 10 x 3/4"	
UFH+0505CDWE11	1 pc.	3/4" - 11 x 3/4"	
UFH+0505CDWE12	1 pc.	3/4" - 12 x 3/4"	
UFH+0505CDWE13	1 pc.	3/4" - 13 x 3/4"	
UFH+0505CDWE14	1 pc.	3/4" - 14 x 3/4"	
UFH+0505CDWE15	1 pc.	3/4" - 15 x 3/4"	
UFH+0505CDWE16	1 pc.	3/4" - 16 x 3/4"	

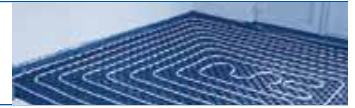

Type: UFH-CP



A-pump unit for composite collector
 Pompunit composiet verdeler, met A-pomp
 Kit pompe-A pour collecteur composite
 A-Pump Unit für Composite Verteiler

Article number	Packing	Type	Subgroup
UFH-CP	1 pc.		

- 1
- 2
- 3
- 4
- 5
- 6
- 7
- 8
- 9
- 10
- 11

Type: UFH-S



Steel collector with pump
 Stalen verdeler met pomp
 Collecteur en acier avec pompe
 Verteiler Stahl mit Pump

Article number	Packing	Type	Subgroup
UFH+0405S01	1 pc.	1/2" - 1 x 3/4"	
UFH+0405S02	1 pc.	1/2" - 2 x 3/4"	
UFH+0405S03	1 pc.	1/2" - 3 x 3/4"	
UFH+0405S04	1 pc.	1/2" - 4 x 3/4"	
UFH+0405S05	1 pc.	1/2" - 5 x 3/4"	
UFH+0405S06	1 pc.	1/2" - 6 x 3/4"	
UFH+0505S07	1 pc.	3/4" - 7 x 3/4"	
UFH+0505S08	1 pc.	3/4" - 8 x 3/4"	
UFH+0505S09	1 pc.	3/4" - 9 x 3/4"	
UFH+0505S10	1 pc.	3/4" - 10 x 3/4"	
UFH+0505S11	1 pc.	3/4" - 11 x 3/4"	
UFH+0505S12	1 pc.	3/4" - 12 x 3/4"	
UFH+0505S13	1 pc.	3/4" - 13 x 3/4"	
UFH+0505S14	1 pc.	3/4" - 14 x 3/4"	
UFH+0505S15	1 pc.	3/4" - 15 x 3/4"	
UFH+0505S16	1 pc.	3/4" - 16 x 3/4"	

TILL EXHAUSTION OF STOCK

B. MANIFOLDS

Type: UFH-SECO



Steel collector with A-pump
 Stalen verdeler met A-pomp
 Collecteur en acier avec pompe label A
 Verteiler Stahl mit A-Pump

Article number	Packing	Type	Subgroup
UFH-0405SECO01	1 pc.	1/2" - 1 x 3/4"	
UFH-0405SECO02	1 pc.	1/2" - 2 x 3/4"	
UFH-0405SECO03	1 pc.	1/2" - 3 x 3/4"	
UFH-0405SECO04	1 pc.	1/2" - 4 x 3/4"	
UFH-0405SECO05	1 pc.	1/2" - 5 x 3/4"	
UFH-0405SECO06	1 pc.	1/2" - 6 x 3/4"	
UFH-0505SECO07	1 pc.	3/4" - 7 x 3/4"	
UFH-0505SECO08	1 pc.	3/4" - 8 x 3/4"	
UFH-0505SECO09	1 pc.	3/4" - 9 x 3/4"	
UFH-0505SECO10	1 pc.	3/4" - 10 x 3/4"	
UFH-0505SECO11	1 pc.	3/4" - 11 x 3/4"	
UFH-0505SECO12	1 pc.	3/4" - 12 x 3/4"	
UFH-0505SECO13	1 pc.	3/4" - 13 x 3/4"	
UFH-0505SECO14	1 pc.	3/4" - 14 x 3/4"	
UFH-0505SECO15	1 pc.	3/4" - 15 x 3/4"	
UFH-0505SECO16	1 pc.	3/4" - 16 x 3/4"	

Type: UFH-SSTN



Steel collector with pump, district heating nuon and eneco
 Stalen verdeler met pomp, stadsverwarming nuon en eneco
 Collecteur en acier avec pompe, chauffage urbain nuon et eneco
 Verteiler Stahl mit Pump, Fernheizung nuon und eneco

Article number	Packing	Type	Subgroup
UFH-0405SSTN01	1 pc.	1/2" - 1 x 3/4"	
UFH-0405SSTN02	1 pc.	1/2" - 2 x 3/4"	
UFH-0405SSTN03	1 pc.	1/2" - 3 x 3/4"	
UFH-0405SSTN04	1 pc.	1/2" - 4 x 3/4"	
UFH-0405SSTN05	1 pc.	1/2" - 5 x 3/4"	
UFH-0405SSTN06	1 pc.	1/2" - 6 x 3/4"	
UFH-0505SSTN07	1 pc.	3/4" - 7 x 3/4"	
UFH-0505SSTN08	1 pc.	3/4" - 8 x 3/4"	
UFH-0505SSTN09	1 pc.	3/4" - 9 x 3/4"	
UFH-0505SSTN10	1 pc.	3/4" - 10 x 3/4"	
UFH-0505SSTN11	1 pc.	3/4" - 11 x 3/4"	
UFH-0505SSTN12	1 pc.	3/4" - 12 x 3/4"	

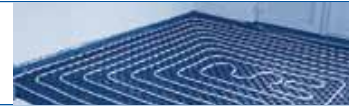

Type: UFH-SSTE



Steel collector with pump, district heating essent
 Stalen verdeler met pomp, stadsverwarming essent
 Collecteur en acier avec pompe, chauffage urbain essent
 Verteiler Stahl mit Pump, Fernheizung essent

Article number	Packing	Type	Subgroup
UFH+0405SSTE01	1 pc.	1/2" - 1 x 3/4"	
UFH+0405SSTE02	1 pc.	1/2" - 2 x 3/4"	
UFH+0405SSTE03	1 pc.	1/2" - 3 x 3/4"	
UFH+0405SSTE04	1 pc.	1/2" - 4 x 3/4"	
UFH+0405SSTE05	1 pc.	1/2" - 5 x 3/4"	
UFH+0405SSTE06	1 pc.	1/2" - 6 x 3/4"	
UFH+0505SSTE07	1 pc.	3/4" - 7 x 3/4"	
UFH+0505SSTE08	1 pc.	3/4" - 8 x 3/4"	
UFH+0505SSTE09	1 pc.	3/4" - 9 x 3/4"	
UFH+0505SSTE10	1 pc.	3/4" - 10 x 3/4"	
UFH+0505SSTE11	1 pc.	3/4" - 11 x 3/4"	
UFH+0505SSTE12	1 pc.	3/4" - 12 x 3/4"	

- 1
- 2
- 3
- 4
- 5
- 6
- 7
- 8
- 9
- 10
- 11

Type: UFH-LTV



Steel collector with A-pump and plate heat exchanger (low temperature)
 Stalen verdeler met A-pomp en scheidingswisselaar voor LT toepassing
 Collecteur en acier avec pompe label A et échangeur à plaques (temperature basse)
 Verteiler Stahl mit A-Pump und Plattenwärmetauscher (niedrigen Temperaturen)

Article number	Packing	Type	Subgroup
• UFH+0405LTV01	1 pc.	1/2" - 1 x 3/4"	
• UFH+0405LTV02	1 pc.	1/2" - 2 x 3/4"	
• UFH+0405LTV03	1 pc.	1/2" - 3 x 3/4"	
• UFH+0405LTV04	1 pc.	1/2" - 4 x 3/4"	
• UFH+0405LTV05	1 pc.	1/2" - 5 x 3/4"	
• UFH+0405LTV06	1 pc.	1/2" - 6 x 3/4"	
• UFH+0505LTV07	1 pc.	3/4" - 7 x 3/4"	
• UFH+0505LTV08	1 pc.	3/4" - 8 x 3/4"	
• UFH+0505LTV09	1 pc.	3/4" - 9 x 3/4"	
• UFH+0505LTV10	1 pc.	3/4" - 10 x 3/4"	
• UFH+0505LTV11	1 pc.	3/4" - 11 x 3/4"	
• UFH+0505LTV12	1 pc.	3/4" - 12 x 3/4"	

Type: UFH-TTBD2050



Temperature reducer return, 20 - 50°C, built in, closed
 Teruglooptemperatuurbegrenzer 20 - 50°C, inbouw, dicht
 Régulation température retour entre 20 - 50 °C, encastré, fermé
 Regelbox für raumtemperaturabhängige Regelung 20-50°C, Unterputz, geschlossen

Article number	Packing	Type	Subgroup
UFH+TTBD2050	1 pc.	20 - 50°C	

TILL EXHAUSTION OF STOCK

B. MANIFOLDS

Type: UFH-TTB2050



Temperature reducer return, 20 - 50°C, built in, open
 Teruglooptemperatuurbegrenzer 20 - 50°C, inbouw
 Régulation température retour entre 20 - 50 °C, encastré, ouvert
 Regelbox für raumtemperaturabhängige Regelung 20-50°C, Unterputz, offen

Article number	Packing	Type	Subgroup
UFH-TTB2050	1 pc.	20 - 50°C	

TILL EXHAUSTION OF STOCK

Type: UFH-TV0628



Thermostatic valve 6 - 28°C, built in
 Thermostaatventiel 6 - 28°C, inbouw
 Vanne thermostatique de température ambiante entre 6 - 28 °C, encastré
 Thermostatventil 6-28°C, Unterputz

Article number	Packing	Type	Subgroup
UFH-TV0628	1 pc.	6 - 28°C	

TILL EXHAUSTION OF STOCK

Type: UFH-MAXB55



Maximum temperature safety cut-out switch
 Maximaalbeveiligingsschakelaar
 Interrupteur de protection maximal
 Maximalschutzschalter

Article number	Packing	Type	Subgroup
UFH-MAXB55	1 pc.	Max. 55 °C	

TILL EXHAUSTION OF STOCK

Type: UFH-MAX95



Maximum temperature safety cut-out switch 50 - 95°C
 Maximaalthermostaat, 50 - 95°C
 Thermostat de sécurité, 50 - 95 °C
 Maximalschutzschalter, 50 - 95 °C

Article number	Packing	Type	Subgroup
UFH-MAX95	1 pc.	50 - 95°C- 15A/ 230V	

TILL EXHAUSTION OF STOCK

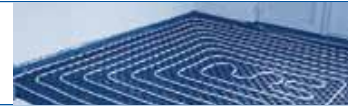

Type: UFH-ZONE-W



Control unit for 4 wired room thermostats, including pump relay, heating, 230V
 Regelunit voor 4 bedrade kamerthermostaten inclusief pompsturing, voor verwarming, 230V
 Régulation chauffage pour 4 thermostats avec □, contacte pompe inclus, chauffer, 230V
 Regelverteiler für 4 Raumthermostate mit Pumpensteuerung, nur heizen, 230V

Article number	Packing	Type	Subgroup
UFH-ZONE-W	1 pc.	ZONE-W230V	

Type: UFH-ZONE24V-W



Control unit for 4 wired room thermostats, including pump relay, heating, 24V
 Regelunit voor 4 bedrade kamerthermostaten inclusief pompsturing, voor verwarming, 24V
 Régulation chauffage pour 4 thermostats avec □, contacte pompe inclus, chauffer, 24V
 Regelverteiler für 4 Raumthermostate mit Pumpensteuerung, nur heizen, 24V

Article number	Packing	Type	Subgroup
UFH-ZONE24V-W	1 pc.	ZONE-W24V	

Type: UFH-ZONE-B



Control unit with clock, BUS-conn.&pump relay, heating, 230V
 Regelunit met klok, BUS-connectie & pompst, verwarmen 230V
 Unité de commande, conn. USB&commande pompe, chauffer, 230V
 Regelverteiler, USB Anschluss&Pumpensteuerung, heizen, 230V

Article number	Packing	Type	Subgroup
UFH-ZONE-B	1pc.	ZONE-B 230V	

TILL EXHAUSTION OF STOCK

Type: UFH-ZONEHC-B



Control unit with clock for 4 wired thermostats, incl. BUS-connection and pump relay, heating & cooling, 230V
 Regelunit met klok voor 4 bedrade kamerthermostaten, incl. BUS-aansluitdoos en pompsturing, voor verwarming en koeling, 230V
 Régulation chauffage avec minuterie pour 4 thermostats avec □, BUS-connexion et contacte pompe inclus, chauffer et refroidir, 230V
 Regelverteiler für 4 Raumthermostate, BUS-Anschluss und Pumpensteuerung inbegriffen, heizen/kühlen, 230V

Article number	Packing	Type	Subgroup
UFH-ZONEHC-B	1 pc.	ZONEHC-B 230V	

- 1
- 2
- 3
- 4
- 5
- 6
- 7
- 8
- 9
- 10
- 11

Type: UFH-ZONE-R



Control unit with clock for 6 wireless thermostats, incl. antenna and pump relay, heating, 230V
 Regelunit met klok voor 6 radiogestuurde thermostaten, incl. antenne en pomps-
 turing, voor verwarming, 230V
 Régulation chauffage avec minuterie pour 6 thermostats RF, antenne et contacte
 pompe inclus, chauffer, 230V
 Regelverteiler für Funk-Raumthermostate, Antenne und Pumpensteuerung inbe-
 griffen, nur heizen, 230V

Article number	Packing	Type	Subgroup
UFH-ZONE-R	1 pc.	ZONE-R230V	

Type: UFH-ZONEHC-R



Control unit with clock for 4 wireless thermostats, incl. antenna and pump relay, heating & cooling, 230V
 Regelunit met klok voor 4 radiogestuurde thermostaten, incl. antenne en pomps-
 turing, voor verwarming en koeling, 230V
 Régulation chauffage avec minuterie pour 4 thermostats RF, antenne et contacte
 pompe inclus, chauffer et refroidir, 230V
 Regelverteiler für Funk-Raumthermostate, Antenne und Pumpensteuerung inbe-
 griffen, heizen/kühlen, 230V

Article number	Packing	Type	Subgroup
UFH-ZONEHC-R	1 pc.	ZONEHC-R230V	

Type: UFH-TRANS230V24



Transformer 230V - 24V
 Transformator van 230V naar 24V
 Transformateur 230V - 24V
 Transformator 230V - 24V

Article number	Packing	Type	Subgroup
UFH-TRANS230V24	1 pc.	230V- 24V/ 60VA	

Type: UFH-EXTRAZONE-W



Extension module for 4 extra wired room thermostats, 230V (UFH-ZONE-W)
 Uitbreidingsmodule voor 4 extra bedrade kamerthermostaten, 230V
 (UFH-ZONE-W)
 Module d' extension pour 4 thermostats avec □, 230V (UFH-ZONE-W)
 Regelverteiler Erweiterung für 4 zusätzliche Raumthermostate, 230V
 (UFH-ZONE-W)

Article number	Packing	Type	Subgroup
UFH-EXTRAZONE-W	1 pc.	EXTRA-W230V	

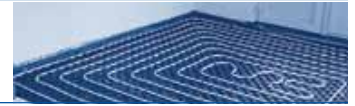

Type: UFH-EXTRAZ24V-W



Extension module for 4 extra wired room thermostats, 24V (UFH-ZONE24V-W)
 Uitbreidingsmodule voor 4 extra bedrade kamerthermostaten, 24V (UFH-ZONE24V-W)
 Module d' extension pour 4 thermostats avec □, 24V (UFH-ZONE24V-W)
 Regelverteiler Erweiterung für 4 zusätzliche Raumthermostate, 24V (UFH-ZONE24V-W)

Article number	Packing	Type	Subgroup
UFH-EXTRAZ24V-W	1 pc.	EXTRA-W24V	

- 1
- 2
- 3
- 4
- 5
- 6
- 7
- 8
- 9
- 10
- 11

Type: UFH-EXTRAZONE-R



Extension module for 4 extra wireless thermostats, 230V (UFH-ZONEHC-B / UFH-ZONEHC-R / UFH-ZONE-R)
 Uitbreidingsmodule voor 4 extra radiogestuurde thermostaten, 230V (UFH-ZONEHC-B / UFH-ZONEHC-R / UFH-ZONE-R)
 Module d' extension pour 4 thermostats RF, 230V (UFH-ZONEHC-B / UFH-ZONEHC-R / UFH-ZONE-R)
 Regelverteiler Erweiterung für 4 zusätzliche Funk-Raumthermostate, 230V (UFH-ZONEHC-B / UFH-ZONEHC-R / UFH-ZONE-R)

Article number	Packing	Type	Subgroup
UFH-EXTRAZONE-R	1 pc.	EXTRA-R230V	

Type: UFH-THERM-W



Wired room thermostat, 230V (UFH-ZONE-W)
 Kamerthermostaat, bedraad, 230V (UFH-ZONE-W)
 Thermostat avec □, 230V (UFH-ZONE-W)
 Raumthermostat, 230V (UFH-ZONE-W)

Article number	Packing	Type	Subgroup
UFH-THERM-W	1 pc.	Scale 1-5	

Type: UFH-THERM24V-W



Wired room thermostat, 24V (UFH-ZONE24V-W)
 Kamerthermostaat, bedraad, 24V (UFH-ZONE24V-W)
 Thermostat avec □, 24V (UFH-ZONE24V-W)
 Raumthermostat, 24V (UFH-ZONE24V-W)

Article number	Packing	Type	Subgroup
UFH-THERM24V-W	1 pc.	Scale 1-5	

Type: UFH-TIMER-W



Clock for control unit (UFH-ZONE-W / UFH-ZONE24V-W)
 Klok voor regelunit (UFH-ZONE-W / UFH-ZONE24V-W)
 Minuterie pour régulation de chauffage (UFH-ZONE-W / UFH-ZONE24V-W)
 Regelung für Regelverteiler (UFH-ZONE-W / UFH-ZONE24V-W)

Article number	Packing	Type	Subgroup
UFH-TIMER-W	1 pc.	TIMER-W	

Type: UFH-THERM-WD



Wired digital room thermostat, 230V (UFH-ZONE-W)
 Digitale kamerthermostaat, bedraad, 230V (UFH-ZONE-W)
 Thermostat digital avec □, 230V (UFH-ZONE-W)
 Raumthermostat mit Digitalanzeige, 230V (UFH-ZONE-W)

Article number	Packing	Type	Subgroup
UFH-THERM-WD	1 pc.	THERM-WD 230V	

Type: UFH-THERM24V-WD



Wired digital room thermostat, 24V (UFH-ZONE24V-W)
 Digitale kamerthermostaat, bedraad, 24V (UFH-ZONE24V-W)
 Thermostat digital avec □, 24V (UFH-ZONE24V-W)
 Raumthermostat mit Digitalanzeige, 24V (UFH-ZONE24V-W)

Article number	Packing	Type	Subgroup
UFH-THERM24V-WD	1 pc.	THERM-WD 24V	

Type: UFH-THERM-B



Wired room thermostat (UFH-ZONEHC-B)
 Kamerthermostaat, bedraad (UFH-ZONEHC-B)
 Thermostat avec □ (UFH-ZONEHC-B)
 Raumthermostat (UFH-ZONEHC-B)

Article number	Packing	Type	Subgroup
UFH-THERM-B	1 pc.	Scale 1-5	



Type: UFH-THERM-BD



Wired digital room thermostat (UFH-ZONEHC-B)
 Digitale kamerthermostaat, bedraad (UFH-ZONEHC-B)
 Thermostat digital avec \square (UFH-ZONEHC-B)
 Raumthermostat mit Digitalanzeige (UFH-ZONEHC-B)

Article number	Packing	Type	Subgroup
UFH-THERM-BD	1 pc.	THERM-BD	

- 1
- 2
- 3
- 4
- 5
- 6
- 7

Type: UFH-THERMHC-B



Wired room thermostat, master, heating & cooling (UFH-ZONEHC-B)
 Kamerthermostaat, bedraad, master, voor verwarmen en koelen (UFH-ZONEHC-B)
 Thermostat avec \square , maître, chauffer et refroidir (UFH-ZONEHC-B)
 Raumthermostat , master, heizen/kühlen (UFH-ZONEHC-B)

Article number	Packing	Type	Subgroup
UFH-THERMHC-B	1 pc.	THERMHC-B	

- 8
- 9
- 10
- 11

Type: UFH-THERMHC-BD



Wired digital room thermostat, master, heating & cooling (UFH-ZONEHC-B)
 Digitale kamerthermostaat, bedraad, master, voor verwarmen en koelen (UFH-ZONEHC-B)
 Thermostat digital avec \square , maître, chauffer et refroidir (UFH-ZONEHC-B)
 Raumthermostat mit Digitalanzeige, master, heizen/kühlen (UFH-ZONEHC-B)

Article number	Packing	Type	Subgroup
UFH-THERMHC-BD	1 pc.	THERMHC-BD	

Type: UFH-THERM-R



Wireless room thermostat (UFH-ZONEHC-R / UFH-ZONE-R)
 Radiogestuurde kamerthermostaat (UFH-ZONEHC-R / UFH-ZONE-R)
 Thermostat RF (UFH-ZONEHC-R / UFH-ZONE-R)
 Funk-Raumthermostat (UFH-ZONEHC-R / UFH-ZONE-R)

Article number	Packing	Type	Subgroup
UFH-THERM-R	1 pc.	Scale 1-5	

Type: UFH-THERM-RD



Wireless digital room thermostat (UFH-ZONEHC-R / UFH-ZONE-R)
 Radiogestuurde digitale kamerthermostaat (UFH-ZONEHC-R / UFH-ZONE-R)
 Thermostat RF, digital (UFH-ZONEHC-R / UFH-ZONE-R)
 Funk-Raumthermostat mit Digitalanzeige (UFH-ZONEHC-R / UFH-ZONE-R)

Article number	Packing	Type	Subgroup
UFH-THERM-RD	1 pc.	THERM-RD	

Type: UFH-KTR001



Wireless digital room thermostat programmable (UFH-ZONEHC-R / UFH-ZONE-R)
 Radiogestuurde digitale kamerthermostaat programmeerbaar (UFH-ZONEHC-R / UFH-ZONE-R)
 Thermostat d'ambiance sans \square , digital programmable (UFH-ZONEHC-R / UFH-ZONE-R)
 Funk-Raumthermostat mit Digitalanzeige programmierbar (UFH-ZONEHC-R / UFH-ZONE-R)

Article number	Packing	Type	Subgroup
UFH-KTR001	1 pc.	KTR001	

Type: UFH-THERMHC-R



Wireless room thermostat, master, heating & cooling (UFH-ZONEHC-R)
 Radiogestuurde kamerthermostaat, master, voor verwarmen en koelen (UFH-ZONEHC-R)
 Thermostat RF, maître, chauffeur et refroidir (UFH-ZONEHC-R)
 Funk-Raumthermostat, master, heizen/kühlen (UFH-ZONEHC-R)

Article number	Packing	Type	Subgroup
UFH-THERMHC-R	1 pc.	THERMHC-R	

Type: UFH-THERMHC-RD



Wireless digital room thermostat, master, heating & cooling (UFH-ZONEHC-R)
 Radiogestuurde digitale kamerthermostaat, master, voor verwarmen en koelen (UFH-ZONEHC-R)
 Thermostat digital RF, maître, chauffeur et refroidir (UFH-ZONEHC-R)
 Funk-Raumthermostat mit Digitalanzeige, master, heizen/kühlen (UFH-ZONEHC-R)

Article number	Packing	Type	Subgroup
UFH-THERMHC-RD	1 pc.	THERMHC-RD	

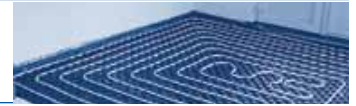

Type: UFH-ACT230 NC2



Thermal head actuator, 230V, normally closed (NC), M30x1,5
 Elektrothermische motor, 230V, stroomloos gesloten (NC), M30x1,5
 Moteur électrothermique, 230V, NF , M30x1,5
 Ventiltrieb, 230V, NC, M30x1,5

Article number	Packing	Type	Subgroup
UFH-ACT230NC2	1 pc.	230V, NC, M30x1,5	

Type: UFH-ACT24 NC2



Thermal head actuator, 24V, normally closed (NC), M30x1,5
 Elektrothermische motor, 24V, stroomloos gesloten (NC), M30x1,5
 Moteur électrothermique, 24V, NF , M30x1,5
 Ventiltrieb, 24V, NC, M30x1,5

Article number	Packing	Type	Subgroup
UFH-ACT24NC2	1 pc.	24V, NC, M30x1,5	

Type: UFH-ACT230 NC4



Thermal head actuator with auxiliary microswitch, 230V, normally closed (NC), M30x1,5
 Elektrothermische motor met hulpcontact, 230V, stroomloos gesloten (NC), M30x1,5
 Moteur électrothermique avec contact libre, 230V, NF, M30x1,5
 Ventiltrieb mit Hilfsschalter, 230V, NC, M30x1,5

Article number	Packing	Type	Subgroup
UFH-ACT230NC4	1 pc.	230V, NC, M30x1,5	

Type: UFH-SENSOR



Floor and condensation sensor (optional) (UFH-THERM(HC)-WD, UFH-THERM(HC)-RD and UFH-H5004
 Vloer- en condensvoeler (optioneel) voor UFH-THERM(HC)-WD, UFH-THERM(HC)-RD en UFH-H5004
 Sonde de sol ou de condensation (optionelle) pour UFH-THERM(HC)-WD, UFH-THERM(HC)-RD et UFH-H5004
 Fussbodensensor oder Vorlaufsensor, (optional) für UFH-THERM(HC)-WD, UFH-THERM(HC)-RD und UFH-H5004

Article number	Packing	Type	Subgroup
UFH-SENSOR	1 pc.	3000 mm	

- 1
- 2
- 3
- 4
- 5
- 6
- 7
- 8
- 9
- 10
- 11

Type: UFH-H5004



Copper shroud for UFH-SENSOR
 Koperen huls voor UFH-SENSOR
 Doigt de gant pour UFH-SENSOR
 Kupferhulse für UFH-SENSOR

Article number	Packing	Type	Subgroup
UFH-H5004	1 pc.	50 mmx 1/2"	

Type: UFH-ANC



Valve
 Zoneventiel
 Vanne
 Ventil

Article number	Packing	Type	Subgroup
UFH-ANC-05	1 pc.	2 x 3/4" - M30x1,5 - Kv2	
UFH-ANC-06	1 pc.	2 x 1" - M30x1,5 - Kv4,5	

Type: UFH-ICE-R



Ice and snow indicator, control unit with sensor
 Ijs- en sneeuwmelder, regeling met voeler
 Protection hors gel, regulation avec sonde
 Eis- und Schneemelder, Regelung mit Fühler

Article number	Packing	Type	Subgroup
UFH-ICE-R	1 Set	88 x 107 x 60 mm	



Type: UFH-C191645



Thermostatic sensor 10/60°C with short probe
 Thermostaat voeler 10/60°C met korte sensor
 Tête thermostatique 10/60°C avec senseur court
 Thermostat 10/60°C mit kürze Fühler

Article number	Packing	Type	Subgroup
• UFH-C191645			

- 1
- 2
- 3
- 4
- 5
- 6
- 7
- 8
- 9
- 10
- 11

Type: UFH-C191902



Circulator Wilo RS 25/5-3 KU PL 130mm
 Circulator Wilo RS 25/5-3 KU PL 130mm
 Circulateur Wilo RS 25/5-3 KU PL 130mm
 Cirkulator Wilo RS 25/5-3 KU PL 130mm

Article number	Packing	Type	Subgroup
• UFH-C191902			

Type: UFH-C191974 - 76



Circulator Wilo Yonos Para RS 15/6-RKA KU 130mm
 Circulator Wilo Yonos Para RS 15/6-RKA KU 130mm
 Circulateur Wilo Yonos Para RS 15/6-RKA KU 130mm
 Cirkulator Wilo Yonos Para RS 15/6-RKA KU 130mm

Article number	Packing	Type	Subgroup
• UFH-C191974		1"	
• UFH-C191976		1,1/2"	

Type: UFH-C192071



Safety thermostat incl. wire/plug
 Maximaal thermostaat incl. snoer/stekker
 Thermostat de sécurité incl. □/prise
 Maximal Thermostat incl. Snur/Stecker

Article number	Packing	Type	Subgroup
• UFH-C192071	1 pc.		



Type: UFH-C191800



Thermometer with immersion sleeve 0/60 gr.
Thermometer met dompelbuis temp 0/60 gr.
Thermomètre temp. 0/60 gr. avec bulbe
Thermometer mit Tauchhülse 0/60 gr.

Article number	Packing	Type	Subgroup
UFH-C191800	1 pc.		

- 1
- 2
- 3
- 4
- 5
- 6
- 7
- 8**
- 9
- 10
- 11

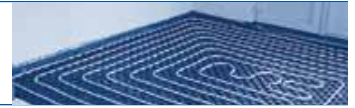

WIRED c ONTROL UNIT 24V
 BEKABELDE ZONEREGELING 24V
 RÉGULATEURS DE ZONE c ABLÉS 24V
 REGELVERTEILER VERDRAHTET 24V

- 1
- 2
- 3
- 4
- 5
- 6
- 7
- 8
- 9
- 10
- 11

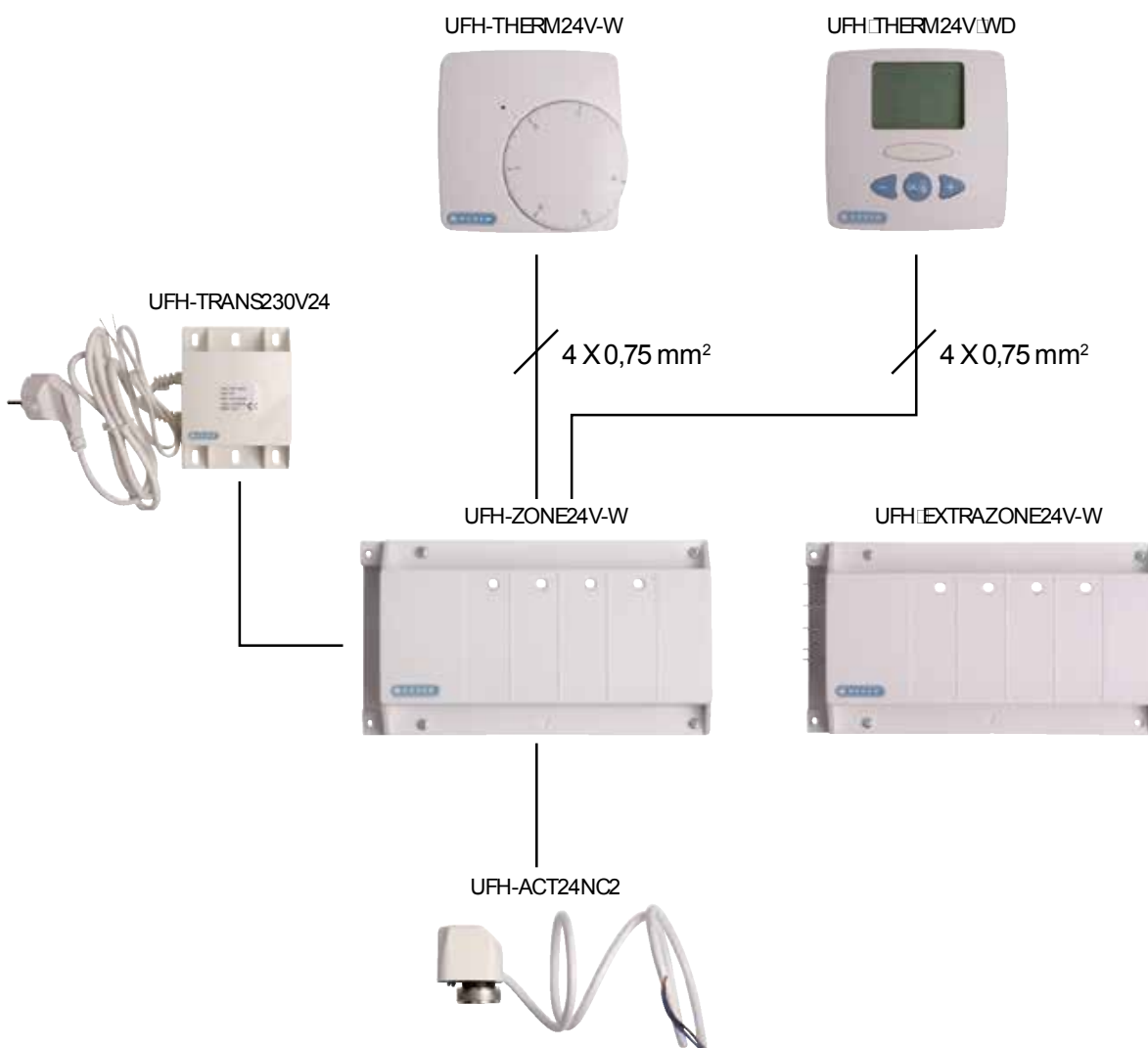



c . c ONTROL UNITS

- 1 WIRED c ONTROL UNIT (HEATING / c OOLING)
- 2 BEKABELDE ZONEREGELING (VERWARMEN / k OELEN)
- 3 RÉGULATEURS DE ZONE c ÂBLÉS (c HAUFFAGE / REFROIDISSEMENT)
- 4
- 5
- 6
- 7
- 8
- 9
- 10
- 11

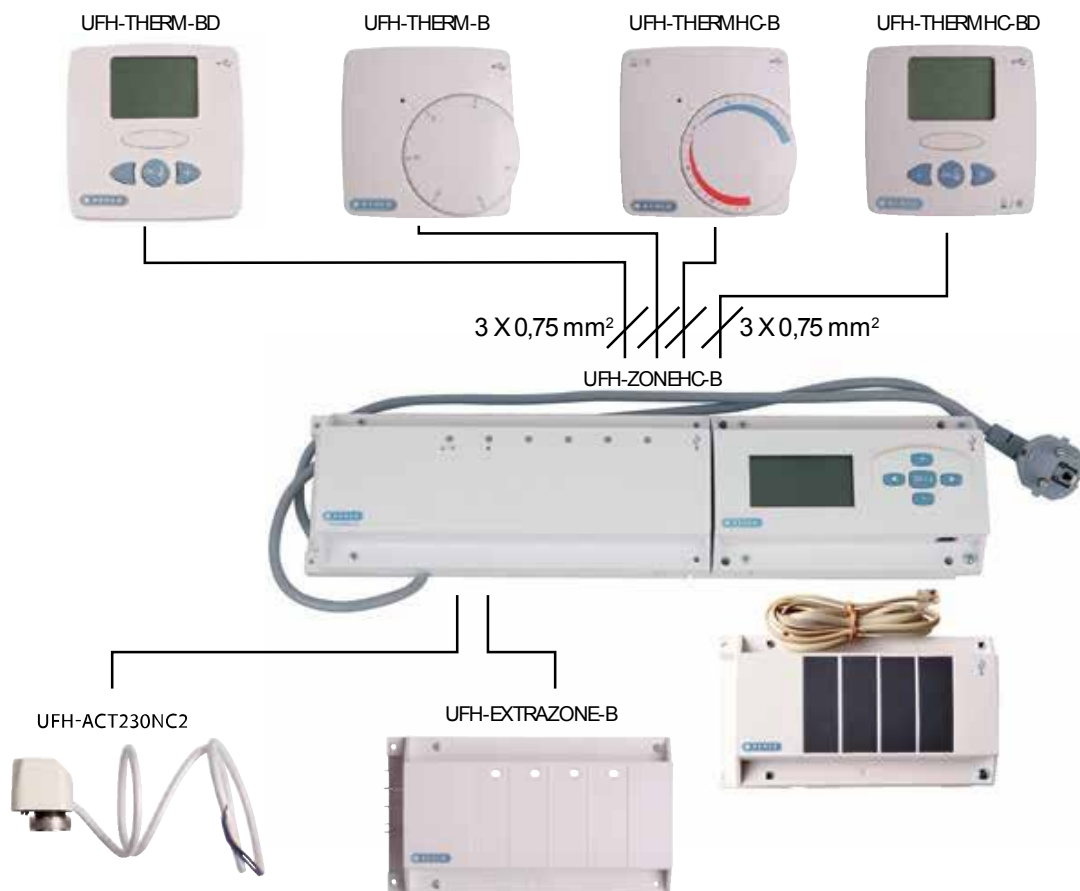

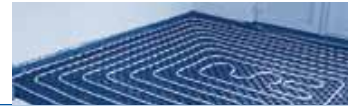

WIRELESS cONTROL UNIT (HEATING)
DRAADLOZE ZONEREGELING (VERWARMEN)
RÉGULATEURS DE ZONE SANS FIL (cHAUFFAGE)
REGELVERTEILER FUNK (HEIZEN)

- 1
- 2
- 3
- 4
- 5
- 6
- 7
- 8**
- 9
- 10
- 11

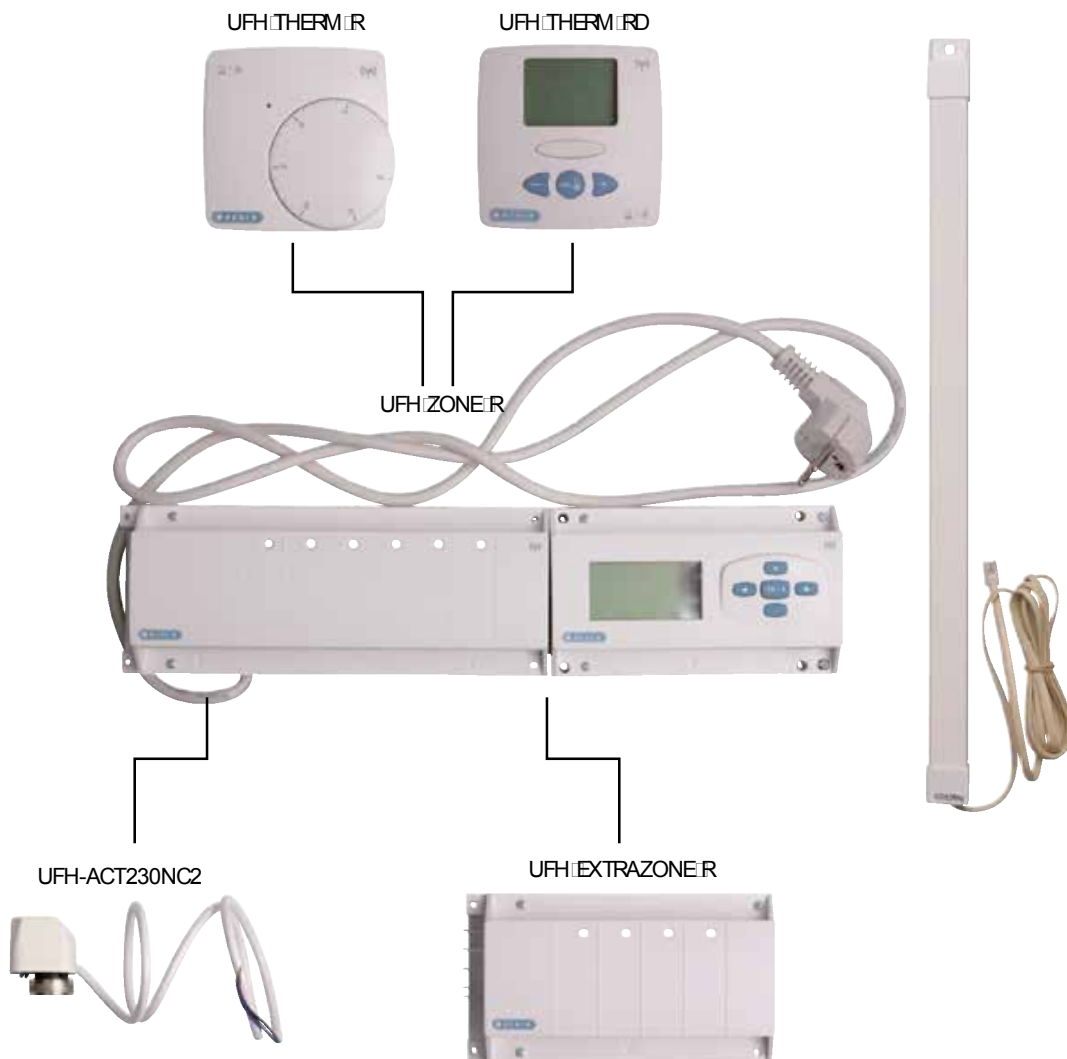

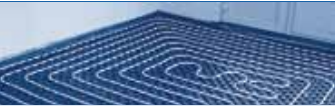

c . c ONTROL UNITS

- 1 WIRELESS c ONTROL UNIT (HEATING / c OOLING)
- 2 DRAADLOZE ZONEREGELING (VERWARMEN / KOELEN)
- 3 RÉGULATEURS DE ZONE SANS FIL (c HAUFFAGE / REFROIDISSEMENT)
- 4
- 5
- 6
- 7
- 8
- 9
- 10
- 11

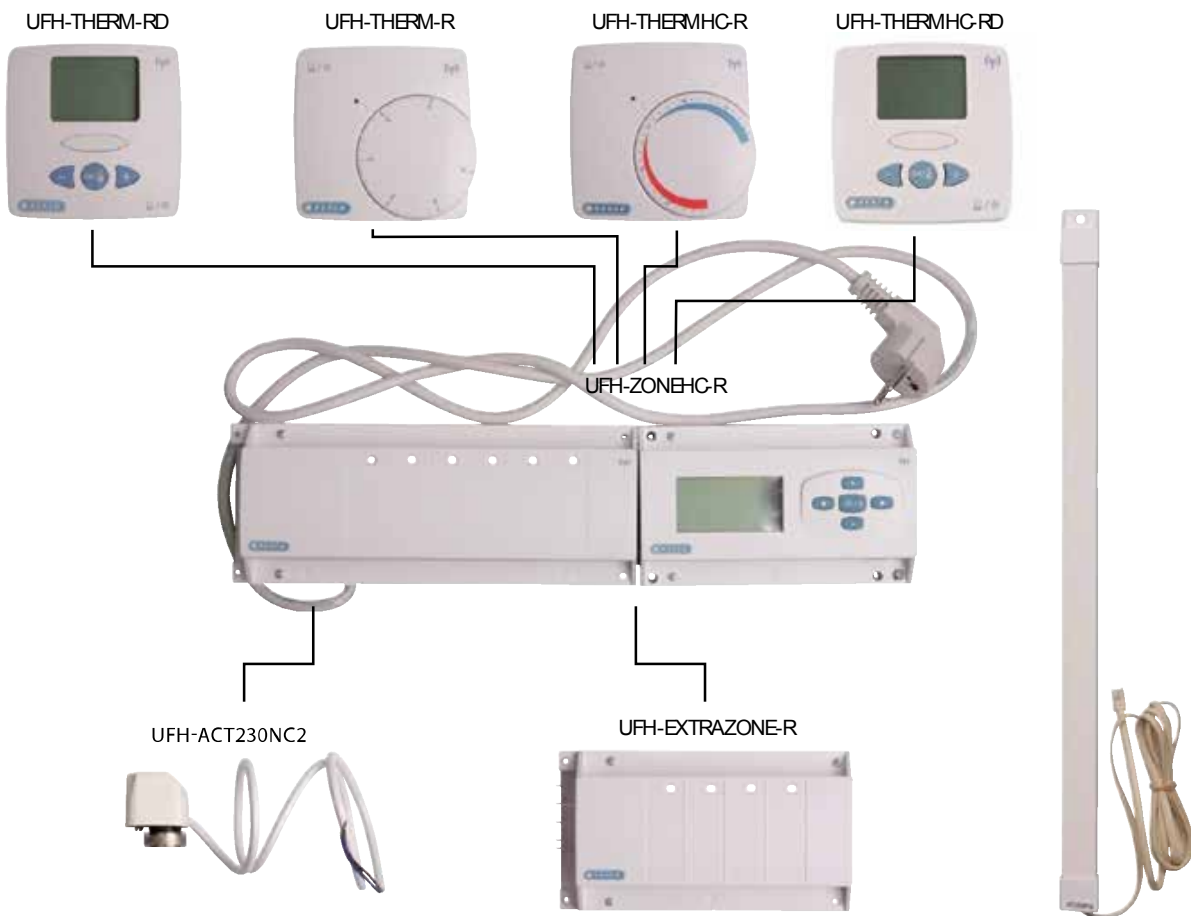



Type: UFH-GB



Hencologique basket type 1
 Hencologische korf type 1
 Panier hencologique type 1
 Hencologische Basket Type 1

Article number	Packing	Type	Subgroup
UFH-GB26100	1 pc.	110cm x 200cm	

Type: UFH-CDGEO



Manifold composite GEO, adjustable with flowmeter
 Composiet verdeler GEO, regelbaar met debietmeting
 Collecteur composite GEO, réglable avec débitmètre
 Verteiler Composite GEO, regelbar mit Durchflüssenmengenähler

Article number	Packing	Type	Subgroup
UFH+0626CD01	1 pc.	1" - 1 x Ø26	
UFH+0626CD02	1 pc.	1" - 2 x Ø26	
UFH+0626CD03	1 pc.	1" - 3 x Ø26	
UFH+0626CD04	1 pc.	1" - 4 x Ø26	
UFH+0626CD05	1 pc.	1" - 5 x Ø26	
UFH+0626CD06	1 pc.	1" - 6 x Ø26	
UFH+0626CD07	1 pc.	1" - 7 x Ø26	
UFH+0626CD08	1 pc.	1" - 8 x Ø26	





Type: UFH-CAB-I



Recessed manifold cabinet, RAL 9016
 Verdelerkast voor inbouw, RAL 9016
 Boîte à encastrer pour collecteurs, RAL 9016
 Verteilerschrank Unterputz, RAL 9016

Article number	Packing	Type	Subgroup
UFH-CAB-I400 *	1 pc.	400x700-800x112-152mm (4 circ.)	
UFH-CAB-I600 *	1 pc.	600x700-800x112-152mm (8 circ.)	
UFH-CAB-I800 *	1 pc.	800x700-800x112-152mm (12 circ.)	
UFH-CAB-I1000 *	1 pc.	1000x700-800x112-152mm (16 circ.)	

* Only in combination with brass manifolds

Type: UFH-CAB-O



Surface mount manifold cabinet, RAL 9016
 Verdelerkast voor opbouw, RAL 9016
 Boîte à poser pour collecteurs, RAL 9016
 Verteilerschrank Aufputz, RAL 9016

Article number	Packing	Type	Subgroup
UFH-CAB-O400 *	1 pc.	400x720x112mm (4 circ.)	
UFH-CAB-O600 *	1 pc.	600x720x112mm (8 circ.)	
UFH-CAB-O800 *	1 pc.	800x720x112mm (12 circ.)	
UFH-CAB-O1000 *	1 pc.	1000x720x112mm (16 circ.)	

* Only in combination with brass manifolds

- 1
- 2
- 3
- 4
- 5
- 6
- 7
- 8
- 9
- 10
- 11



Press machines, press jaws and calibrating tools should be checked on a regular base when used intensively.

Persmachines, persbekken en kalibreergereedschap dienen bij intensief gebruik op regelmatige basis gecontroleerd te worden.

Des machines à sertir, des pinces et des outils pour calibrage soumis à un usage intensif doivent être contrôlé régulièrement.

Press Maschinen, Pressbacken und Kalibrierung Werkzeuge sollten auf einer regelmäßigen Basis überprüft werden, wenn intensiv genutzt.



Type: BI



Internal bending spring
 Binnenbuigveer
 Ressort à plier intérieur
 Biegefeder innen

Article number	pc / Box	Type	Subgroup
BI-1410	1 pc. / 100 pc.	14x2 L=50 cm	
BI-1612	1 pc. / 100 pc.	16x2 L=50 cm	
BI-1612L	1 pc. / 50 pc.	16x2 L=100 cm	
BI-1814	1 pc. / 75 pc.	18x2 L=50 cm	
BI-2016	1 pc. / 75 pc.	20x2 L=50 cm	
BI-2016L	1 pc. / 25 pc.	20x2 L=100 cm	
BI-2620	1 pc. / 25 pc.	26x3 L=100 cm	

- 1
- 2
- 3
- 4
- 5
- 6
- 7
- 8
- 9
- 10
- 11

Type: BA



External bending spring
 Buitenbuigveer
 Ressort à plier extérieur
 Biegefeder aussen

Article number	pc / Box	Type	Subgroup
BA-1288	1 pc. / 50 pc.	12x1,88 L=50 cm	
BA-1410	1 pc. / 50 pc.	14x2 L=50 cm	
BA-1612	1 pc. / 50 pc.	16x2 L=50 cm	
BA-1814	1 pc. / 50 pc.	18x2 L=50 cm	
BA-2016	1 pc. / 50 pc.	20x2 L=50 cm	

Type: BM



Bending tool
 Buigijzer
 Cintreuse
 Biegewaterkzeug

Article number	Packing	Type	Subgroup
BM-16	1 pc.	for Ø16	
BM-20	1 pc.	for Ø20	

Type: BM



Bending tool 26mm
 Buigijzer 26mm
 Cintreuse 26mm
 Biegewaterkzeug 26mm

Article number	Packing	Type	Subgroup
BM-26	1 pc.	for Ø26	



Type: RSPRESS



Guillotine cutter
 Guillotineschaar
 Pince guillotine
 Guillotinezange

Article number	Packing	Type	Subgroup
RS1420PRESS	1 pc.	14 till 20 mm	
RS2640PRESS	1 pc.	26 till 40 mm	

Type: RSEM-PERS



Replacement blade for art. RS1420PRESS and RS2640PRESS
 Vervangmes voor art. RS1420PRESS en RS2640PRESS
 Lame pour art. RS1420PRESS et RS2640PRESS
 Ersatzmesser für Art. RS1420PRESS UND RS2640PRESS

Article number	Packing	Type	Subgroup
RSEM1420-PERS	1 pc.	14 till 20 mm	
RSEM2640-PERS	1 pc.	26 till 40 mm	

Type: RSPRESS-N



Guillotine cutter
 Guillotineschaar
 Pince guillotine
 Guillotinezange

Article number	Packing	Type	Subgroup
RS1420PRESS-N	1 pc.	14 till 20 mm	

Type: RS



Wheel cutter
 Buizensnijder
 Coupe-tube
 Rohrschneidezange

Article number	Packing	Type	Subgroup
RS32	1 pc.	14 till 32 mm	
RS63	1 pc.	14 till 63 mm	



Type: RSEM



Replacement wheel for art. RS32 and RS63
 Vervangmes voor art. RS32 en RS63
 Lame de rechange pour art. RS32 et RS63
 Ersatzmesser für Art. RS32 und RS63

Article number	Packing	Type	Subgroup
RSEM32	1 pc.	14 till 32 mm	
RSEM63	1 pc.	14 till 63 mm	

- 1
- 2
- 3
- 4
- 5
- 6
- 7
- 8
- 9
- 10
- 11

Type: RS1435F



Pipe cutter
 Snijschaar
 Coupe-tube pistolet
 Rohrschneidezange

Article number	pc / Box	Type	Subgroup
RS1435F	1 pc. / 20 pc.	14 till 20 mm	

TILL EXHAUSTION OF STOCK

Type: RSEM1435F



Replacement blade for art. RS1435F
 Vervangmes voor art. RS1435F
 Lame de rechange pour art. RS1435F
 Ersatzmesser für Art. RS1435F

Article number	Packing	Type	Subgroup
RSEM1435F	1 pc.	14 till 20 mm	

TILL EXHAUSTION OF STOCK

Type: SAFECUT



Cutter to open the packing paper
 Mes om verpakkingspapier te openen
 Couteau pour ouvrir le papier d'emballage
 Schneider zum Öffnen der Packing

Article number	Packing	Type	Subgroup
SAFECUT	1 pc.	SAFECUT	

- 1
- 2
- 3
- 4
- 5
- 6
- 7
- 8
- 9
- 10
- 11

Type: KS-MSET1



Set with KS-K and KS-M for Ø16, 20 and 26
 Set met KS-K en KS-M voor Ø16, 20 en 26
 Set avec KS-K et KS-M pour Ø16, 20 et 26
 Set mit KS-K und KS-M für Ø16, 20 und 26

Article number	Packing	Type	Subgroup
KS-MSET1	1 pc.	MSET1	

Type: KS-MSET2



Set with KS-K and KS-M for Ø14, 16, 18, 20, 26, 32 and 40
 Set met KS-K en KS-M voor Ø14, 16, 18, 20, 26, 32 en 40
 Set avec KS-K et KS-M pour Ø14, 16, 18, 20, 26, 32 et 40
 Set mit KS-K und KS-M für Ø14, 16, 18, 20, 26, 32 und 40

Article number	Packing	Type	Subgroup
KS-MSET2	1 pc.	MSET2	

Type: KS



Kalispeed for electric drills (max. 500 rpm, clockwise only)
 Kalispeed voor accu-boormachine (max. 500 toeren, rechts draaien verplicht)
 Kalispeed pour perceuses à batterie (max. 500 tournages, obligation de tourner à droite)
 Kalispeed für Akku-Bohrmaschine (max. 500 Drehungen, rechts drehen verpflichtet)

Article number	Packing	Type	Subgroup
KS50	1 pc.	for Ø50	
KS63	1 pc.	for Ø63	

Type: KS-M



Kalispeed, metal, for KS-K and electric drills (max. 500 rpm, clockwise only)
 Kalispeed, metaal, voor KS-K en accu-boormachine (max. 500 toeren, rechts draaien verplicht)
 Kalispeed, métal, pour KS-K et perceuses à batterie (max. 500 tours, obligation de tourner à droite)
 Kalispeed, Metall, für KS-K und Akku-Bohrmaschine (max. 500 Drehungen, rechts drehen verpflichtet)

Article number	Packing	Type	Subgroup
KS12M	1 pc.	for Ø12	
KS14M	1 pc.	for Ø14	
KS16M	1 pc.	for Ø16	
KS18M	1 pc.	for Ø18	
KS20M	1 pc.	for Ø20	
KS26M	1 pc.	for Ø26	
KS32M	1 pc.	for Ø32	
KS40M	1 pc.	for Ø40	



Type: KS-K



Clickhandle for KS (Kalispeed)
 Klikhandvat voor KS (Kalispeed)
 Manche clic pour KS (Kalispeed)
 Klickgriff für KS (Kalispeed)

Article number	Packing	Type	Subgroup
KS-K	1 pc.	up to Ø26 mm	

- 1
- 2
- 3
- 4
- 5
- 6
- 7
- 8
- 9
- 10
- 11

Type: KS-P



Kalispeed for Ø16, 20 and 26
 Kalispeed voor Ø16, 20 en 26
 Kalispeed pour Ø16, 20 et 26
 Kalispeed für Ø16, 20 und 26

Article number	Packing	Type	Subgroup
KS-P162026	1 pc.	for Ø16, 20 and 26	

Not for intensive use

Type: M-BA00



Kit: battery press machine including battery + charge unit + case, linear drive 32 to 40 kN
 Kit: accu-persmachine + accu + lader + koffer, lineaire aandrijving 32 tot 40 kN
 Kit: machine à sertir + batterie + chargeur + coffret, propulsion linéaire 32 jusqu'à 40 kN
 Kit: Akku-Pressmaschine, lineare Schubkraft 32 bis 40 kN

Article number	Packing	Type	Subgroup
M-BA00	1 pc.	BA00	

Type: M-BAT



Battery for M-BA00
 Accu voor M-BA00
 Batterie pour M-BA00
 Akku für M-BA00

Article number	Packing	Type	Subgroup
M-BAT	1 pc.	BAT	

Type: M-LAD



Charge-unit for M-BA00 and M-BMINI
 Lader voor M-BA00 en M-BMINI
 Chargeur pour M-BA00 et M-BMINI
 Akku-Ladegerät für M-BA00 und M-BMINI

Article number	Packing	Type	Subgroup
M-LAD	1 pc.	LAD	



Type: M-TRANS



Mains Adapter for M-BA00 (cord length: 4m)
 Adapter voor netaansluiting M-BA00 (snoer: 4m)
 Adapteur raccordement au réseau M-BA00 (câble: 4m)
 Netzadapter für M-BA00 (Kabellänge:4m)

Article number	Packing	Type	Subgroup
M-TRANS	1 pc.	TRANS	

Type: M-BHY162026



Kit : 230 volt hydraulic press machine with 16, 20, 26 jaws + metal case (110 volt also available), linear drive 32 to 40 kN
 Kit : Elektrisch-hydraulische persmachine + bekken 16, 20, 26 + koffer, lineaire aandrijving 32 tot 40kN
 Kit: machine à sertir électro-hydraulique + pinces 16, 20, 26 + coffret, propulsion linéaire 32 jusqu'à 40 kN
 Kit : Elektrohydraulische Pressmaschine + Pressbacken 16, 20, 26 + Koffer, lineare Schubkraft 32 bis 40 kN

Article number	Packing	Type	Subgroup
M-BHY162026	1 pc.	Ø14-63	

Type: M-BHY



Kit : 230 volt hydraulic press machine + metal case (110 volt also available), linear drive 32 to 40 kN
 Kit : Elektrisch-hydraulische persmachine + koffer, lineaire aandrijving 32 tot 40kN
 Kit: machine à sertir électro-hydraulique + coffret, propulsion linéaire 32 jusqu'à 40 kN
 Kit : Elektrohydraulische Pressmaschine + Koffer, lineare Schubkraft 32 bis 40 kN

Article number	Packing	Type	Subgroup
M-BHY	1 pc.	Ø14-63	

Type: M-BOXBHY



Metal case for M-BHY162026
 Koffer voor M-BHY162026
 Coffret en métal pour M-BHY162026
 Koffer für M-BHY162026

Article number	Packing	Type	Subgroup
M-BOXBHY	1 pc.	Ø14-63	



Type: BE



Jaws
 Persbekken
 Pincas à sertir
 Pressbacken

Article number	Packing	Type	Subgroup
BE14	1 pc.	BE 14x2	
BE16	1 pc.	BE 16x2	
BE18	1 pc.	BE 18x2	
BE20	1 pc.	BE 20x2	
BE26	1 pc.	BE 26x3	
BE32	1 pc.	BE 32x3	
BE40	1 pc.	BE 40x3,5	
BE50	1 pc.	BE 50x4	
BE63	1 pc.	BE 63x4,5	

1

2

3

4

5

6

7

8

9

10

11

Type: BE-UNISSET1



Set with jaw mounting unit and BE-H inserts Ø16, 20 and 26
 Set met moederbek en wisselbekken BE-H Ø16, 20, 26
 Set avec pince mère et pincas BE-H Ø16, 20, 26
 Set mit Mutterpressbacke und Backen BE-H Ø16, 20, 26

Article number	Packing	Type	Subgroup
BE-UNSET1	1 pc.	UNSET1	

Press tool compatibility: see technical manual

Type: BE-UNISSET2



Set with jaw mounting unit and BE-H inserts Ø14, 16, 18, 20, 26, and 32
 Set met moederbek en wisselbekken BE-H Ø14, 16, 18, 20, 26 en 32
 Set avec pince mère et pincas BE-H Ø14, 16, 18, 20, 26, et 32
 Set mit Mutterpressbacke und Backen BE-H Ø14, 16, 18, 20, 26, und 32

Article number	Packing	Type	Subgroup
BE-UNSET2	1 pc.	UNSET2	

Press tool compatibility: see technical manual

- 1
- 2
- 3
- 4
- 5
- 6
- 7
- 8
- 9
- 10
- 11

Type: TOOLBOX16202632



Box with KS16 20 26 32 M, BE-UNI, BE16 20 26 32 H, BI-1612, BI-2016, BA-1612, BA-2016, RS1420PRESS, SAFECUT
 Koffer met KS16 20 26 32 M, BE-UNI, BE16 20 26 32 H, BI-1612, BI-2016, BA-1612, BA-2016, RS1420PRESS, SAFECUT
 Coffre avec KS16 20 26 32 M, BE-UNI, BE16 20 26 32 H, BI-1612, BI-2016, BA-1612, BA-2016, RS1420PRESS, SAFECUT
 Koffer mit KS16 20 26 32 M, BE-UNI, BE16 20 26 32 H, BI-1612, BI-2016, BA-1612, BA-2016, RS1420PRESS, SAFECUT

Article number	Packing	Type	Subgroup
TOOLBOX16202632	1 pc.	TOOLBOX16202632	

Type: TOOLBOX405063



Box with KS40M, KS50, KS63, BE40 50 63, RS63
 Koffer met KS40M, KS50, KS63, BE40 50 63, RS63
 Coffre avec KS40M, KS50, KS63, BE40 50 63, RS63
 Koffer mit KS40M, KS50, KS63, BE40 50 63, RS63

Article number	Packing	Type	Subgroup
TOOLBOX405063	1 pc.	TOOLBOX405063	

Type: BE-UNI



Jaw mounting unit for M-BA00 and M-BHY, to be used with BE-H jaws
 Moederbek voor M-BA00 en M-BHY en te gebruiken met BE-H bekken
 Pince mère pour M-BA00 et M-BHY, à utiliser avec pinces BE-H
 Mutterpressbacke für M-BA00 und M-BHY, zu verwenden mit BE-H Backen

Article number	Packing	Type	Subgroup
BE-UNI	1 pc.	BE-UNI	

Press tool compatibility: see technical manual

BE-UNI is designed to press Henco press fittings, the interchangeable dies with M- and V-profile make it possible to make the transition from other materials to Henco; other than Henco branded fittings with compact measurements can cause complex manipulation.



Type: BE-H



Inserts for BE-UNI, BE-MINI, M-BH
 Wisselbekken voor BE-UNI, BE-MINI, M-BH
 Pincas pour BE-UNI, BE-MINI, M-BH
 Pressbacken für BE-UNI, BE-MINI, M-BH

Article number	Packing	Type	Subgroup
BE14H	1 Set (2 pc.)	BE 14X2 H	
BE16H	1 Set (2 pc.)	BE 16X2 H	
BE18H	1 Set (2 pc.)	BE 18X2 H	
BE20H	1 Set (2 pc.)	BE 20X2 H	
BE26H	1 Set (2 pc.)	BE 26X3 H	
BE32H	1 Set (2 pc.)	BE 32X3 H	

Type: BE-HC



Inserts (copper) for BE-UNI, BE-MINI, M-BH
 Wisselbekken (koper) voor BE-UNI, BE-MINI, M-BH
 Pincas (cuivre) pour BE-UNI, BE-MINI, M-BH
 Pressbacken (Kupfer) für BE-UNI, BE-MINI, M-BH

Article number	Packing	Type	Subgroup
BE12HC	1 Set (2 pc.)	12Qu V-pro:le	
BE15HC	1 Set (2 pc.)	15Qu V-pro:le	
BE22HC	1 Set (2 pc.)	22Qu V-pro:le	
BE28HC	1 Set (2 pc.)	28Qu V-pro:le	

Type: BE-HM



Inserts (copper) for BE-UNI, BE-MINI, M-BH
 Wisselbekken (koper) voor BE-UNI, BE-MINI, M-BH
 Pincas (cuivre) pour BE-UNI, BE-MINI, M-BH
 Pressbacken (Kupfer) für BE-UNI, BE-MINI, M-BH

Article number	Packing	Type	Subgroup
BE12HM	1 Set (2 pc.)	12Qu M-pro:le	
BE15HM	1 Set (2 pc.)	15Qu M-pro:le	
BE22HM	1 Set (2 pc.)	22Qu M-pro:le	

Type: BE-BOX



Metal case for 4 compression jaws
 Stalen koffer voor 4 persbekken
 Coffret en métal pour 4 pincas à sertir
 Stahlblechkasten für 4 Pressbacken

Article number	Packing	Type	Subgroup
BE-BOX	1 pc.	BOX	

- 1
- 2
- 3
- 4
- 5
- 6
- 7
- 8
- 9
- 10
- 11



Type: M-BMINI2



Kit : compact rechargable battery press machine with press monitoring + case + charge unit + battery 18V/ 1,5 Ah Li-ion, jaw and interchangeable dies Ø16, 20, 26 (type BE-H), linear drive ca. 15 kN

Kit: hydraulische accu-persmachine met persbewaking + kunststofkoffer + lader + 1 accu 18V/ 1,5 Ah Li-ion, moederbek en wisselbekken Ø16, 20 en 26 (type BE-H), lineaire aandrijving ca. 15kN

Kit : machine à sertir hydraulique + boîte en plastique + chargeur + batterie 18V / 1,5 Ah Li-ion, pince mère et pinces Ø16, 20, 26 (type BE-H), propulsion linéaire ca.15 kN

Kit: Hydraulisches Akku-Presswerkzeug mit Pressdrucküberwachung + Kunststoff-offkoffer + Ladegerät + 1 Akku 18V/ 1,5 Ah Li-ion, Mutterpressbacke und Pressbacken Ø16, 20 und 26 (type BE-H), lineare Schubkraft ca. 15 kN

Article number	Packing	Type	Subgroup
M-BMIN2	1 pc.	Ø14-32, 18V/ 1,5 Ah Li-ion	

Type: M-BMINI2-S



Kit : compact rechargable battery press machine with press monitoring + case + charge unit + battery 18V/ 1,5 Ah Li-ion, linear drive ca. 15 kN

Kit: hydraulische accu-persmachine met persbewaking + kunststofkoffer + lader + 1 accu 18V/ 1,5 Ah Li-ion, lineaire aandrijving ca. 15kN

Kit : machine à sertir hydraulique + boîte en plastique + chargeur + batterie 18V / 1,5 Ah Li-ion, propulsion linéaire ca.15 kN

Kit: Hydraulisches Akku-Presswerkzeug mit Pressdrucküberwachung + Kunststoff-offkoffer + Ladegerät + 1 Akku 18V/ 1,5 Ah Li-ion, lineare Schubkraft ca. 15 kN

Article number	Packing	Type	Subgroup
M-BMIN2-S	1 pc.	Ø14-32, 18V/ 1,5 Ah Li-ion	

Type: M-BMINI2-SLB



Kit : compact rechargable battery press machine with press monitoring + case, linear drive ca. 15 kN

Kit: hydraulische accu-persmachine met persbewaking + kunststofkoffer, lineaire aandrijving ca. 15kN

Kit : machine à sertir hydraulique + boîte en plastique, propulsion linéaire ca.15 kN

Kit: Hydraulisches Akku-Presswerkzeug mit Pressdrucküberwachung + Kunststoff-offkoffer, lineare Schubkraft ca. 15 kN

Article number	Packing	Type	Subgroup
M-BMIN2-SLB	1 pc.	Ø14-32, 18V/ 1,5 Ah Li-ion	



Type: M-BATMINI2



Battery 18V / 1,5 Ah Li-ion for M-BMINI2
 Accu 18V / 1,5 Ah Li-ion voor M-BMINI2
 Batterie 18V / 1,5 Ah Li-ion pour M-BMINI2
 Akku 18V / 1,5 Ah Li-ion für M-BMINI2

Article number	Packing	Typ	Subgroup
M-BATMIN2	1 pc.	18V/ 1,5 Ah Li-ion	

- 1
- 2
- 3
- 4
- 5
- 6
- 7
- 8
- 9
- 10
- 11

Type: M-LADMINI2



Charge-unit for M-BMINI2(-S)
 Lader voor M-BMINI2(-S)
 Chargeur pour M-BMINI2(-S)
 Akku-Ladegerät für M-BMINI2(-S)

Article number	Packing	Type	Subgroup
M-LADMIN2	1 pc.	for M-BATMIN2	

Type: M-TRANSMINI2



Mains Adapter for M-BMINI2(S)
 Adapter voor netaansluiting M-BMINI2(-S)
 Adapteur raccordement au réseau M-BMINI2(-S)
 Netzadapter für M-BMINI2(-S)

Article number	Packing	Type	Subgroup
M-TRANSMIN2	1 pc.	18V/ 230V	

Type: M-BOXMINI2



Case for M-BMINI2(-S)
 Koffer voor M-BMINI2(-S)
 Coffret pour M-BMINI2(-S)
 Koffer für M-BMINI2(-S)

Article number	Packing	Type	Subgroup
M-BOXMIN2	1 pc.	M-BOXMIN2	



Type: M-BMINI



Kit : compact rechargeable battery press machine + case + charge unit + battery 9,6 V, jaw and interchangeable dies Ø16, 20, 26 (type BE-H), linear drive ca. 15 kN

Kit : hydraulische accu-persmachine + kunststofkoffer + lader + 1 accu 9,6 V, moederbek en wisselbekken Ø16, 20, 26 (type BE-H), lineaire aandrijving ca. 15kN

Kit : machine à sertir hydraulique + boîte en plastique + chargeur + batterie 9,6 V, pince mère et pinces Ø16, 20, 26 (type BE-H), propulsion linéaire ca.15 kN

Kit : Hydraulisches Akku-Presswerkzeug + Kunststoffkoffer + Ladegerät + 1 Akku 9,6 V mit Mutterpressbacke und Pressbacken Ø16, 20, 26 (Type BE-H), lineare Schubkraft ca. 15 kN

Article number	Packing	Type	Subgroup
M-BMIN	1 pc.	Ø14-32, 9,6V/ 2,0 Ah	

Type: M-BMINI-S



Kit : compact rechargeable battery press machine + case + battery + charge unit 9,6 V, linear drive ca. 15 kN

Kit : hydraulische accu-persmachine + kunststofkoffer + lader + 1 accu 9,6 V, lineaire aandrijving ca. 15kN

Kit : machine à sertir hydraulique + boîte en plastique + chargeur + batterie 9,6 V, propulsion linéaire ca.15 kN

Kit : Hydraulisches Akku-Presswerkzeug + Kunststoffkoffer + Ladegerät + 1 Akku 9,6 V, lineare Schubkraft ca. 15 kN

Article number	Packing	Type	Subgroup
M-BMIN-S	1 pc.	Ø14-32, 9,6V/ 2,0 Ah	

Type: M-MACHMINI



Compact rechargeable battery press machine, linear drive ca. 15 kN

Hydraulische accu-persmachine, lineaire aandrijving ca. 15kN

Machine à sertir hydraulique, propulsion linéaire ca.15 kN

Hydraulisches Akku-Presswerkzeug, lineare Schubkraft ca. 15 kN

Article number	Packing	Type	Subgroup
M-MACHMIN	1 pc.	Ø14-32, 9,6V/ 2,0 Ah	

Type: M-BATMINI



Battery 9,6V / 2,0 Ah for M-BMINI

Accu 9,6V / 2,0 Ah voor M-BMINI

Batterie 9,6V / 2,0 Ah pour M-BMINI

Akku 9,6V / 2,0 Ah für M-BMINI

Article number	Packing	Type	Subgroup
M-BATMIN	1 pc.	9,6V/ 2,0 Ah	



Type: M-BOXMINI



Case for M-BMINI(-S)
Koffer voor M-BMINI(-S)
Coffret pour M-BMINI(-S)
Koffer für M-BMINI(-S)

Article number	Packing	Type	Subgroup
M-BOXMIN	1 pc.	M-BOXMIN	

Type: BE..-MINI



Jaw for press machine M-BMINI(2)(-S) and M-HP32
Bek voor persmachine M-BMINI(2)(-S) en M-HP32
Pince pour machine à sertir M-BMINI(2)(-S) et M-HP32
Pressbacke für Presswerkzeuge M-BMINI(2)(-S) und M-HP32

Article number	Packing	Type	Subgroup
BE16MIN	1 pc.	Ø16	
BE20MIN	1 pc.	Ø20	
BE26MIN	1 pc.	Ø26	
BE32MIN	1 pc.	Ø32	

Type: BE..-MMINI



M-pro□le jaw (copper) for press machine M-BMINI(2)(-S) and M-HP32
M-pro□el bek (koper) voor persmachine M-BMINI(2)(-S) en M-HP32
M-pro□ pincen (cuivre) pour machine à sertir M-BMINI(2)(-S) et M-HP32
M-pro□ Pressbacke (Kupfer) für Presswerkzeuge M-BMINI(2)(-S) und M-HP32

Article number	Packing	Type	Subgroup
BE15MMIN	1 pc.	Ø15Qu M-Pro:le	
BE22MMIN	1 pc.	Ø22Qu M-Pro:le	

Type: BE-C



V-pro□le jaw (copper) for press machine M-BMINI(2)(-S) and M-HP32
V-pro□el bek (koper) voor persmachine M-BMINI(2)(-S) en M-HP32
V-pro□ pincen (cuivre) pour machine à sertir M-BMINI(2)(-S) et M-HP32
V-pro□ Pressbacke (Kupfer) für Presswerkzeuge M-BMINI(2)(-S) und M-HP32

Article number	Packing	Type	Subgroup
BE15C	1 pc.	Ø15Qu V-Pro:le	
BE18C	1 pc.	Ø18Qu V-Pro:le	
BE22C	1 pc.	Ø22Qu V-Pro:le	
BE28C	1 pc.	Ø28Qu V-Pro:le	

- 1
- 2
- 3
- 4
- 5
- 6
- 7
- 8
- 9
- 10
- 11



Type: BE-MINI



Jaw mounting unit for press machine M-BMINI(2)(-S) / M-HP32 and to be used with BE-H jaws

Moederbek voor persmachine M-BMINI(2)(-S) / M-HP32 en te gebruiken met BE-H bekken

Pince mère pour machine à sertir M-BMINI(2)(-S) / M-HP32 et à utiliser avec pinces BE-H

Mutterpressbacke für Presswerkzeug M-BMINI(2)(-S) / M-HP32, zu verwenden mit BE-H Backen

Article number	Packing	Type	Subgroup
BE-MINI	1 pc.	BE-MINI	

BE-MINI is designed to press Henco press fittings, the interchangeable dies with M- and V-profile make it possible to make the transition from other materials to Henco; other than Henco branded fittings with compact measurements can cause complex manipulation

Type: BE-H



Inserts for BE-UNI, BE-MINI, M-BH

Wisselbekken voor BE-UNI, BE-MINI, M-BH

Pinces pour BE-UNI, BE-MINI, M-BH

Pressbacken für BE-UNI, BE-MINI, M-BH

Article number	Packing	Type	Subgroup
BE14H	1 Set (2 pc.)	BE 14X2 H	
BE16H	1 Set (2 pc.)	BE 16X2 H	
BE18H	1 Set (2 pc.)	BE 18X2 H	
BE20H	1 Set (2 pc.)	BE 20X2 H	
BE26H	1 Set (2 pc.)	BE 26X3 H	
BE32H	1 Set (2 pc.)	BE 32X3 H	

Type: BE-HC



Inserts (copper) for BE-UNI, BE-MINI, M-BH

Wisselbekken (koper) voor BE-UNI, BE-MINI, M-BH

Pinces (cuivre) pour BE-UNI, BE-MINI, M-BH

Pressbacken (Kupfer) für BE-UNI, BE-MINI, M-BH

Article number	Packing	Type	Subgroup
BE12HC	1 Set (2 pc.)	12Qu V-profile	
BE15HC	1 Set (2 pc.)	15Qu V-profile	
BE22HC	1 Set (2 pc.)	22Qu V-profile	
BE28HC	1 Set (2 pc.)	28Qu V-profile	

Type: BE-HM



Inserts (copper) for BE-UNI, BE-MINI, M-BH

Wisselbekken (koper) voor BE-UNI, BE-MINI, M-BH

Pinces (cuivre) pour BE-UNI, BE-MINI, M-BH

Pressbacken (Kupfer) für BE-UNI, BE-MINI, M-BH

Article number	Packing	Type	Subgroup
BE12HM	1 Set (2 pc.)	12Qu M-profile	
BE15HM	1 Set (2 pc.)	15Qu M-profile	
BE22HM	1 Set (2 pc.)	22Qu M-profile	



Type: M-HP



Hydraulic manual press tool + bag
 Hydraulisch handpersmachine + draagtas
 Machine à sertir manuelle hydraulique + sac
 Hydraulisches Handpressmaschine + Tasche

Article number	pc	Type	Subgroup
M-HP32	1 pc.	Ø14-32	

- 1
- 2
- 3
- 4
- 5
- 6
- 7
- 8
- 9
- 10
- 11

Type: M-BH



Kit: manual press machine + inserts 16,20,26 + bag
 Kit: handpersmachine + bekken 16, 20, 26 + draagtas
 Kit: machine à sertir manuelle + pinces 16, 20, 26 + sac
 Kit: Handpersmaschine + Pressbacken 16, 20, 26 + Tasche

Article number	Packing	Type	Subgroup
M-BH162026	1 pc.	BH16x2 / 20x2 / 26x3	

Type: BE-H



Inserts for BE-UNI, BE-MINI, M-BH
 Wisselbekken voor BE-UNI, BE-MINI, M-BH
 Pincés pour BE-UNI, BE-MINI, M-BH
 Pressbacken für BE-UNI, BE-MINI, M-BH

Article number	Packing	Type	Subgroup
BE14H	1 Set (2 pc.)	BE14X2 H	
BE16H	1 Set (2 pc.)	BE16X2 H	
BE18H	1 Set (2 pc.)	BE18X2 H	
BE20H	1 Set (2 pc.)	BE20X2 H	
BE26H	1 Set (2 pc.)	BE26X3 H	
BE32H	1 Set (2 pc.)	BE32X3 H	

Type: BE-HC



Inserts (copper) for BE-UNI, BE-MINI, M-BH
 Wisselbekken (koper) voor BE-UNI, BE-MINI, M-BH
 Pincés (cuivre) pour BE-UNI, BE-MINI, M-BH
 Pressbacken (Kupfer) für BE-UNI, BE-MINI, M-BH

Article number	Packing	Type	Subgroup
BE12HC	1 Set (2 pc.)	12Cu V-profile	
BE15HC	1 Set (2 pc.)	15Cu V-profile	
BE22HC	1 Set (2 pc.)	22Cu V-profile	
BE28HC	1 Set (2 pc.)	28Cu V-profile	



- 1
- 2
- 3
- 4
- 5
- 6
- 7
- 8
- 9
- 10
- 11

Type: BE-HM



Inserts (copper) for BE-UNI, BE-MINI, M-BH
 Wisselbekken (koper) voor BE-UNI, BE-MINI, M-BH
 Pincés (cuivre) pour BE-UNI, BE-MINI, M-BH
 Pressbacken (Kupfer) für BE-UNI, BE-MINI, M-BH

Article number	Packing	Type	Subgroup
BE12HM	1 Set (2 pc.)	12Qu M-profile	
BE15HM	1 Set (2 pc.)	15Qu M-profile	
BE22HM	1 Set (2 pc.)	22Qu M-profile	

Type: M-BM1620



Kit: manual press machine with 16, 20 jaws
 Kit: handpersmachine + wisselbekken 16, 20
 Kit: machine à sertir manuelle + pincés 16, 20
 Kit: Handpressmaschine + Pressbacken 16, 20

Article number	Packing	Type	Subgroup
M-BM1620	1 pc.	BM 16x2 / 20x2	

Type: BE-M



Inserts for M-BM1620
 Wisselbekken voor M-BM1620
 Pincés pour M-BM1620
 Pressbacken für M-BM1620

Article number	Packing	Type	Subgroup
BE14M	1 Set (2 pc.)	BE 14X2 M	
BE16M	1 Set (2 pc.)	BE 16X2 M	
BE18M	1 Set (2 pc.)	BE 18X2 M	
BE20M	1 Set (2 pc.)	BE 20X2 M	



Type: PRESSCHECK



Tool to control the accuracy of a pressing
 Instrument om correctheid v/e persing te controleren
 Outil pour contrôler la précision d'un sertissage
 Instrument zur Überprüfung ob die Pressung korrekt ausgeführt

Article number	Packing	Type	Subgroup
PRESSCHECK1432	1 pc.	Ø14-32	

- 1
- 2
- 3
- 4
- 5
- 6
- 7
- 8
- 9
- 10
- 11

Type: DRILLY



Drilly temporary air vent plug, reusable
 Drilly voor afdrukken leidingssysteem , herbruikbaar
 Drilly pour tester le système de tubes, réutilisable
 Drilly zum abdrukken Rohresysteme, wieder verwendbar

Article number	Packing	Type	Subgroup
DRILLY14	1 pc.	Ø14	
DRILLY16	1 pc.	Ø16	
DRILLY18	1 pc.	Ø18	
DRILLY20	1 pc.	Ø20	
DRILLY26	1 pc.	Ø26	
DRILLY32	1 pc.	Ø32	

Type: ENDCAP



End cap, temporary air vent plug
 Eindstop voor afdrukken leidingssysteem
 Bouchon purgeur pour tubes
 Stopf zum abdrukken Rohresysteme

Article number	Packing	Type	Subgroup
ENDCAP16	1 pc.	Ø16	

Type: PLUG



Plug
 Afdrukplug
 Bouchon
 Stopf

Article number	Tasche	Type	Subgroup
PLUG04-B80	20 pc.	1/2" - 80 mm blue	
PLUG04-R80	20 pc.	1/2" - 80 mm red	
PLUG05-B80	20 pc.	3/4" - 80 mm blue	
PLUG05-R80	20 pc.	3/4" - 80 mm red	
PLUG04-B55*	20 pc.	1/2" - 55 mm blue	

*TILL EXHAUSTION OF STOCK



Type: RRW-S



Pipe straightener max Ø20
Stangenmachine voor stangen max. Ø20
Machine à produire des barres Ø20 au max.
Stangenmaschine für die Stangen max.Ø20

Article number	Packing	Type	Subgroup
RRW-S	1 pc.	RRW	

Type: RRW-A



Pipe decoiler
Afolmachine
Machine à dérouler
Abwickelmaschine

Article number	Packing	Type	Subgroup
RRW-A	1 pc.	RRW	

Type: RRW-V



Connector to mount RRW-S on RRW-A
Verbindingsstuk om RRW-S op RRW-A te monteren
Raccord pour monter RRW-S sur RRW-A
Verbindungsstück um RRW-S auf RRW-A zu montieren

Article number	Packing	Type	Subgroup
RRW-V	1 pc.	RRW	

Type: UFH-VLA



Decoiler, standard model
Haspel, basismodel
Machine à dérouler, standard
Abwickelmaschine, Standard

Article number	Packing	Type	Subgroup
UFH-VLA	1 pc.	25 m - 600 m	



Type: UFH-VLG



Decoiler, tilting possible, on wheels
 Haspel, kantelbaar, op wielen
 Machine à dérouler, mobile et basculable
 Abwickelmaschine, mobil, drehbar

Artide number	Packing	Type	Subgroup
UFH-VLG	1 pc.	25 m - 600 m	

- 1
- 2
- 3
- 4
- 5
- 6
- 7
- 8
- 9
- 10
- 11

Type: UFH-TACK-TA38



Tacker machine for UFH-TACK-38K
 Tackerapparaat voor UFH-TACK-38K
 Appareil Tacker pour UFH-TACK-38K
 Tackergerät für UFH-TACK-38K

Artide number	Packing	Type	Subgroup
UFH-TACK-TA38	1 pc.	for UFH-TACK-38K	

Type: UFH-TACK



Tacker machine for UFH-TACK-40, UFH-TACK-60
 Tackerapparaat voor UFH-TACK-40, UFH-TACK-60
 Appareil Tacker pour UFH-TACK-40, UFH-TACK-60
 Tackergerät für UFH-TACK-40, UFH-TACK-60

Artide number	Packing	Type	Subgroup
UFH-TACK	1 pc.	for UFH-TACK-40 / UFH-TACK-60	

Type: UFH-RAS-VLE



Braid hook
 Vlechthaak
 Crochet de tressage
 Gerät zum Flechten von Stahldraht

Artide number	Packing	Type	Subgroup
UFH-RAS-VLE	1 pc.		



1
2
3
4
5
6
7
8
9
10
11

Type: UFH-RAS-CUT



Cutter for steel mesh
Kniptang voor stalen draadmatten
Pince coupante pour treillis
Schere für Trägermatte

Article number	Packing	Type	Subgroup
UFH-RAS-CUT	1 pc.		

Type: HNTOOLSET



Toolset for the Super Size range
Toolset voor het Super Size gamma
Toolset pour la gamme Super Size
Toolset für das Super Size Angebot

Article number	pc	Type	Subgroup
HNTOOLSET	1 pc.	Super Size	





Type: BCLIP



Clip-it clip for Henco pipes, single
 Clip-it beugel voor Henco buizen, enkel
 Clip-it attache de fixation pour tubes henco, simple
 Clip-it Bügel für Henco Rohre, einfach

Article number	Box	Type	Subgroup
BCLIP-14 *	100 pc.	Ø14	
BCLIP-16	100 pc.	Ø16	
BCLIP-1820	100 pc.	Ø18 - 20	
BCLIP-26	100 pc.	Ø26	
BCLIP-32	100 pc.	Ø32	
BCLIP-40	100 pc.	Ø40	
BCLIP-50	50 pc.	Ø50	

* TILL EXHAUSTION OF STOCK

Type: JCLIP



J-clip pipe clips, single
 J-clip beugels, enkel
 Attaches de fixation J-clip, simple
 J-clip Haken, einfach

Article number	Box	Type	Subgroup
JCLIP-1632	200 pc.	Ø16-32, 70 mm	

Type: JCLIP L



J-clip pipe clips, single
 J-clip beugels, enkel
 Attaches de fixation J-clip, simple
 J-clip Haken, einfach

Article number	Box	Type	Subgroup
JCLIP-1632L	200 pc.	Ø16-32, 97 mm	

Type: JCLIP DOUBLE



J-clip pipe clips, double
 J-clip beugels, dubbel
 Attaches de fixation J-clip, double
 J-clip Haken, doppelt

Article number	Box	Type	Subgroup
JCLIP-1632D	200 pc.	Ø16-32, 70 mm	



Type: JCLIP DOUBLE L



J-clip pipe clips, double
 J-clip beugels, dubbel
 Attaches de fixation J-clip, double
 J-clip Haken, doppelt

Article number	Box	Type	Subgroup
JCLIP-1632DL	200 pc.	Ø16-32, 97 mm	

- 1
- 2
- 3
- 4
- 5
- 6
- 7
- 8
- 9
- 10
- 11

Type: NCLIP



N-clip pipe clips, single
 N-clip beugels, enkel
 Attaches de fixation N-clip, simple
 N-clip Haken, einfach

Article number	Box	Type	Subgroup
NCLIP-1618	500 pc.	Ø16-18, 55 mm	
NCLIP-20	250 pc.	Ø20 + Ø14, 16, 18 with protection hose	
NCLIP-26	250 pc.	Ø26, 55 mm	

Type: NCLIP DOUBLE



N-clip pipe clips, double
 N-clip beugels, dubbel
 Attaches de fixation N-clip, double
 N-clip Haken, doppelt

Article number	Box	Type	Subgroup
NCLIP-20 DOUBLE	250 pc.	Ø20 + Ø14, 16, 18 with protection hose	

Type: PIPEPLUG



Protection cap for pipe
 Beschermstopje voor buis
 Capuchon de protection pour tube
 Schutzkappe für Rohr

Article number	Bag / Box	Type	Subgroup
PIPEPLUG16	100 pc. / 700 pc.	Ø16	



Type: PROCAPS PE-Xc/AL/PE-Xc



Protection caps for HENCO pipes
Instorthulzen voor beton, ter bescherming van de HENCO meerlagenbuis
Manchons protecteurs pour les tubes HENCO
Schutzhülse für HENCO Rohre

Article number	Box	Type	Subgroup
CAPS PE-Xc	48 pc.	Ø14-26	

Type: PROCAPS PVC/PP/PE



Protection caps for PVC, PP or PE pipes
Instorthulzen voor beton, ter bescherming van de PVC, PP, PE buizen
Manchons protecteurs pour les tubes PVC, PP et PE
Schutzhülse für PVC, PP und PE Rohre

Article number	Box	Type	Subgroup
CAPS PVC/PP/PE	48 pc.	Ø40	

CERTIFICATES - CERTIFICATEN - APPROBATIONS - ZERTIFIKATE



GERMANY



ITALY



AUSTRIA



AUSTRIA



FRANCE



THE NETHERLANDS



POLAND



DANMARK
DENMARK



Australian
Standard



RUSSIA



SLOVAKIA



ATG SYSTEM CERTIFICATE BELGIUM



SPAIN



FINLAND



HUNGARY



SWEDEN



USA



ENGLAND



SWITZERLAND



ESTONIA



NORWAY



THE ICELANDIC BUILDING RESEARCH INSTITUTE

ICELAND



CZECH REPUBLIC



SOUTH AFRICA

INDEX

Article number	Page	Article number	Page	Article number	Page	Article number	Page
03-160212	6	100-160212	5	10FK-261626	25	11-260626	88
03-180214	6	100-180214	5	10FK-261826	25	11-320632	88
03-200216	6	100-200216	5	10FK-262026	25	1-1403C	85
03-260320	6	100-F16R	15	10FK-321632	25	1-1404	85
03-320326	6	100-F20R	15	10FK-321832	25	1-1604	85
03-403533	6	100-ISO4-14-BL	7	10FK-322032	25	1-1604Z	85
03-504042	6	100-ISO4-14-RO	7	10FK-322632	25	1-1605	85
03-634554	6	100-ISO4-16-BL	7	10FK-401640	25	1-1804	85
03-R160212	12	100-ISO4-16-RO	7	10FK-402040	25	1-1805	85
03-R180214	12	100-ISO4-R16-BL	13	10FK-402640	25	11P-161414	68
03-R200216	12	100-ISO4-R16-RO	13	10FK-403240	25	11P-181616	68
03-R260320	12	100-MB	18	10FK-502050	25	11P-201616	68
04-160212	6	100-MBLACK	18	10FK-502650	25	11P-201818	68
04-180214	6	100-MG16	18	10FK-503250	25	11P-202016	68
04-200216	6	100-MR	18	10FK-504050	25	11P-261620	68
04-260320	6	100-R160212	12	10FK-632663	25	11P-262020	68
04-320326	6	100-R16MB	14	10FK-633263	25	11P-262616	68
04-403533	6	100-R16MBLACK	14	10FK-634063	25	11P-262620	68
04-504042	6	100-R16MR	14	10FK-635063	25	11P-322026	68
04-634554	6	100-R180214	12	10FK-754075	25, 44	11P-322626	68
04-R160212	12	100-R18MB	14	10FK-755075	25, 44	11PG-201616	81
04-R180214	12	100-R18MBLACK	14	10FK-756375	25, 44	11PG-202016	81
04-R200216	12	100-R18MR	14	10FK-904090	25, 44	11PG-261620	81
04-R260320	12	100-R200216	12	10FK-905090	25, 44	11PG-262020	81
05-160212	6	100-R20MB	14	10FK-906390	25, 44	11PG-262616	81
05-160212-GAS	19	100-R20MBLACK	14	10FK-907590	25, 44	11PG-322626	81
05-180214	6	100-R20MR	14	10FKG-201620	40	11PK-161414	26
05-200216	6	10-160212-KB	5	10FKG-261626	40	11PK-181616	26
05-200216-GAS	19	10-1604SN	88	10FKG-262026	40	11PK-201616	26
05-260320	6	10-161404SN	88	10FKG-321632	40	11PK-201818	26
05-260320-GAS	19	10P-161416	68	10FKG-322032	40	11PK-202016	26
05-320326	6	10P-181418	68	10FKG-322632	40	11PK-261616	26
05-320326-GAS	19	10P-181618	68	10FKG-401640	40	11PK-261620	26
05-403533	6	10P-201620	68	10FKG-402040	40	11PK-262016	26
05-403533-GAS	19	10P-201820	68	10FKG-402640	40	11PK-262020	26
05-504042	6	10P-261626	68	10FKG-403240	40	11PK-262616	26
05-634554	6	10P-261826	68	10FKW-201620	35	11PK-262620	26
05-756063	6	10P-262026	68	10FKW-201620	35	11PK-322026	26
05-907076	6	10P-321632	68	10FKW-261626	35	11PK-322626	26
05-R160212	12	10P-321832	68	10FKW-261626	35	11PK-402032	26
05-R180214	12	10P-322032	68	10FKW-262026	35	11PK-402632	26
05-R200216	12	10P-322632	68	10FKW-262026	35	11PK-403232	26
05-R260320	12	10PG-201620	81	10FKW-321632	35	11PK-404026	26
100-014MB	9	10PG-261626	81	10FKW-321632	35	11PK-404032	26
100-014MBLACK	9	10PG-262026	81	10FKW-322032	35	11PK-502040	26
100-014MR	9	10PG-321632	81	10FKW-322032	35	11PK-502640	26
100-016MB	9	10PG-322032	81	10FKW-322632	35	11PK-503240	26
100-016MBLACK	9	10PG-322632	81	10FKW-322632	35	11PK-504040	26
100-016MR	9	10FK-161416	25	10-R160212-KB	12	11PK-754040	26, 44
100-018MB	9	10FK-16JG1016	25	10SK-201620	54	11PK-754050	26, 44
100-018MBLACK	9	10FK-181418	25	10SK-261626	54	11PK-754063	26, 44
100-018MR	9	10FK-181618	25	10SK-262026	54	11PK-755050	26, 44
100-020MB	9	10FK-201420	25	11-160416	88	11PK-755063	26, 44
100-020MR	9	10FK-201620	25	11-200420	88	11PK-756363	26, 44
100-121688	5	10FK-201820	25	11-200520	88	11PK-904040	26, 44
100-140210	5	10FK-20JG1020	25	11-260526	88	11PK-904050	26, 44

INDEX

Article number	Page	Article number	Page	Article number	Page	Article number	Page
11FK-904050	26, 44	12P-202620	68	13FK-320532	27	14PK-260426	28
11FK-904063	26, 44	12P-263226	68	13FK-320632	27	14PK-260526	28
11FK-904075	26, 44	12PG-162016	81	13FK-320732	27	14PK-260626	28
11FK-905050	26, 44	12PG-202620	81	13FK-400640	27	14PK-320532	28
11FK-905063	26, 44	12PG-263226	81	13FK-400740	27	14PK-400640	28
11FK-905075	26, 44	12PK-161816	27	13FK-500850	27	14PK-400740	28
11FK-906363	26, 44	12PK-162016	27	13FK-631063	27	14PK-500850	28
11FK-906375	26, 44	12PK-202620	27	13FK-750675	27, 45	14PK-631063	28
11FK-907575	26, 44	12PK-263226	27	13FK-751075	27, 45	14PK-751075	28, 45
11FKG-201616	40	12PK-324032	27	13FK-751275	27, 45	14PK-751275	28, 45
11FKG-202016	40	12PK-405040	27	13FK-901490	27, 45	14PKG-160416	41
11FKG-261620	40	12PK-407540	27, 44	13FKG-160416BP	41	14PKG-200420	41
11FKG-262016	40	12PK-409040	27, 44	13FKG-200420BP	41	14PKG-200520	41
11FKG-262020	40	12PK-507550	27, 44	13FKG-200520	41	14PKG-260426	41
11FKG-262616	40	12PK-509050	27, 44	13FKG-260420BP	41	14PKG-260526	41
11FKG-262620	40	12PK-637563	27, 44	13FKG-260426BP	41	14PKG-260626	41
11FKG-322026	40	12PK-639063	27, 44	13FKG-260526	41	14PKG-320532	41
11FKG-322626	40	12PK-759075	27, 44	13FKG-320532	41	14PKG-400740	41
11FKG-402032	40	12PKG-162016	40	13FKG-320632	41	14PKW-160416	36
11FKG-402632	40	12PKG-202620	40	13FKG-320732	41	14PKW-160416	36
11FKG-403232	40	12PKG-263226	40	13FKG-400640	41	14SK-160416	55
11FKG-404026	40	12PKG-324032	40	13FKG-400740	41	14SK-200420	55
11FKG-404032	40	12PKW-162016	36	13FKW-160416BP*	36	14SK-260426	55
11FKW-201616	36	12PKW-162016	36	13FKW-160416BP*	36	15-160212-KB	5
11FKW-201616	36	12PKW-202620	36	13FKW-200420BP*	36	15P-1414	69
11FKW-202016	36	12PKW-202620	36	13FKW-200420BP*	36	15P-1616	69
11FKW-202016	36	12SK-162016	55	13FKW-200520	36	15P-1717	69
11FKW-261620	36	12SK-202620	55	13FKW-200520	36	15P-1818	69
11FKW-261620	36	13-1415	89	13FKW-260426BP*	36	15P-2020	69
11FKW-262016	36	13-1615A	89	13FKW-260426BP*	36	15P-2626	69
11FKW-262016	36	13-1615HA	89	13FKW-260526	36	15P-3232	69
11FKW-262020	36	13-2022HA	89	13FKW-260526	36	15PG-1616	82
11FKW-262020	36	1-3206	85	13FKW-320532	36	15PG-2020	82
11FKW-262616	36	13-2628H	89	13FKW-320532	36	15PG-2626	82
11FKW-262616	36	13P-160416	69	13FKW-320632	36	15PG-3232	82
11FKW-262620	36	13P-200420	69	13FKW-320632	36	15PK-1414	28
11FKW-262620	36	13P-200520	69	13SK-160416BP	55	15PK-1616	28
11FKW-322026	36	13P-260420	69	13SK-200420BP	55	15PK-1818	28
11FKW-322026	36	13P-260426	69	13SK-200520	55	15PK-2020	28
11FKW-322626	36	13P-260526	69	13SK-260420BP	55	15PK-2626	28
11FKW-322626	36	13P-320532	69	13SK-260426BP	55	15PK-3232	28
11SK-201616	55	13P-320632	69	13SK-260526	55	15PK-4040	28
11SK-202016	55	13P-320732	69	13-V2622H	89	15PK-5050	28
11SK-261620	55	13PG-160416	81	14P-160416	69	15PK-6363	28
11SK-262016	55	13PG-200420	81	14P-180418	69	15PK-7575	28, 45
11SK-262020	55	13PG-200520	81	14P-200420	69	15PK-9090	28, 45
11SK-262616	55	13PG-260426	81	14P-200520	69	15PKG-1616	41
11SK-262620	55	13PG-260526	81	14P-260426	69	15PKG-2020	41
1-2004	85	13PG-320632	81	14P-260526	69	15PKG-2626	41
1-2004Z	85	13PK-160416BP	27	14P-260626	69	15PKG-3232	41
1-2005	85	13PK-180418BP	27	14P-320532	69	15PKG-4040	41
120-FRT1620	17	13PK-200420BP	27	14P-320632	69	15PKW-1616	37
1-2605	85	13PK-200520	27	14FK-160416	28	15PKW-1616	37
1-2606	85	13PK-260420BP	27	14FK-180418	28	15PKW-2020	37
12P-161816	68	13PK-260426BP	27	14FK-200420	28	15PKW-2020	37
12P-162016	68	13PK-260526	27	14FK-200520	28	15PKW-2626	37

INDEX

Article number	Page	Article number	Page	Article number	Page	Article number	Page
15FKW-2626	37	16PKG-4026	42	17FKG-4006	42	18PK-5008	30
15FKW-3232	37	16PKG-4032	42	17FKG-4007	42	18PK-6310	30
15FKW-3232	37	16PKW-2016	37	17FKW-1604	37	18PK-7506	30, 46
15-R160212-KB	12	16PKW-2016	37	17FKW-1604	37	18PK-7510	30, 46
15SK-1616	56	16PKW-2620	37	17FKW-2004	37	18PK-7512	30, 46
15SK-2020	56	16PKW-2620	37	17FKW-2004	37	18PK-9014	30, 46
15SK-2626	56	16PKW-3220	37	17FKW-2005	37	18PKG-1604	42
16HNA	47	16PKW-3220	37	17FKW-2005	37	18PKG-2004	42
16P-1614	70	16PKW-3226	37	17FKW-2605	37	18PKG-2005	42
16P-1816	70	16PKW-3226	37	17FKW-2605	37	18PKG-2605	42
16P-2014	70	16SK-2016	56	17FKW-2606	37	18PKG-2606	42
16P-2016	70	16SK-2616	56	17FKW-2606	37	18PKG-3206	42
16P-2018	70	16SK-2620	56	17FKW-3206	37	18PKG-3207	42
16P-2616	70	17HNA-10	49	17FKW-3206	37	18PKG-4006	42
16P-2618	70	17HNA-12	49	17SK-1603	56	18PKG-4007	42
16P-2620	70	17P-1403	70	17SK-1604	56	18PKW-1604	37
16P-3216	70	17P-1404	70	17SK-2004	56	18PKW-1604	37
16P-3220	70	17P-1603	70	17SK-2005	56	18PKW-2004	37
16P-3226	70	17P-1604	70	17SK-2605	56	18PKW-2004	37
16PG-2016	82	17P-1804	70	17SK-2606	56	18PKW-2005	37
16PG-2616	82	17P-1805	70	17SKS-2004	57, 60	18PKW-2005	37
16PG-2620	82	17P-2004	70	17SKS-2005	57, 60	18PKW-2605	37
16PG-3216	82	17P-2005	70	17SKS-2604	57, 60	18PKW-2605	37
16PG-3220	82	17P-2605	70	17SKS-2605	57, 60	18PKW-2606	37
16PG-3226	82	17P-2606	70	18HNA-06	49	18PKW-2606	37
16FK-1614	29	17P-3206	70	18HNA-10	49	18PKW-3206	37
16FK-1814	29	17P-3207	70	18HNA-12	49	18PKW-3206	37
16FK-1816	29	17PG-1604	82	18HNB-14	49	18SK-1604	56
16FK-2014	29	17PG-2004	82	18P-1404	71	18SK-2004	56
16FK-2016	29	17PG-2005	82	18P-1604	71	18SK-2005	56
16FK-2018	29	17PG-2605	82	18P-1804	71	18SK-2605	56
16FK-2616	29	17PG-2606	82	18P-1805	71	18SK-2606	56
16FK-2618	29	17PG-3206	82	18P-2004	71	18SKS-2004	57, 61
16FK-2620	29	17PK-1404	30	18P-2005	71	18SKS-2005	57, 61
16FK-3216	29	17PK-1604	30	18P-2605	71	18SKS-2604	57, 61
16FK-3220	29	17PK-1804	30	18P-2606	71	18SKS-2605	57, 61
16FK-3226	29	17PK-1805	30	18P-3206	71	19P-1605	71
16FK-4026	29	17PK-2004	30	18P-3207	71	19P-1805	71
16FK-4032	29	17PK-2005	30	18PG-1604	82	19P-2005	71
16FK-5032	29	17PK-2605	30	18PG-2004	82	19PK-1605	31
16FK-5040	29	17PK-2606	30	18PG-2005	82	19PK-2005	31
16FK-6340	29	17PK-3206	30	18PG-2605	82	19SK-1605	57
16FK-6350	29	17PK-3207	30	18PG-2606	82	19SK-1605	60
16FK-7540	29, 45	17PK-4006	30	18PG-3206	82	19SK-2005	57
16FK-7550	29, 45	17PK-4007	30	18FK-1404	30	19SK-2005	60
16FK-7563	29, 45	17PK-5008	30	18FK-1604	30	1HNA	47
16FK-9040	29, 45	17PK-6310	30	18FK-1804	30	1HNB	47
16FK-9050	29, 45	17PK-7510	30, 46	18FK-1805	30	1P-1414	65
16FK-9063	29, 45	17PK-7512	30, 46	18FK-2004	30	1P-1616	65
16FK-9075	29, 45	17PKG-1604	42	18FK-2005	30	1P-1818	65
16FKG-2016	42	17PKG-2004	42	18FK-2605	30	1P-2020	65
16FKG-2616	42	17PKG-2005	42	18FK-2606	30	1P-2626	65
16FKG-2620	42	17PKG-2605	42	18FK-3206	30	1P-3232	65
16FKG-3216	42	17PKG-2606	42	18FK-3207	30	1PG-1616	79
16FKG-3220	42	17PKG-3206	42	18FK-4006	30	1PG-2020	79
16FKG-3226	42	17PKG-3207	42	18FK-4007	30	1PG-2626	79

INDEX

Article number	Page	Article number	Page	Article number	Page	Article number	Page
1PG-3232	79	23P-2004	72	25P-2004	72	28P-16041604	74
1PK-1414	21	240-PXC1820	16	25-R160212-KB	12	28PF-16041604	74
1PK-1616	21	24-1410	89	25-R16MB	14	28PK-04	31
1PK-16JG10	21	24-1615	89	25-R16BLACK	14	28PK-13FK1604BP	32
1PK-1818	21	24-2022	89	25-R16MR	14	28PK-2FK1604BP	32
1PK-2020	21	24-2622	89	25-R20MB	14	28PK-6FK1604BP	32
1PK-2626	21	24-2628	89	25-R20BLACK	14	28PV-16031603	74
1PK-3232	21	24P-1604	72	25-R20MR	14	28PV-16041604	74
1PK-4040	21	24P-1804	72	26P-14ZD4	73	29P-1612	75
1PK-5050	21	24P-2004	72	26P-1604	73	29P-1615	75
1PK-6363	21	25-014MB	9	26P-1605	73	29P-2018	75
1PK-7575	21, 44	25-014MBLACK	9	26P-16ZD3	73	29P-2022	75
1PK-9075	21, 44	25-014MR	9	26P-16ZD4	73	29P-2622	75
1PK-9090	21, 44	25-016MB	9	26P-16ZD5	73	2P-1404K	65
1PKG-1616	38	25-016MB-KB	10	26P-1805	73	2P-1604	65
1PKG-2020	38	25-016MR	9	26P-18ZD5	73	2P-1604K	65
1PKG-2626	38	25-016MR-KB	10	26P-2004	73	2P-1804	65
1PKG-3232	38	25-020MB	9	26P-2005	73	2P-2004	65
1PKG-4040	38	25-020MBLACK	9	26P-20ZD4	73	2P-2005	65
1PKW-1616	34	25-020MR	9	26P-20ZD5	73	2P-2605	65
1PKW-1616	34	25-026MB	9	26P-2605	73	2FG-1604	79
1PKW-2020	34	25-026MR	9	26P-2606	73	2FG-1604K	79
1PKW-2020	34	25-032GASMG	19	26P-26ZD6	73	2FG-2004	79
1PKW-2626	34	25-032MB	9	26P-3206	73	2FG-2005	79
1PKW-2626	34	25-032MBLACK	9	26P-32ZD6	73	2FG-2605	79
1PKW-3232	34	25-032MR	9	26P-3ZD7	73	2FK-1404BP	21
1PKW-3232	34	25-14141414	89	26PG-16ZD4	83	2FK-1603	21
1SK-1616	53	25-160212-KB	5	26PG-16ZD5	83	2FK-1604BP	21
1SK-2020	53	25-16161616	89	26PG-20ZD5	83	2FK-1604KBP	22
1SK-2626	53	25-18181818	89	26PG-26ZD6	83	2FK-1804BP	21
200-121688	5	25-200216	5	26PG-32ZD7	83	2FK-2004BP	21
200-140210	5	25-200216-KB	5	26FK-1605	31	2FK-2005	21
200-160212	5	25-20202020	89	26FK-2005	31	2FK-2605	21
200-180214	5	25-ISO13-32-BL	8	26FK-4008	31	2FKG-1603	38
200-F16R	15	25-ISO13-E20-BL	8	26FK-5010	31	2FKG-1604BP	38
200-F20R	15	25-ISO13-E26-BL	8	26FK-6312	31	2FKG-1604KBP	38
200-FRT1620	17	25-ISO26-E16-BL	8	26SK-1605	57	2FKG-2004BP	38
200-PXC1620	16	25-ISO26-E20-BL	8	26SK-2005	57	2FKG-2005	38
200-PXC1720	16	25-ISO26-E26-BL	8	27HNA	47	2FKG-2605	38
200-PXC2020	16	25-ISO4-26-BL	7	27HNB	47	2FKW-1604BP*	34
200-R160212	12	25-ISO4-26-RO	7	27P-2626	74	2FKW-1604BP*	34
200-R180214	12	25-ISO4-32-BL	7	27P-3232	74	2FKW-2004BP*	34
20P-1604	71	25-ISO4-32-RO	7	27FK-4040	31	2FKW-2004BP*	34
2-1414	85	25-ISO4-F26-BL	13	27FK-5050	31	2FKW-2005	34
2-1616	85	25-ISO4-F26-RO	13	27FK-6363	31	2FKW-2005	34
2-1818	85	25-ISO9-26-BL	7	27FK-7575	31, 46	2FKW-2605	34
21P-1504	71	25-ISO9-26-RO	7	27FK-9090	31, 46	2FKW-2606	34
2-2020	85	25-ISO9-32-BL	7	27FKG-4040	43	2SK-1604BP	53
2-2626	85	25-ISO9-32-RO	7	28-181618	90	2SK-2004BP	53
22P-1404	72	25-ISO9-F26-BL	13	28-201616	90	2SK-2005	53
22P-1604	72	25-ISO9-F26-RO	13	28-201620	90	2SK-2605	53
22P-1804	72	25-MB32	18	28-202016	90	30P-1614S	75
22P-2004	72	25-MG32	18	28-261626	90	30P-1615S	75
2-3232	85	25-MR32	18	28-262026	90	30P-2022S	75
23P-1604	72	25P-1604	72	28-322632	90	30P-2622S	75
23P-1804	72	25P-1804	72	28P-14041604	74	30PG-1615S	83

INDEX

Article number	Page	Article number	Page	Article number	Page	Article number	Page
30PG-2022S	83	4-1616	86	50-ISO4-R18-BL	13	53PK40	33
30PG-2622S	83	4-1818	86	50-ISO4-R18-RO	13	53PK50	33
3-1403C	85	4-2020	86	50-ISO4-R20-BL	13	53PK63	33
3-1404	85	4-2626	86	50-ISO4-R20-RO	13	5P-1404	66
3-1604	85	4-3232	86	50-ISO4-R26-BL	13	5P-1603	66
3-1804	85	4P-1604	66	50-ISO4-R26-RO	13	5P-1604	66
31P-161616	75	4P-1804	66	50-ISO9-14-BL	7	5P-1804	66
31P-161620	75	4P-2004	66	50-ISO9-14-RO	7	5P-2004	66
31P-201616	75	50-014MB	9	50-ISO9-16-BL	7	5P-2005	66
31P-201620	75	50-014MBLACK	9	50-ISO9-16-RO	7	5P-2605	66
31P-202020	75	50-014MR	9	50-ISO9-18-BL	7	5P-3206	66
3-2004	85	500-160212D	5	50-ISO9-18-RO	7	5PG-1604	80
3-2005	85	50-016GASMG	19	50-ISO9-20-BL	7	5PG-2004	80
3-2605	85	50-016MB	9	50-ISO9-20-RO	7	5PG-2005	80
3-2606	85	50-016MBLACK	9	50-ISO9-26-BL	7	5PG-2605	80
32P-1615P	76	50-016MR	9	50-ISO9-26-RO	7	5PG-3206	80
32P-2022P	76	50-018MB	9	50-ISO9-R16-BL	13	5PK-1404	23
32P-2622P	76	50-018MBLACK	9	50-ISO9-R16-RO	13	5PK-1604	23
3-3206	85	50-018MR	9	50-ISO9-R18-BL	13	5PK-1804	23
33P-1605	76	50-020GASMG	19	50-ISO9-R18-RO	13	5PK-2004	23
34P-1604	76	50-020MB	9	50-ISO9-R20-BL	13	5PK-2005	23
34P-1605	76	50-020MBLACK	9	50-ISO9-R20-RO	13	5PK-2605	23
34P-2005	76	50-020MR	9	50-MB20	18	5PK-3206	23
34P-3206	76	50-026GASMG	19	50-MB26	18	5PK-4007	23
35P-1612P	77	50-026MB	9	50-MBLACK20	18	5PK-5007	23
35P-1615P	77	50-026MBLACK	9	50-MBLACK26	18	5PK-5008	23
35P-2018P	77	50-026MR	9	50-MG16	18	5PK-6310	23
35P-2022P	77	500-F16R	15	50-MG20	18	5PK-7510	23, 44
35P-2622P	77	500-R160212	12	50-MG26	18	5PK-7512	23, 44
35P-3228P	77	50-140210	5	50-MR20	18	5PKG-1604	39
37P-1412	77	50-160212	5	50-MR26	18	5PKG-2004	39
37P-1412L	77	50-160212-GAS	19	50-R160212	12	5PKG-2005	39
37P-1612L	77	50-200216	5	50-R16MB	14	5PKG-2605	39
37P-1615L	77	50-200216-GAS	19	50-R16MBLACK	14	5PKG-3206	39
38P-160450	77	50-260320	5	50-R16MR	14	5PKG-4007	39
39P-160450	77	50-260320-GAS	19	50-R18MB	14	5PKW-1604	34
3EK-050405	92	50-320326	5	50-R18MBLACK	14	5PKW-1604	34
3P-160416	65	50-320326-GAS	19	50-R18MR	14	5PKW-2004	34
3P-200420	65	50-COMB14	10	50-R20MB	14	5PKW-2004	34
3PG-160416	80	50-COMB16	10	50-R20MBLACK	14	5PKW-2005	34
3PG-200420	80	50-COMB16R	14	50-R20MR	14	5PKW-2005	34
3PK-160416BP	22	50-ISO13-16-BL	8	50-R260320	12	5PKW-2605	34
3PK-200420BP	22	50-ISO13-18-BL	8	50-R26MB	14	5PKW-2605	34
3PKG-160416BP	39	50-ISO13-20-BL	8	50-R26MBLACK	14	5PKW-3206	34
3PKG-200420BP	39	50-ISO13-26-BL	8	50-R26MR	14	5PKW-3206	34
3PM-160416V	66	50-ISO13-E16-BL	8	5-1404	86	5SK-1604	54
3PM-160416VK	66	50-ISO13-E18-BL	8	5-1604	86	5SK-2004	54
3PM-200420V	66	50-ISO13-R16-BL	13	5-1804	86	5SK-2005	54
3PM-200420VK	66	50-ISO13-R20-BL	13	5-2005	86	5SK-2605	54
3SK-160416BP	53	50-ISO13-R26-BL	13	5-2605	86	600-PRT1620	17
3SK-200420BP	53	50-ISO4-18-BL	7	5-2606	86	600-PRT1720	17
400-F20R	15	50-ISO4-18-RO	7	52P16	78	600-PRT1820	17
40P-1615S	75	50-ISO4-20-BL	7	52P20	78	600-PRT2020	17
40P-2022S	75	50-ISO4-20-RO	7	52P26	78	600-PXC1620	16
40P-2622S	75	50-ISO4-26-BL	7	52P32	78	600-PXC1720	16
4-1414	86	50-ISO4-26-RO	7	5-3206	86	600-PXC2020	16

INDEX

Article number	Page	Article number	Page	Article number	Page	Article number	Page
6-1404	86	6SK-2004BP	54	9FK-909090	24, 44	BE15HC	159, 164, 165
6-1604	86	6SK-2005	54	9FKG-161616	39	BE15HM	159, 164, 166
6-1804	86	6SK-2605	54	9FKG-202020	39	BE15MMIN	163
6-1805	86	7-1404	87	9FKG-262626	39	BE16	157
6-2004	86	7-1604	87	9FKG-323232	39	BE16H	159, 164, 165
6-2005	86	7-160416	87	9FKG-404040	39	BE16M	166
6-2605	86	7-1804	87	9FKW-161616	35	BE16MIN	163
6-2606	86	7-2004	87	9FKW-161616	35	BE18	157
6-3206	86	7-2005	87	9FKW-202020	35	BE18C	163
6P-1404	67	7P-1605	67	9FKW-202020	35	BE18H	159, 164, 165
6P-1604	67	7P-1605K	67	9FKW-262626	35	BE18M	166
6P-1804	67	7P-1805	67	9FKW-262626	35	BE20	157
6P-2004	67	7P-2005	67	9FKW-323232	35	BE20H	159, 164, 165
6P-2005	67	8-141414	87	9FKW-323232	35	BE20M	166
6P-2605	67	8-161616	87	9SK-161616	54	BE20MIN	163
6P-3206	67	8-181818	87	9SK-202020	54	BE22C	163
6PG-1604	80	8-202020	87	9SK-262626	54	BE22HC	159, 164, 165
6PG-2004	80	8-262626	87	AB1420	91	BE22HM	159, 164, 166
6PG-2005	80	8-323232	87	ABEK04	91	BE22MMIN	163
6PG-2605	80	8HNA-FK40	48	AD-EKEK	92	BE26	157
6PG-3206	80	8HNA-FK50	48	AN1420	92	BE26H	159, 164, 165
6PK-1404BP	23	8HNA-FK63	48	AT1420	92	BE26MIN	163
6PK-1603	23	8HNA-FK75	48	BA-1288	151	BE28C	163
6PK-1604BP	23	8HNB-FK90	48	BA-1410	151	BE28HC	159, 164, 165
6PK-1804BP	23	8P-1604	67	BA-1612	151	BE32	157
6PK-2004BP	23	9-140414	88	BA-1814	151	BE32H	159, 164, 165
6PK-2005	23	9-160416	88	BA-2016	151	BE32MIN	163
6PK-2605	23	9-180418	88	BA-CC	104	BE40	157
6PK-3206	23	9-180518	88	BA-CH	104	BE50	157
6PK-4007	23	9-200420	88	BA-CS	105	BE63	157
6PK-5007	23	9-200520	88	BAP-H1616	103	BE-BOX	159
6PK-5008	23	9-260526	88	BAP-H2020	103	BE-MIN	164
6PK-6310	23	9-260626	88	BAP-H2626	103	BE-UN	159
6PK-7506	23, 44	9-320632	88	BAP-H3232	103	BE-UNSET1	157
6PK-7510	23, 44	9HNA	47	BAP-SK1616	104	BE-UNSET2	157
6PK-7512	23, 44	9HNB	47	BAP-SK2020	104	BI-1410	151
6PK-9014	23, 44	9P-141414	67	BAP-SK2626	104	BI-1612	151
6PKG-1604BP	39	9P-161616	67	BAP-SV1610S	104	BI-1612L	151
6PKG-2004BP	39	9P-181818	67	BQLIP-14	172	BI-1814	151
6PKG-2005	39	9P-202020	67	BQLIP-16	172		
6PKG-2605	39	9P-262626	67	BQLIP-1820	172		
6PKG-3206	39	9P-323232	67	BQLIP-26	172		
6PKG-4007	39	9FG-161616	80	BQLIP-32	172		
6PKW-1603	35	9FG-202020	80	BQLIP-40	172		
6PKW-1603	35	9FG-262626	80	BQLIP-50	172		
6PKW-1604BP*	35	9FG-323232	80	BE12HC	159, 164, 165		
6PKW-1604BP*	35	9FK-141414	24	BE12HM	159, 164, 166		
6PKW-2004BP*	35	9FK-161616	24	BE14	157		
6PKW-2004BP*	35	9FK-181818	24	BE14H	159, 164, 165		
6PKW-2005	35	9FK-202020	24	BE14M	166		
6PKW-2005	35	9FK-262626	24	BE15C	163		
6PKW-2605	35	9FK-323232	24				
6PKW-2605	35	9FK-404040	24				
6PKW-3206	35	9FK-505050	24				
6PKW-3206	35	9FK-636363	24				
6SK-1604BP	54	9FK-757575	24, 44				

INDEX

Article number	Page	Article number	Page	Article number	Page	Article number	Page
BI-2016	151	KS26M	154	RADV-2-R	102	UFH+0405LTV05	131
BI-2016L	151	KS32M	154	RRWA	168	UFH+0405LTV06	131
BI-2620	151	KS40M	154	RRWS	168	UFH+0405LTV07	131
BM-16	151	KS50	154	RRWV	168	UFH+0405LTV08	131
BM-20	151	KS63	154	RS1420PRESS	152	UFH+0405LTV09	131
BM-26	151	KS-K	155	RS1420PRESS-N	152	UFH+0405LTV10	131
BP04	22	KS-MSET1	154	RS1435F	153	UFH+0405LTV11	131
CAPS FE-Xc	174	KS-MSET2	154	RS2640PRESS	152	UFH+0405LTV12	131
CAPS PVC/PP/PE	174	KS-P162026	155	RS32	152	UFH+0405S01	129
DRILLY14	167	LB45	10	RS63	152	UFH+0405S02	129
DRILLY16	167	LB50	10	RSEM1420-FERS	152	UFH+0405S03	129
DRILLY18	167	M-BA00	155	RSEM1435F	153	UFH+0405S04	129
DRILLY20	167	M-BAT	155	RSEM2640-FERS	152	UFH+0405S05	129
DRILLY26	167	M-BATMIN	162	RSEM32	153	UFH+0405S06	129
DRILLY32	167	M-BATMIN2	161	RSEM63	153	UFH+0405SECC01	130
EK12	90	M-BH162026	165	SAFECUT	153	UFH+0405SECC02	130
EK14	90	M-BHY	156	SK-B05	62	UFH+0405SECC03	130
EK15	101	M-BH162026	156	SK-PIESTOP16	58	UFH+0405SECC04	130
EK15	90	M-BM1620	165	SK-PIESTOP20	58	UFH+0405SECC05	130
EK16	90	M-BMIN	162	SK-PIESTOP26	58	UFH+0405SECC06	130
EK17	90	M-BMIN2	160	SK-STOPCLIP16	58	UFH+0405SSTED1	131
EK18	90	M-BMIN2-S	160	SK-STOPCLIP16	62	UFH+0405SSTED2	131
EK20	90	M-BMIN2-SLB	160	SK-STOPCLIP20	58	UFH+0405SSTED3	131
EK116	90	M-BMIN-S	162	SK-STOPCLIP20	62	UFH+0405SSTED4	131
ENDCAP16	167	M-BOMBHY	156	SK-STOPCLIP26	58	UFH+0405SSTED5	131
ENDCAP-EK05	62	M-BOMMIN	163	SK-STOPCLIP26	62	UFH+0405SSTED6	131
H-0212	97	M-BOMMIN2	161	SPLIT12	91	UFH+0405SSTND1	130
H-0212-S	98	M-HP32	165	SPLIT14	91	UFH+0405SSTND2	130
H716042005	53	M-LAD	155	SPLIT16	91	UFH+0405SSTND3	130
H716042005	87	M-LADMIN2	161	SPLIT17	91	UFH+0405SSTND4	130
H716042005	22	M-MACHMIN	162	SPLIT18	91	UFH+0405SSTND5	130
HNA	48	M-TRANS	156	SPLIT20	91	UFH+0405SSTND6	130
HNA-ECCLINE-SET	50, 51	M-TRANSMIN2	161	SPLIT-S16	91	UFH+0505CAFF07	127
HNA-EK05	49	ND4	73	SPLIT-S20	91	UFH+0505CAFF08	127
HNA-EK05	49	ND5	73	SS2P04	4	UFH+0505CAFF09	127
HNA-STOP	49	ND605	73	SS2P05	4	UFH+0505CAFF10	127
HNA-U	48	NCLIP-1618	173	SS3P04	4	UFH+0505CAFF11	127
HNB	48	NCLIP-20	173	SS4P04	4	UFH+0505CAFF12	127
HNB-STOP	49	NCLIP-20DOUBLE	173	TOOLBOX16202632	158	UFH+0505CAFF13	127
HNB-U	48	NCLIP-26	173	TOOLBOX405063	158	UFH+0505CAFF14	127
HN-PEN	48	PIPEPLUG16	173	UFH+0405CAFF01	127	UFH+0505CAFF15	127
HNTOOLSET	170	PLUG04-B55	167	UFH+0405CAFF02	127	UFH+0505CAFF16	127
ID2-EK	93	PLUG04-B80	167	UFH+0405CAFF03	127	UFH+0505ODF07	126
ID-EK	93	PLUG04-F80	167	UFH+0405CAFF04	127	UFH+0505ODF08	126
ISO-BLOCK-L	11	PLUG05-B80	167	UFH+0405CAFF05	127	UFH+0505ODF09	126
ISO-BLOCK-S	10	PLUG05-F80	167	UFH+0405CAFF06	127	UFH+0505ODF10	126
ISO-BOX	76	PRESSO-ECK1432	167	UFH+0405ODP01	126	UFH+0505ODP11	126
JCLIP-1632	172	RAD04-100H	101	UFH+0405ODP02	126	UFH+0505ODP12	126
JCLIP-1632D	172	RAD04-100V	101	UFH+0405ODP03	126	UFH+0505ODP13	126
JCLIP-1632DL	173	RAD-B	103	UFH+0405ODP04	126	UFH+0505ODP14	126
JCLIP-1632L	172	RAD-H	103	UFH+0405ODP05	126	UFH+0505ODP15	126
KS12M	154	RADH-100H	102	UFH+0405ODP06	126	UFH+0505ODP16	126
KS14M	154	RADH-100V	102	UFH+0405LTV01	131	UFH+0505CDMED1	128
KS16M	154	RADK2-R	101	UFH+0405LTV02	131	UFH+0505CDMED2	128
KS18M	154	RADN-0504	103	UFH+0405LTV03	131	UFH+0505CDMED3	128
KS20M	154	RADTH-VL	102	UFH+0405LTV04	131	UFH+0505CDMED4	128

INDEX

Article number	Page	Article number	Page	Article number	Page	Article number	Page
UFH+0505CDWE05	128	UFH+060506-MD	121	UFH+0605CD16	125	UFH+ADN10	120
UFH+0505CDWE06	128	UFH+060506-MR	121	UFH+0605CD17	125	UFH+ANC-05	140
UFH+0505CDWE07	128	UFH+060506-RVSD	124	UFH+0605CD18	125	UFH+ANC-06	140
UFH+0505CDWE08	128	UFH+060507-MD	121	UFH+0605CD19	125	UFH+AC03-MZ	123
UFH+0505CDWE09	128	UFH+060507-MR	121	UFH+0605CD20	125	UFH+B0606-M	123
UFH+0505CDWE10	128	UFH+060507-RVSD	124	UFH+0605CD3W01	127	UFH+B0606-VN	124
UFH+0505CDWE11	128	UFH+060508-MD	121	UFH+0605CD3W02	127	UFH+BEND1218	120
UFH+0505CDWE12	128	UFH+060508-MR	121	UFH+0605CD3W03	127	UFH+BEND20	120
UFH+0505CDWE13	128	UFH+060508-RVSD	124	UFH+0605CD3W04	127	UFH+BS05-M	124
UFH+0505CDWE14	128	UFH+060509-MD	121	UFH+0605CD3W05	127	UFH+BTM0606-M	122
UFH+0505CDWE15	128	UFH+060509-MR	121	UFH+0605CD3W06	127	UFH+BTM0606-VN	124
UFH+0505CDWE16	128	UFH+060509-RVSD	124	UFH+0605CD3W07	127	UFH+C191645	141
UFH+0505S07	129	UFH+060510-MD	121	UFH+0605CD3W08	127	UFH+C191800	142
UFH+0505S08	129	UFH+060510-MR	121	UFH+0605CD3W09	127	UFH+C191902	141
UFH+0505S09	129	UFH+060510-RVSD	124	UFH+0605CD3W10	127	UFH+C191974	141
UFH+0505S10	129	UFH+060511-MD	121	UFH+0605CD3W11	127	UFH+C191976	141
UFH+0505S11	129	UFH+060511-MR	121	UFH+0605CD3W12	127	UFH+C192071	141
UFH+0505S12	129	UFH+060511-RVSD	124	UFH+0605CD3W13	127	UFH+CAB-11000	149
UFH+0505S13	129	UFH+060512-MD	121	UFH+0605CD3W14	127	UFH+CAB-I400	149
UFH+0505S14	129	UFH+060512-MR	121	UFH+0605CD3W15	127	UFH+CAB-I600	149
UFH+0505S15	129	UFH+060512-RVSD	124	UFH+0605CD3W16	127	UFH+CAB-I800	149
UFH+0505S16	129	UFH+0605CAF01	126	UFH+0605CD3W17	127	UFH+CAB-O1000	149
UFH+0505SECO07	130	UFH+0605CAF02	126	UFH+0605CD3W18	127	UFH+CAB-C400	149
UFH+0505SECO08	130	UFH+0605CAF03	126	UFH+0605CD3W19	127	UFH+CAB-C600	149
UFH+0505SECO09	130	UFH+0605CAF04	126	UFH+0605CD3W20	127	UFH+CAB-C800	149
UFH+0505SECO10	130	UFH+0605CAF05	126	UFH+0605CD4W01	128	UFH+CP	129
UFH+0505SECO11	130	UFH+0605CAF06	126	UFH+0605CD4W02	128	UFH+DH#0	119
UFH+0505SECO12	130	UFH+0605CAF07	126	UFH+0605CD4W03	128	UFH+DP200	119
UFH+0505SECO13	130	UFH+0605CAF08	126	UFH+0605CD4W04	128	UFH+DRY-B	116
UFH+0505SECO14	130	UFH+0605CAF09	126	UFH+0605CD4W05	128	UFH+DRY-GP100/2	116
UFH+0505SECO15	130	UFH+0605CAF10	126	UFH+0605CD4W06	128	UFH+DRY-VD100	116
UFH+0505SECO16	130	UFH+0605CAF11	126	UFH+0605CD4W07	128	UFH+ESK060303-M	123
UFH+0505SSTED7	131	UFH+0605CAF12	126	UFH+0605CD4W08	128	UFH+ESK060303-VN	125
UFH+0505SSTED8	131	UFH+0605CAF13	126	UFH+0605CD4W09	128	UFH+EXTRAZ24V-W	135
UFH+0505SSTED9	131	UFH+0605CAF14	126	UFH+0605CD4W10	128	UFH+EXTRAZONE-R	135
UFH+0505SSTE10	131	UFH+0605CAF15	126	UFH+0605CD4W11	128	UFH+EXTRAZONE-W	134
UFH+0505SSTE11	131	UFH+0605CAF16	126	UFH+0605CD4W12	128	UFH+FOIL50	117
UFH+0505SSTE12	131	UFH+0605CAF17	126	UFH+0605CD4W13	128	UFH+FOIL90	117
UFH+0505SSSTN07	130	UFH+0605CAF18	126	UFH+0605CD4W14	128	UFH+FOIL-ALU	118
UFH+0505SSSTN08	130	UFH+0605CAF19	126	UFH+0605CD4W15	128	UFH+FOIL-CLIP25	118
UFH+0505SSSTN09	130	UFH+0605CAF20	126	UFH+0605CD4W16	128	UFH+FOIL-N	118
UFH+0505SSSTN10	130	UFH+0605CD01	125	UFH+0605CD4W17	128	UFH+GB26100	147
UFH+0505SSSTN11	130	UFH+0605CD02	125	UFH+0605CD4W18	128	UFH+GKT	122
UFH+0505SSSTN12	130	UFH+0605CD03	125	UFH+0605CD4W19	128	UFH+H5004	140
UFH+060502-MD	121	UFH+0605CD04	125	UFH+0605CD4W20	128	UFH+ICE-R	140
UFH+060502-MR	121	UFH+0605CD05	125	UFH+0626CD01	147	UFH+ISO-20	108
UFH+060502-RVSD	124	UFH+0605CD06	125	UFH+0626CD02	147	UFH+ISO-30	108
UFH+060503-MD	121	UFH+0605CD07	125	UFH+0626CD03	147	UFH+ISOCBOARD-G	119
UFH+060503-MR	121	UFH+0605CD08	125	UFH+0626CD04	147	UFH+ISOCBOARD-S	119
UFH+060503-RVSD	124	UFH+0605CD09	125	UFH+0626CD05	147	UFH+ISODRY-25	115
UFH+060504-MD	121	UFH+0605CD10	125	UFH+0626CD06	147	UFH+ISOPRO11	108
UFH+060504-MR	121	UFH+0605CD11	125	UFH+0626CD07	147	UFH+ISOPRO30	108
UFH+060504-RVSD	124	UFH+0605CD12	125	UFH+0626CD08	147	UFH+ISOPRO-AD11	109
UFH+060505-MD	121	UFH+0605CD13	125	UFH+ACT230NC2	139	UFH+ISOPRO-AD30	109
UFH+060505-MR	121	UFH+0605CD14	125	UFH+ACT230NC4	139	UFH+KTR001	138
UFH+060505-RVSD	124	UFH+0605CD15	125	UFH+ACT24NC2	139	UFH+MAX95	132

INDEX

Article number	Page	Article number	Page	Article number	Page	Article number	Page
UFH-MAXB55	132	UFH-THERM-W	135	V-070407-Z	96	VISION-KEY20	58
UFH-M-D	121	UFH-THERM-W/D	136	V-070408-Z	96	VISION-KEY26	58
UFH-MP01	120	UFH-TIMER-W	136	V-070409-Z	96	VR-EK05	99
UFH-P18-EGA	115	UFH-TM050-M	123	V-070410-Z	96	VS-05	98
UFH-P18-GP10	114	UFH-TRANS230V24	134	VALVE-SET14	106	VS-0504	98
UFH-P18-GP18	114	UFH-TTB2050	132	VALVE-SET3	105	VS-06	98
UFH-P18-GP18V	114	UFH-TTBD2050	131	VALVE-SET7	105	VS-0604	98
UFH-P18-SC	115	UFH-TV0628	132	VB050502-BLAUW	99	VS-0605	98
UFH-P18-VL	115	UFH-UP-12	117	VB050503-ROOD	99	VS-07	98
UFH-P18-VN	114	UFH-UP-14	117	VB050503-BLAUW	99	VS-0706	98
UFH-PGFM01	122	UFH-UP-14M1	116	VB050503-ROOD	99	VS-ENDCAP	61
UFH-PGKTA	122	UFH-UP-16	117	VB050504-BLAUW	99	VS-ENDCAP-M	61
UFH-PLUG80	118	UFH-UP-16M1	116	VB050504-ROOD	99	VSK-1616	59
UFH-PRO	108	UFH-UP-1826M1Z	117	VB060502-BLAUW	99	VSK-161616	59
UFH-PRO-ADA	109	UFH-UP-20	117	VB060502-ROOD	99	VSK-0502	59
UFH-PRO-DIA	109	UFH-UP-CLP50	117	VB060503-BLAUW	99	VSK-0503	59
UFH-PRO-IND	110	UFH-VLA	168	VB060503-ROOD	99	VSK-20	60
UFH-PRO-IND-B	110	UFH-VLG	169	VB060504-BLAUW	99	VSK-20-90	61
UFH-RAS10	110	UFH-ZONE24VW	133	VB060504-ROOD	99	VSK-26	60
UFH-RAS15	110	UFH-ZONE-B	133	VB-EK05	98	VSK-26-90	61
UFH-RAS20	111	UFH-ZONEHC-B	133	VDSK-20	62	VSK-T202020	61
UFH-RAS25	111	UFH-ZONEHC-R	134	VDSK-26	62	VSK-T20M20	60
UFH-RAS-BIND15A	111	UFH-ZONE-R	134	VEK-050502-Z	97	VSK-T262626	61
UFH-RAS-BIND15B	111	UFH-ZONE-W	133	VEK-050502-ZV	97	VSK-T26M26	60
UFH-RAS-CLIP16	112	V-050402-Z	95	VEK-050503-Z	97		
UFH-RAS-CLIP18	112	V-050403-Z	95	VEK-050503-ZV	97		
UFH-RAS-CLIP20	112	V-050404-Z	95	VEK-050504-Z	97		
UFH-RAS-CUT	170	V-050405-Z	95	VEK-050505-Z	97		
UFH-RAS-EB3	111	V-050406-Z	95	VEK-050506-Z	97		
UFH-RAS-VLE	169	V-050407-Z	95	VEK-050507-Z	97		
UFH-SCOTCH-66	113	V-050408-Z	95	VEK-050508-Z	97		
UFH-SENSOR	139	V-050409-Z	95	VEK-050509-Z	97		
UFH-TACK	169	V-050410-Z	95	VEK-050510-Z	97		
UFH-TACK-38K	113	V-060402	95	VEK-060502	96		
UFH-TACK-40	113	V-060402-Z	95	VEK-060502-Z	96		
UFH-TACK-60	113	V-060403	95	VEK-060502-ZV	97		
UFH-TACK-KLS15	112	V-060403-Z	95	VEK-060503	96		
UFH-TACK-KLS20	112	V-060404	95	VEK-060503-Z	96		
UFH-TACK-KLS25	112	V-060404-Z	95	VEK-060504	96		
UFH-TACK-KLS30	112	V-060405	95	VEK-060504-Z	96		
UFH-TACK-KLS35	112	V-060405-Z	95	VEK-060505	96		
UFH-TACK-RCL20	112	V-060406	95	VEK-060505-Z	96		
UFH-TACK-RCL25	112	V-060406-Z	95	VEK-060506	96		
UFH-TACK-RCL30	112	V-060407	95	VEK-060506-Z	96		
UFH-TACK-RCL35	112	V-060407-Z	95	VEK-060507	96		
UFH-TACK-TA38	169	V-060408	95	VEK-060507-Z	96		
UFH-THERM24V-W	135	V-060408-Z	95	VEK-060508	96		
UFH-THERM24V-WD	136	V-060409	95	VEK-060508-Z	96		
UFH-THERM-B	136	V-060409-Z	95	VEK-060509	96		
UFH-THERM-BD	137	V-060410	95	VEK-060509-Z	96		
UFH-THERMH-C-B	137	V-060410-Z	95	VEK-060510	96		
UFH-THERMH-C-BD	137	V-070402-Z	96	VEK-060510-Z	96		
UFH-THERMH-C-R	138	V-070403-Z	96	VISION SET 16	58		
UFH-THERMH-C-RD	138	V-070404-Z	96	VISION SET 20	58		
UFH-THERM-R	137	V-070405-Z	96	VISION SET 26	58		
UFH-THERM-RD	138	V-070406-Z	96	VISION-KEY16	58		



Technische veranderingen en drukfouten voorbehouden

•

Technical amendments and printing errors reserved

•

Changements techniques et fautes d'impression sous réserve

•

Technische Änderungen und Druckfehler vorbehalten



DO02-00151N00



Henco Industries NV • Toekomstlaan 27, 2200 Herentals • Tel. +32 14 28 56 60 • www.henco.be

