



MUFLE®

MUFLE PROIZVODI: kanali

od polietilena velike gustine



4ALL
DESIGN

REŠETKA SA PROREZIMA OD

POCINKOVANOG ČELIKA



KLASA A15

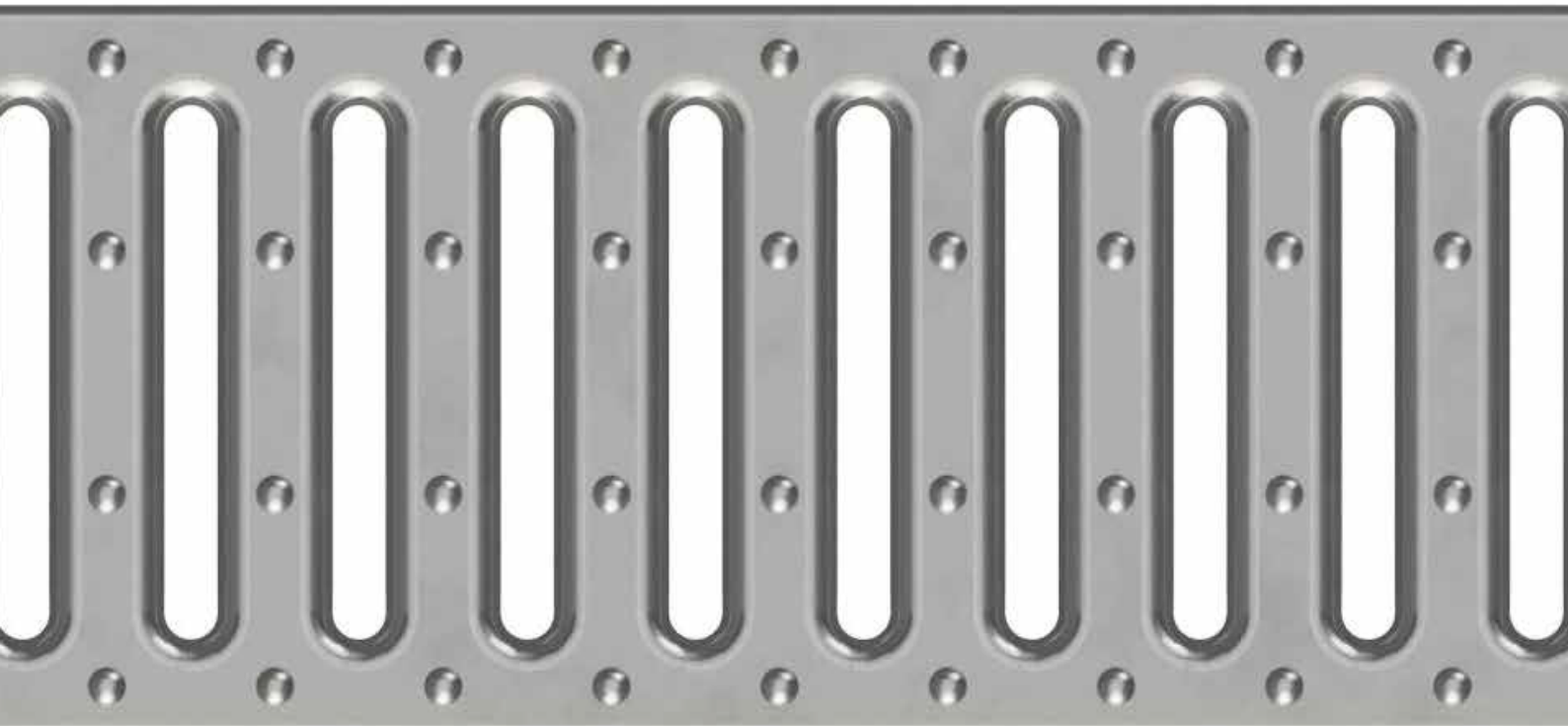

REŠETKA SA PROREZIMA OD

NERĐAJUĆEG ČELIKA - INOX

sa plavom zaštitnom folijom



KLASA A15

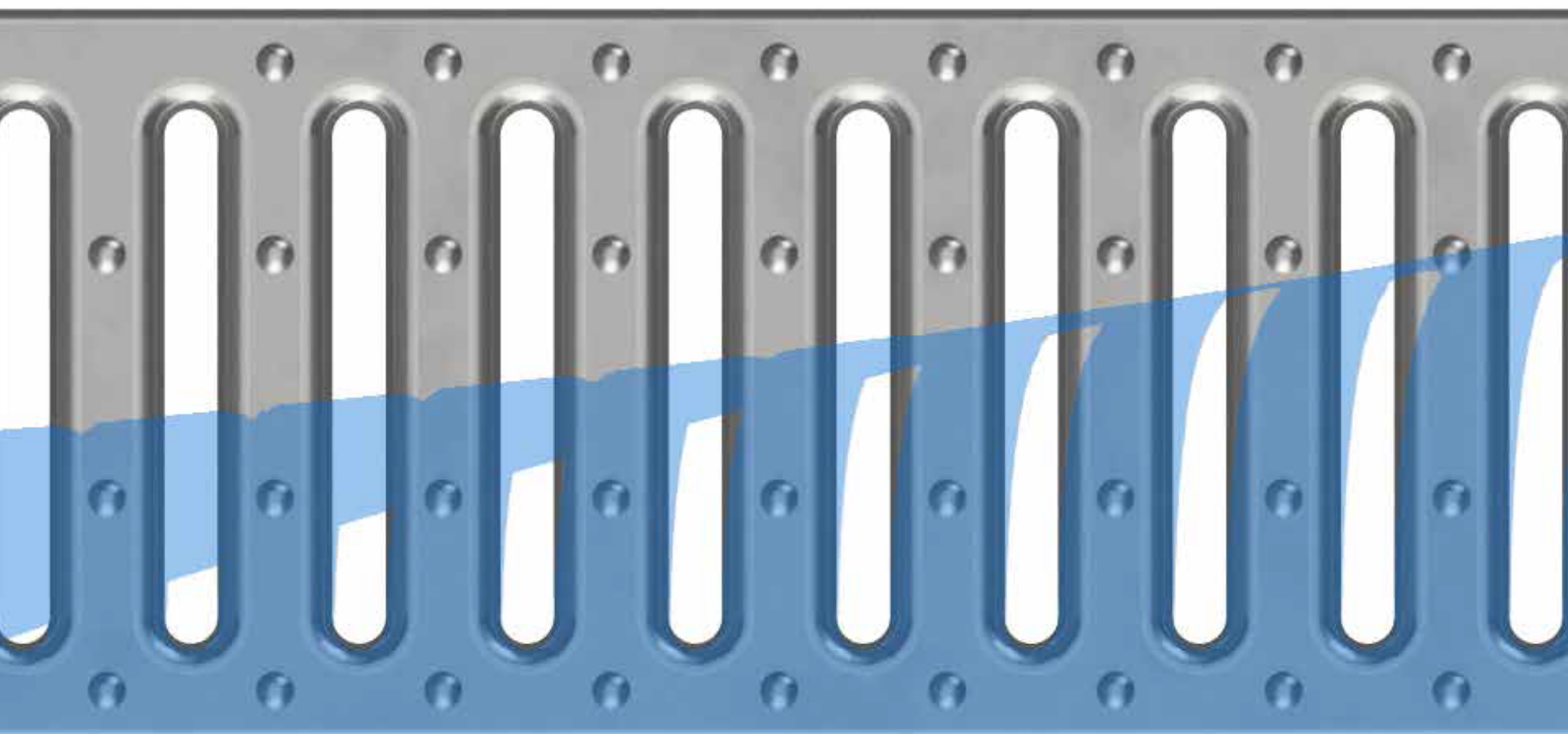

REŠETKA SA "SLIM" PROREZIMA OD
POCINKOVANOG ČELIKA



KLASA A15

**NOVI
DIZAJN**

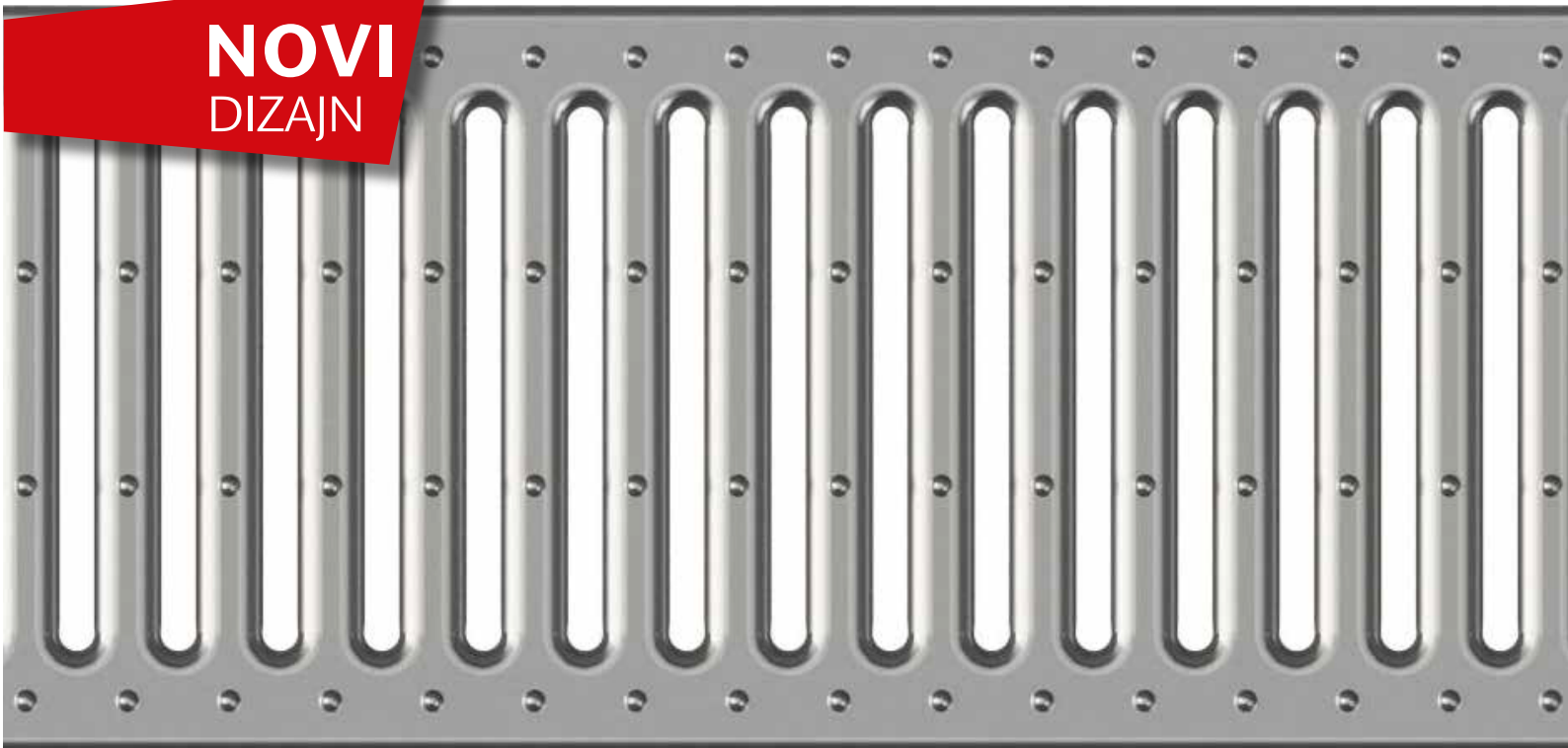

REŠETKA SA "SLIM" PROREZIMA OD
NERĐAJUĆEG ČELIKA (INOX)

sa plavom zaštitnom folijom



KLASA A15

**NOVI
DIZAJN**

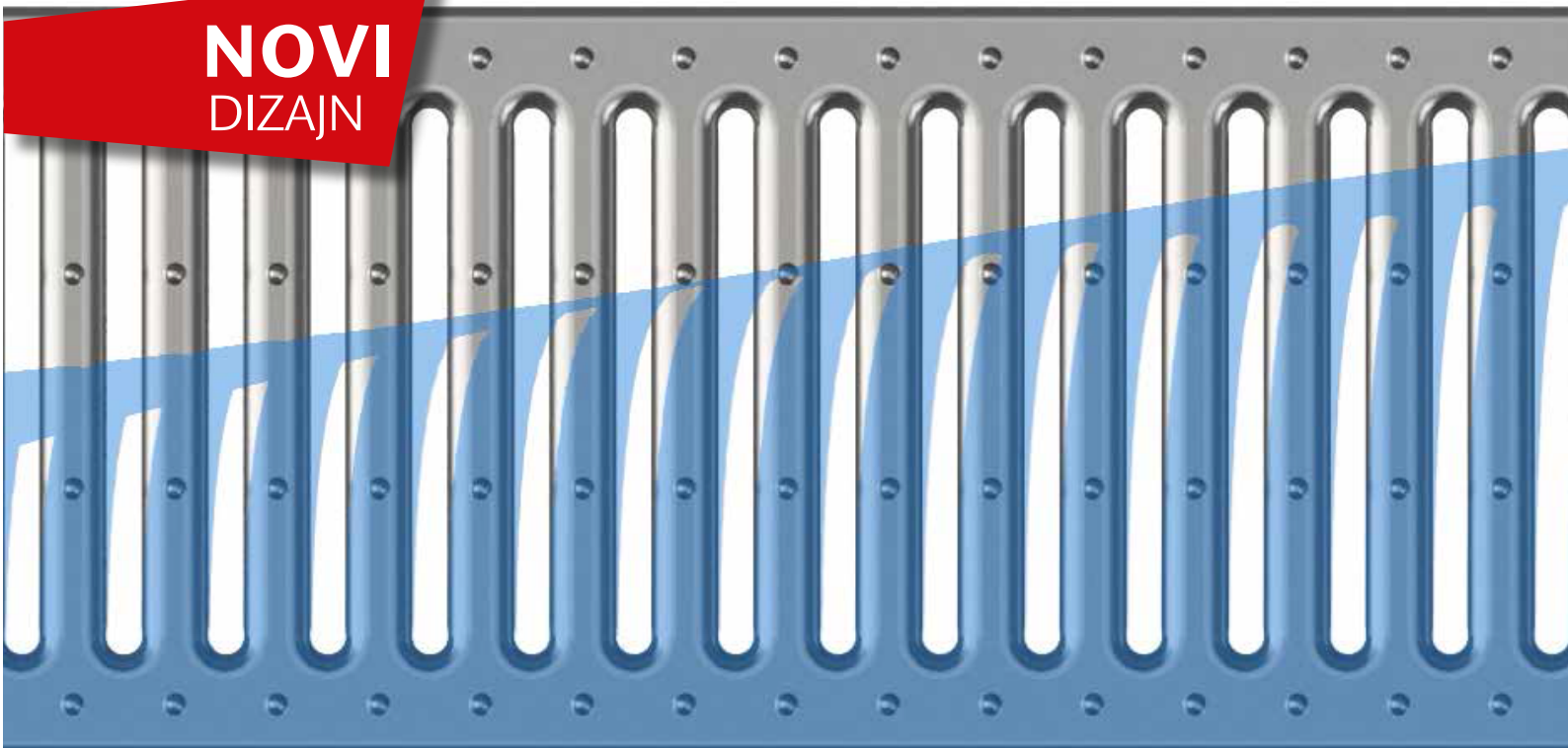

500mm REŠETKA OD
LIVENOG GVOŽĐA



KLASA B125

NOVA
KLASA OPTEREĆENJA
B125

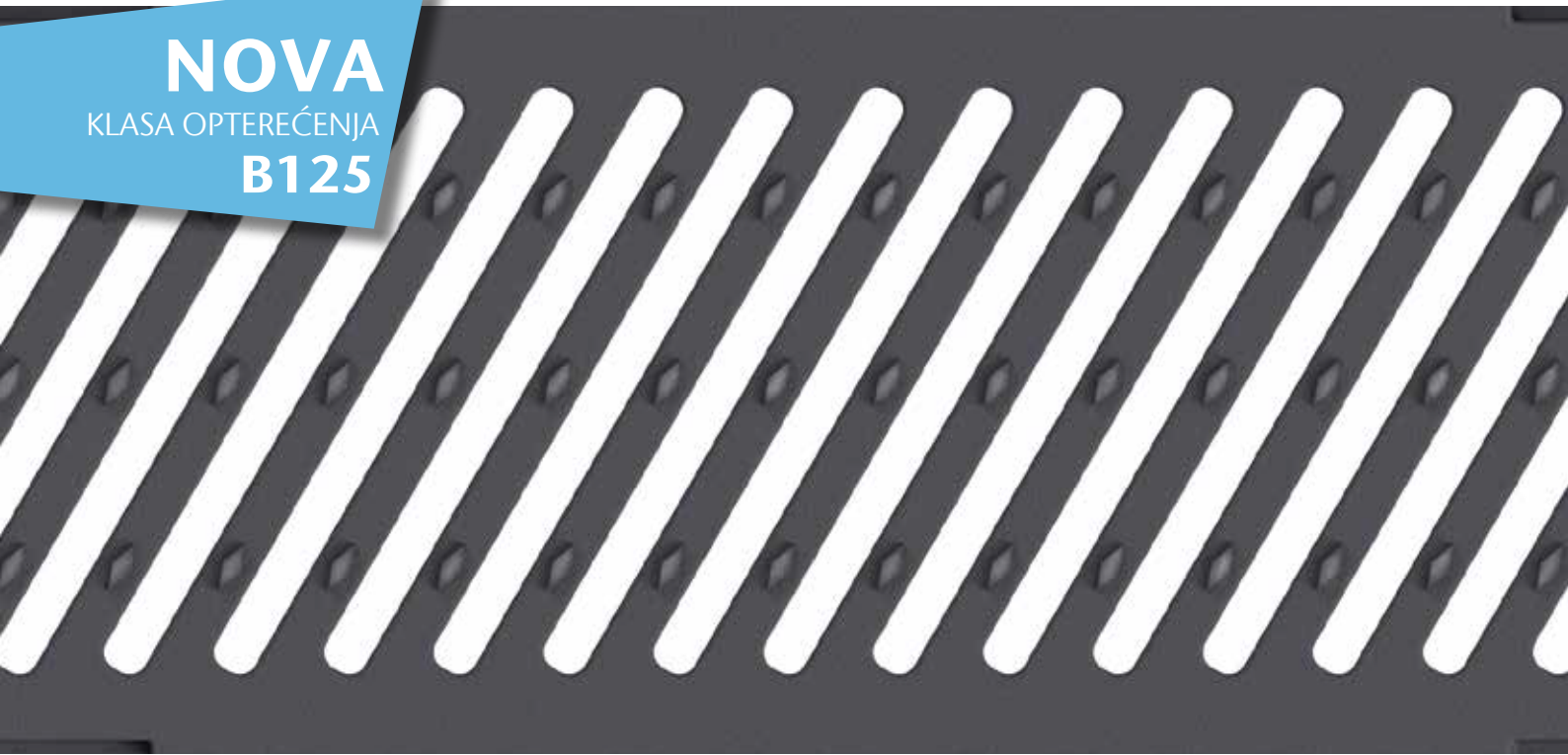

HD-PE
REŠETKA SA PROREZIMA



KLASA A15

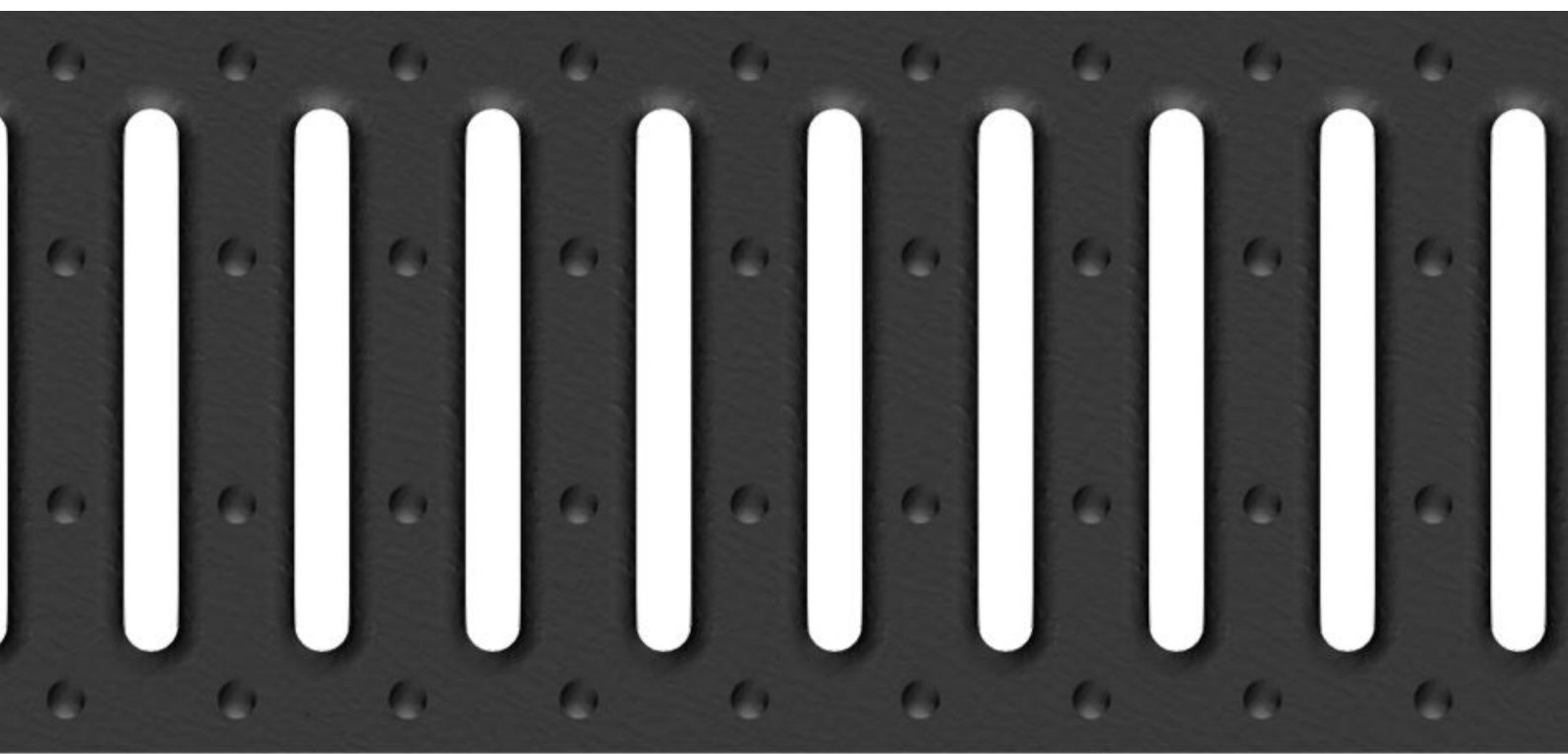

REŠETKA SA PROREZIMA - POCINKOVANI ČELIK



613001 - GARAGE PACK

3 m kanala sa rešetkom od pocinkovanog čelika
+ set vertikalni izliv sa 2 čeona poklopca

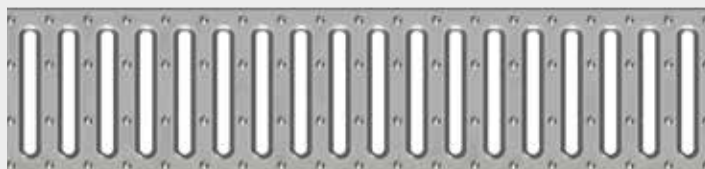

UGAONI ELEMENT - 613200

Rešetka od pocinkovanog čelika

REŠETKA SA "SLIM" PROREZIMA - POCINKOVANI ČELIK



613031 - GARAGE PACK

3 m kanala sa "SLIM" rešetkom od pocinkovanog čelika
+ set vertikalni izliv sa 2 čeona poklopca

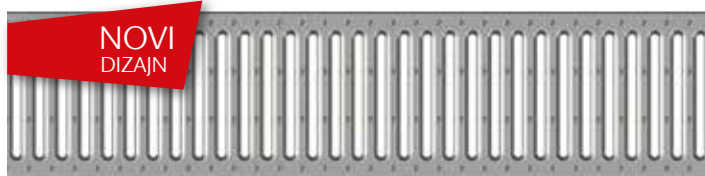

UGAONI ELEMENT - 613207

"SLIM" Rešetka od pocinkovanog čelika

REŠETKA SA PROREZIMA - NERĐAJUĆI ČELIK (INOX)

Sa plavom zaštitnom folijom



613017 - GARAGE PACK

3 m kanala sa rešetkom od nerđajućeg čelika (inox)
+ set vertikalni izliv sa 2 čeona poklopca

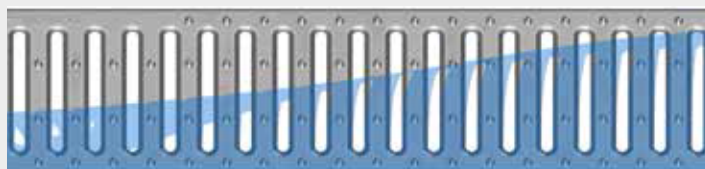

UGAONI ELEMENT - 613204

Rešetka od nerđajućeg čelika (inox) sa plavom zaštitnom folijom

REŠETKA SA "SLIM" PROREZIMA - NERĐAJUĆI ČELIK (INOX)

Sa plavom zaštitnom folijom



613037 - GARAGE PACK

3 m kanala sa "SLIM" rešetkom od nerđajućeg čelika (inox)
+ set vertikalni izliv sa 2 čeona poklopca



UGAONI ELEMENT - 613209

"SLIM" Rešetka od nerđajućeg čelika (inox) sa plavom zaštitnom folijom

500mm REŠETKA - LIVENO GVOŽĐE



613032 - GARAGE PACK

3 m kanala sa 500mm rešetkom od livenog gvožđa + set vertikalni izliv sa 2 čeona poklopca



UGAONI ELEMENT - 613206

Rešetka od livenog gvožđa

HD-PE - REŠETKA SA PROREZIMA



613003 - GARAGE PACK

3 m kanala sa HD-PE rešetkom
+ set vertikalni izliv sa 2 čeona poklopca



UGAONI ELEMENT - 613201

HD-PE rešetka

4ALL Garage Pack

Informacije o proizvodu

- Garage pack sadrži:
 - 3 kanala PP-PE, 3 rešetke, 2 čeona poklopca
 - 1 vertikalni izliv PP-PE sa ø 75/110 mm
- Unutrašnje mere kanala (LxH): 95 x 70 mm
- Rub kanala PP-PE
- Rešetke u klasi opterećenja A 15, B 125
- Integrisani sistem za zaključavanje rešetki



Set: vertikalni izliv + čeoni poklopci

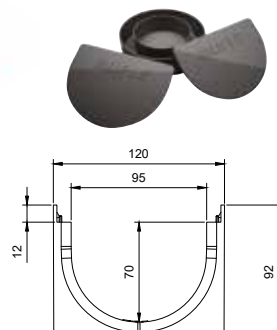

Garage pack: 3 kanala PP-PE, 3 HeelSafe rešetke, 1 vertikalni izliv, 2 čeona poklopca

Tip rešetki	Klasa op.	Prerez [mm]	Dimenzije kanala			Kom/Pal [n.]	Br. art.
			Dužina [mm]	Širina [mm]	Visina [mm]		
1. Rešetka PP-PE	A 15	8	1000	120	92	26	613003
2. Rešetka od pocinkovanog čelika	A 15	8	1000	120	92	26	613001
3. "Slim" rešetka od pocinkovanog čelika	A 15	5	1000	120	92	26	613031
4. Rešetka od nerđajućeg čelika inox AISI 304	A 15	8	1000	120	92	26	613017
5. "Slim" rešetka od nerđajućeg čelika inox AISI 304	A 15	5	1000	120	92	26	613037
6. Rešetka od livenog gvožđa	B 125	6	1000	120	92	26	613032



1

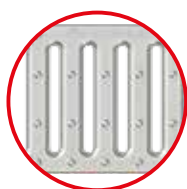

2

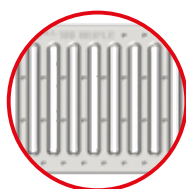

3



4



5



6

Ugaoni element

- Omogućava poprečne spojeve "T" i "L" oblika



Tip rešetke	Klasa op.	Prerez [mm]	Dimenzije ugaonog elementa			Kom/Box [n.]	Br. art.
			Dužina [mm]	Širina [mm]	Visina [mm]		
1. Rešetka PP-PE	A 15	8	145	120	92	20	613201
2. Rešetka od pocinkovanog čelika	A 15	8	145	120	92	20	613200
3. "Slim" rešetka od pocinkovanog čelika	A 15	5	145	120	92	20	613207
4. Rešetka od nerđajućeg čelika inox AISI 304	A 15	8	145	120	92	20	613204
5. "Slim" rešetka od nerđajućeg čelika inox AISI 304	A 15	5	145	120	92	20	613209
6. Rešetka od livenog gvožđa	B 125	6	145	120	92	20	613206

4ALL

Kanal

Informacije o proizvodu

- Kanal PP-PE
- Unutrašnje mere kanala (LxH): 95 x 70 mm
- Rub kanala PP-PE
- Rešetke u klasi opterećenja A 15, B 125
- Integrisani sistem za zaključavanje rešetki

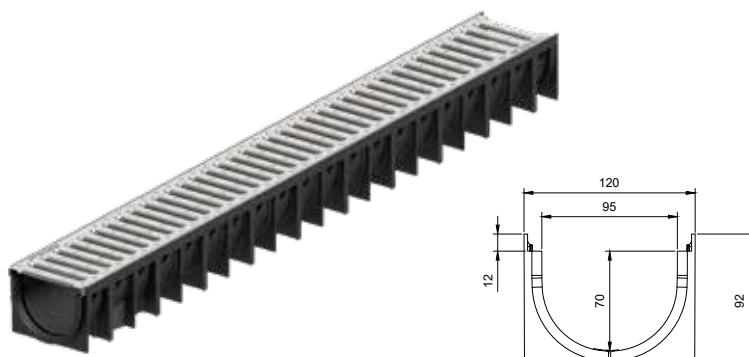

Kanal PP-PE u kompletu sa montiranom rešetkom

Tip rešetke	Klasa op.	Prerez [mm]	Dimenzije kanala			Kom/Pal [n.]	Br. art.
			Dužina [mm]	Širina [mm]	Visina [mm]		
1. Rešetka PP-PE	A 15	8	1000	120	92	72	613005
2. Rešetka od pocinkovanog čelika	A 15	8	1000	120	92	72	613000
3. "Slim" rešetka od pocinkovanog čelika	A 15	5	1000	120	92	72	613038
4. Rešetka od nerđajućeg čelika inox AISI 304	A 15	8	1000	120	92	72	613016
5. "Slim" rešetka od nerđajućeg čelika inox AISI 304	A 15	5	1000	120	92	72	613040
6. Rešetka od livenog gvožđa	B 125	6	1000	120	92	72	613030



1

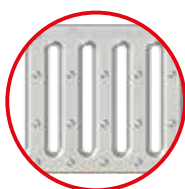

2

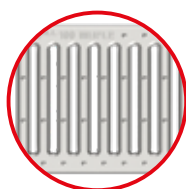

3



4



5



6

Set: vertikalni izliv + 2 čeona poklopca

- 2 čeona poklopca PP-PE
- 1 vertikalni izliv PP-PE sa $\varnothing 75/110$ mm



Opis	Kom/Box [n.]	Br. art.
1. Set vertikalni izliv + čeoni poklopci	50	513200

Ugaoni element

- Pogledajte informacije na prethodnoj stranici



-
- Linijsko odvodnjavanje
 - Ulični i mostni slivnici
 - Šaht poklopci
 - Odvodnjavanje u komercijalnim kuhinjama i prehrambenoj industriji
 - Cevni sistemi
 - Odvodnjavanje krovova, terasa i fasada
 - Unutrašnji liveno gvozdeni slivnici
 - Odvodnjavanje u kupatilima
 - Separatori
 - Infiltracija i upravljanje vodama
 - Prepumpna okna
 - Samostojeća prepumpna postrojenja
 - Pejzažna arhitektura
 - Zaštita vodozemaca
 - Proizvodi za kuće i dvorišta
-



ACO građevinski elementi d.o.o

Srbija, III Industrijska zona bb
22314 Krnješevci, Stara Pazova
Tel. +381 22 811 580
Fax. +381 22 811 590
aco@aco.rs
www.aco.rs