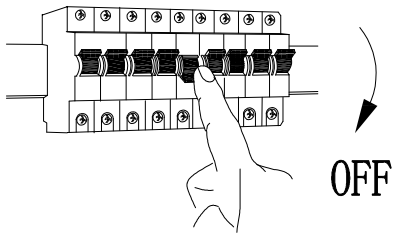
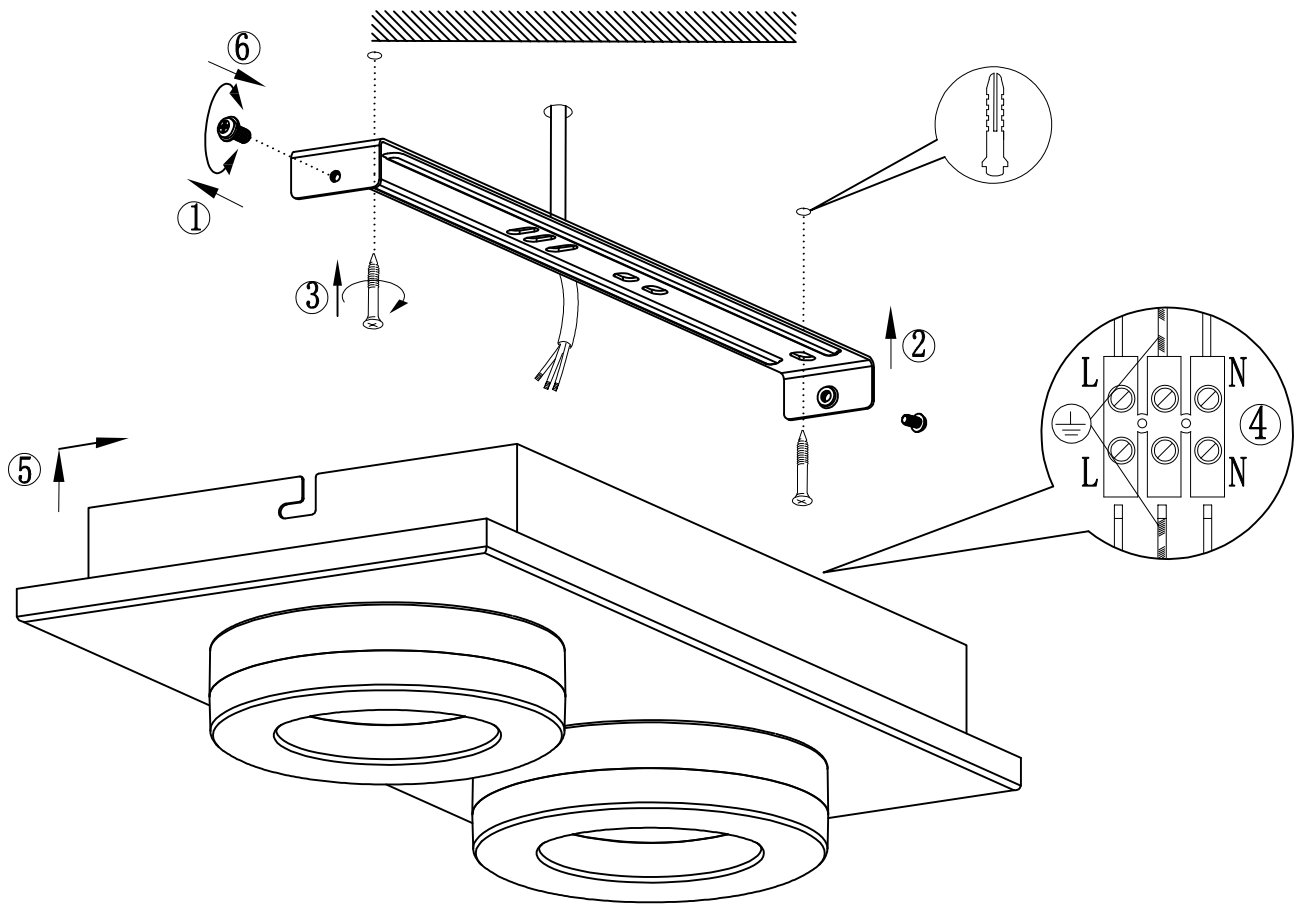
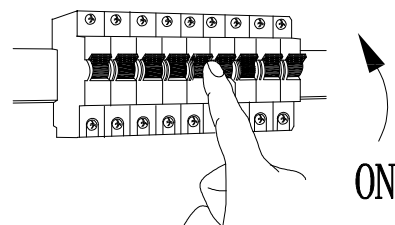

A**B****C**

BLA32567
www.eglo.com