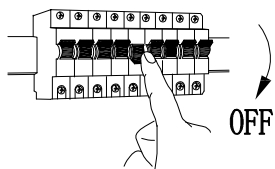
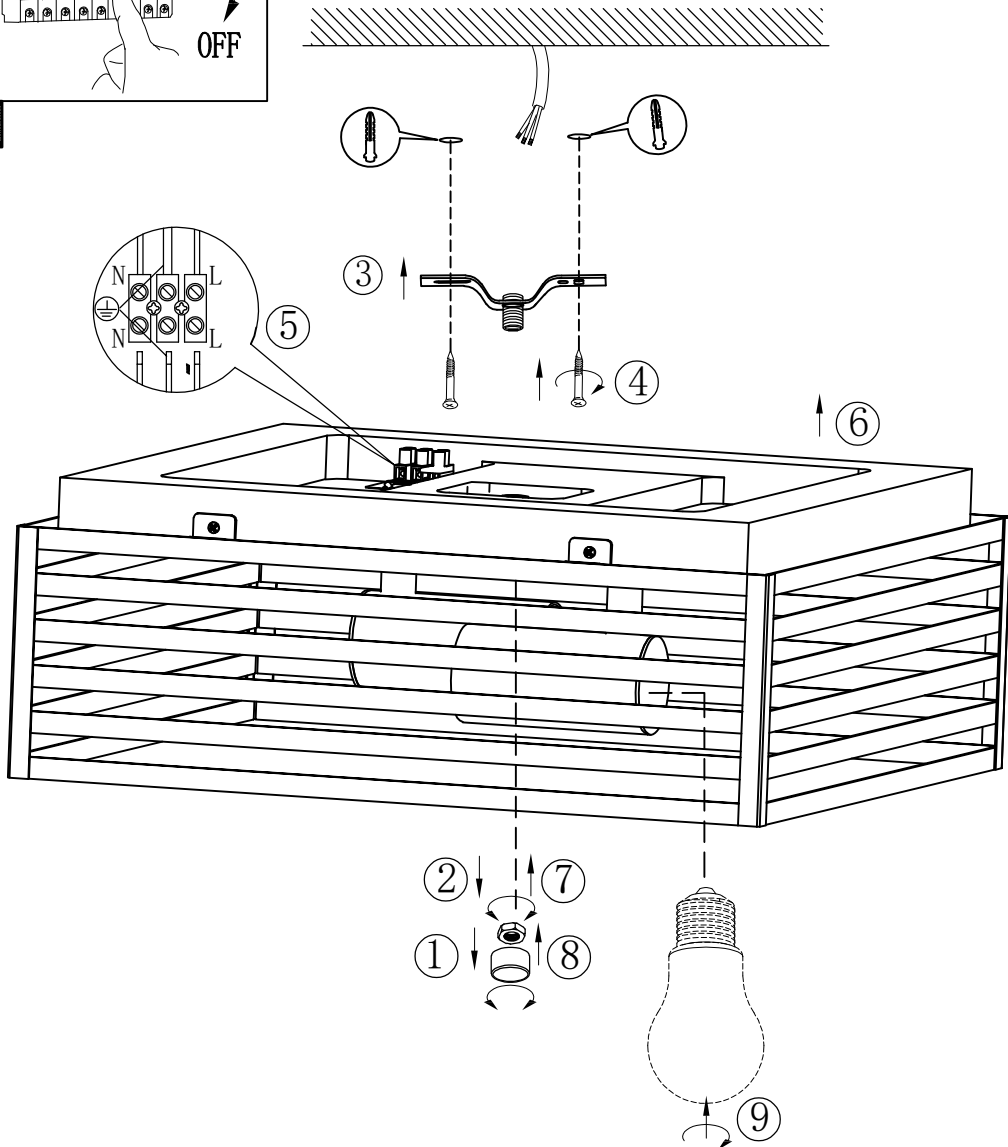
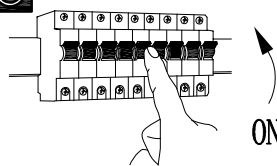

**A****B****C**

BLA390163

www.eglo.com