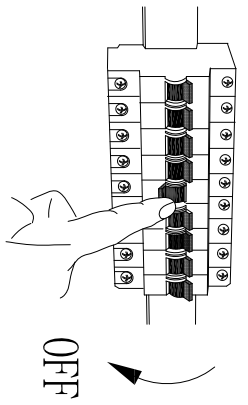
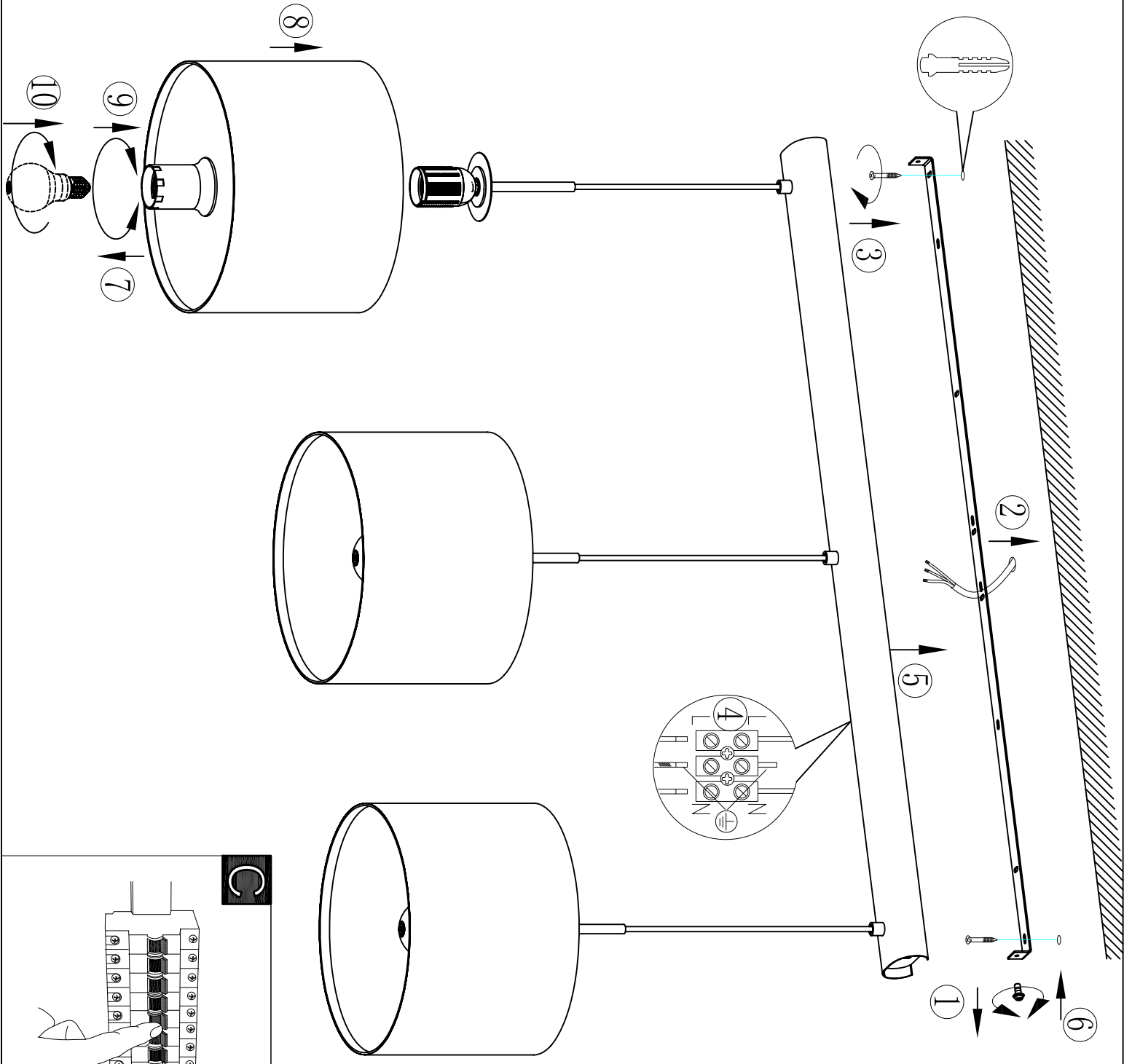
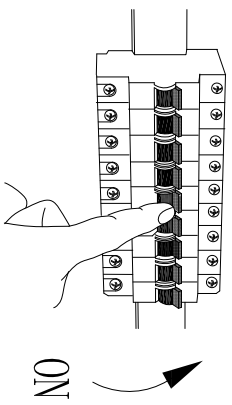

A**B****C**

BLA39555
www.eglo.com