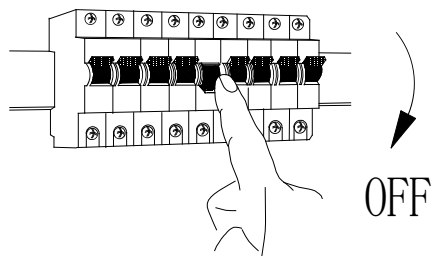
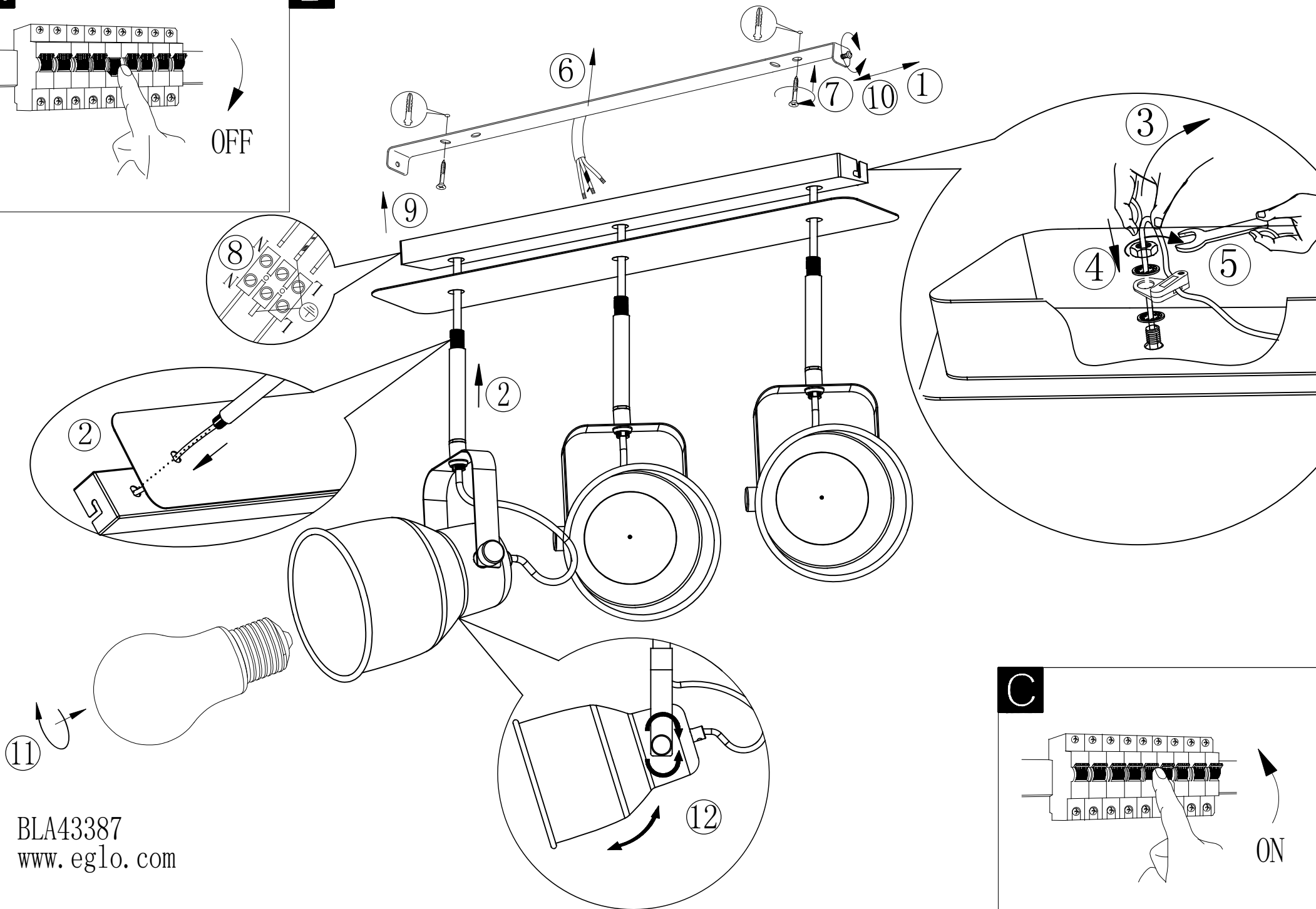
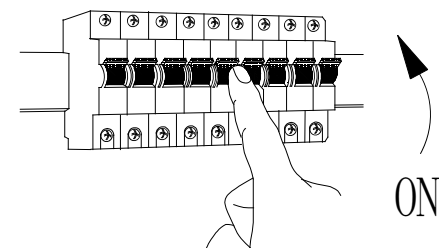

A**B****C**

BLA43387
www.eglo.com