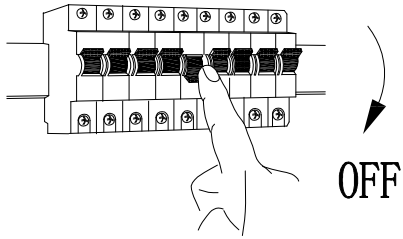
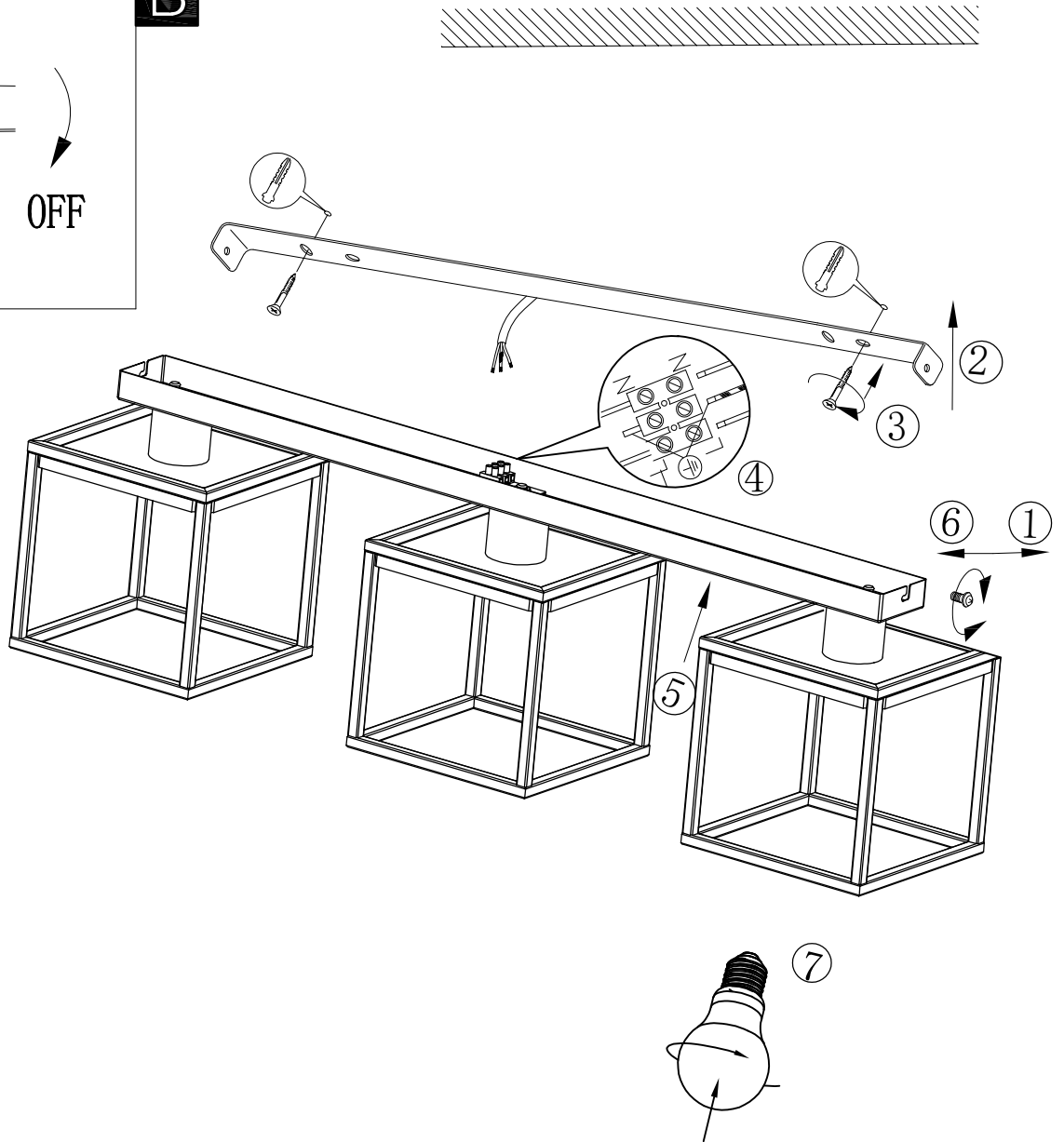
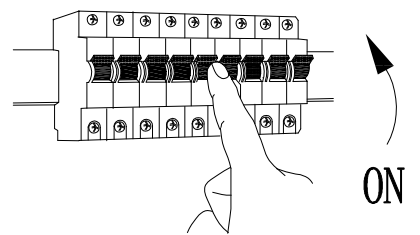

A**B****C**

BLA99856
www.eglo.com