



### Osnovne informacije

Grupa proizvoda	Altistart 22
Tip proizvoda ili komponente	Soft starter
Namena proizvoda	Asinhroni motori
Specifične primene proizvoda	Pumpe i ventilatori
Ime komponente	ATS22
Broj faza mreže	Trofazne
[us] nazivni napon	230...440 V - 15...10 %
Snaga motora kw	45 KW 230 V 90 KW 400 V 90 KW 440 V
Struja fabričkog podešavanja	162 A
Snaga disipacije u w	91 W za standardne aplikacije
Kategorija upotrebe	AC-53A
Tip pokretanja	Pokretanje sa kontrolom momenta (struja ograničena na 3.5 In)
Icl pokretača	170 A za direktno povezivanje sa motorom za standardne aplikacije
Ip stepen zaštite	IP00

### Dopunske informacije

Način spajanja	Sa hladnjakom
Dostupna funkcija	Interni bypass
Ograničenje napona napajanja	195...484 V
Frekvencija napajanja	50...60 Hz - 10...10 %
Mrežna frekvencija	45...66 Hz
Povezivanje uređaja	Redno sa namotajima motora povezanog u trougao Direktno povezivanje sa motorom
Napon upravljačkog kola	230 V - 15...10 % 50/60 Hz
Potrošnja upravljačkog kola	20 W
Broj digitalnih izlaza	2
Tip digitalnih izlaza	Relejni izlazi R1 230 V u radu,alarm,prorada zašt.,zaust.,nije zaustavljen,u fazi pokret.,spreman za rad C/O Relejni izlazi R2 230 V u radu,alarm,prorada zašt.,zaust.,nije zaustavljen,u fazi pokret.,spreman za rad C/O
Minimalna struja preklapanja	100 mA pri 12 V DC (relejni izlazi)
Maksimalna struja preklapanja	5 A 250 V AC rezistivno 1 relejni izlazi 5 A 30 V DC rezistivno 1 relejni izlazi 2 A 250 V AC induktivno 0,4 20 milisekundi relejni izlazi 2 A 30 V DC induktivno 7 milisekundi relejni izlazi
Broj digitalnog ulaza	3
Tip digitalnih ulaza	(LI1, LI2, LI3) logika, 5 mA 4.3 kΩ
Napon digitalnog ulaza	24 V <= 30 V
Logika digitalnog ulaza	Pozitivna logika LI1, LI2, LI3 u stanju 0: < 5 V i <= 2 mA u stanju 1: > 11 V, >= 5 mA
Struja izlaza	0.4...1 Icl podesivi
Ulaz za ptc sondu	750 Ω
Protokol komunikacionog porta	Modbus
Tip priključka	1 RJ45

Komunikaciona veza	Serijska veza
Fizički interfejs	RS485 multidrop
Brzina prenosa	4800, 9600 ili 19200 bps
Instalirani uređaj	31
Tip zaštite	Gubitak faze: napajanje Termička zaštita: motor Termička zaštita: pokretač
Označavanje	CE
Tip hlađenja	Ventilatorom za strujanje vazduha
Radni položaj	Vertikalno +/- 10 stepeni
Visina	356 mm
Širina	150 mm
Dubina	229,5 mm
Masa proizvoda	18 kg
Motor power range AC-3	30...50 KW pri 200...240 V trofazne 55...100 kW pri 380...440 V trofazne
Tip motornog pokretača	Soft starter

## Okruženje

Elektromagnetna kompatibilnost	Licencu nivo A u skladu sa IEC 60947-4-2 Sinusni talasi koji se eksponencijalno smanjuju nivo 3 u skladu sa IEC 61000-4-12 Elektrostatička pražnjenja nivo 3 u skladu sa IEC 61000-4-2 Otpornost na električne prelaze nivo 4 u skladu sa IEC 61000-4-4 Otpornost na emitovane radio električne interferencije nivo 3 u skladu sa IEC 61000-4-3 Impuls napona/struje nivo 3 u skladu sa IEC 61000-4-5
Standardi	EN/IEC 60947-4-2
Sertifikacija proizvoda	CSA C-Tick GOST UL CCC
Otpornost na vibracije	1 gn (f= 13...200 Hz) u skladu sa EN/IEC 60068-2-6 1.5 mm (f= 2...13 Hz) u skladu sa EN/IEC 60068-2-6
Otpornost na udare	15 gn za 11 milisekundi u skladu sa EN/IEC 60068-2-27
Nivo buke	56 dB
Stepen zaprljanosti	Nivo 2 u skladu sa IEC 60664-1
Relativna vlažnost	0...95 % bez kondenzacije ili kapljica vode u skladu sa EN/IEC 60068-2-3
Temperatura okoline za rad	-10...40 °C (bez smanjenja karakteristika) 40...60 °C (sa smanjenjem vrednosti struje 2.2 % na °C)
Temperatura okoline za skladištenje	-25...70 °C
Nadmorska visina za rad uređaja	<= 1000 m bez smanjenja karakteristika > 1000...< 2000 m sa smanjenjem vrednosti struje od 2.2 % na dodatnih 100 m

## Pakovanje

Unit Type of Package 1	PCE
Number of Units in Package 1	1
Package 1 Height	25,0 cm
Package 1 Width	33,0 cm
Package 1 Length	41,0 cm
Package 1 Weight	13,218 kg
Unit Type of Package 2	P06
Number of Units in Package 2	4
Package 2 Height	73,5 cm
Package 2 Width	80,0 cm
Package 2 Length	60,0 cm
Package 2 Weight	64,064 kg

## Održivost ponude

Status održive ponude	Green Premium proizvod
Propis REACh	<a href="#">REACH Deklaracija</a>
EU RoHS direktiva	Proaktivna usaglašenost (proizvod nije u zakonskom okviru direktive EU RoHS) <a href="#">EU RoHS deklaracija</a>
Bez žive	Da
Informacije o RoHS izuzecima	<a href="#">Da</a>
RoHS regulativa za Kinu	<a href="#">RoHS Deklaracija Za Kinu</a>
Izjava o zaštiti okoliša	<a href="#">Profil Ekološke Prihvatljivosti Proizvoda</a>
Profil cirkularnosti	<a href="#">Informacije O Kraju Radnog Veka</a>
WEEE	Ovaj proizvod je na tržištima Evropske unije neophodno odložiti u skladu sa specifičnim smernicama za prikupljanje otpada i nikako ne sme da dospe u kontejnere za otpatke.

## Ugovorna garancija

Garancija	18 meseci
-----------	-----------



## Precautions

### Standards

The Altistart 22 soft starter is compliant with pollution Degree 2 as defined in NEMA ICS1-1 or IEC 60664-1.

For environment pollution degree 3, install the Altistart 22 soft starter inside a cabinet type 12 or IP54.

### **⚠ DANGER**

HAZARD OF ELECTRIC SHOCK, EXPLOSION, OR ARC FLASH

ATS22 soft starters are open devices and must be mounted in a suitable enclosure.

Failure to follow these instructions will result in death or serious injury.

### Air Circulation

Leave sufficient free space to help the air required for cooling purposes to circulate from the bottom to the top of the unit.

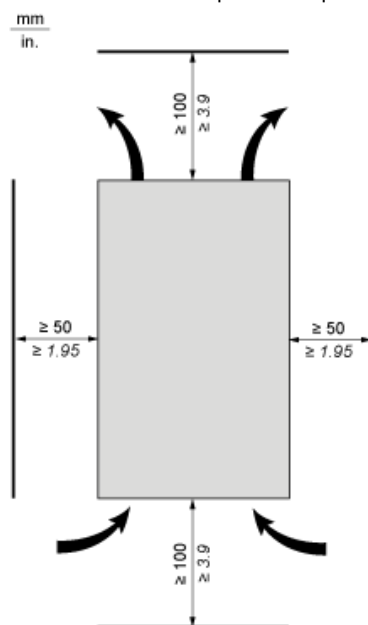

### Overheating

To avoid the soft starter to overheat, respect the following recommendations:

- Mount the Altistart 22 Soft Starter within  $\pm 10^\circ$  of vertical.
- Do not locate the Altistart 22 Soft Starter near heat radiating elements.
- Electrical current through the Altistart 22 Soft Starter will result in heat losses that must be dissipated into the ambient air immediately surrounding the soft starter. To help prevent a thermal fault, provide sufficient enclosure cooling and/or ventilation to limit the ambient temperature around the soft starter.
- If several soft starters are installed in a control panel, arrange them in a row. Do not stack soft starters. Heat generated from the bottom soft starter can adversely affect the ambient temperature around the top soft starter.

### Mounting

## Connection Between the Fan and the Altistart 22 Soft Starter

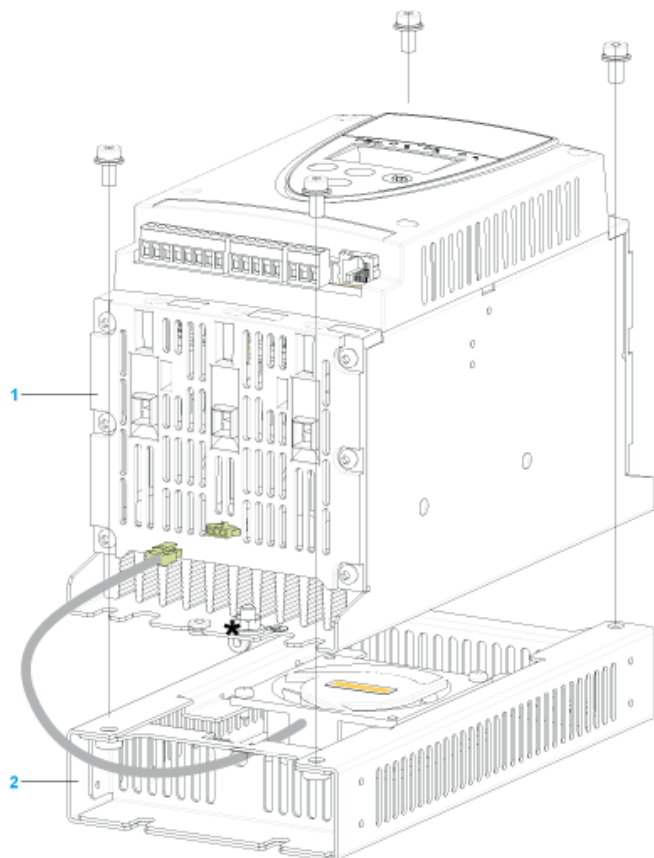

- 1 Altistart 22 Soft Starter
- 2 Fan

## Wall mounted or Floor-standing Enclosure with IP 23 Degree of protection

---

### Introduction

To help proper air circulation in the soft starter, grilles and forced ventilation can be installed.

### Ventilation Grilles

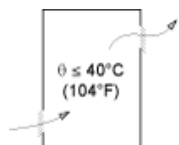

### Forced Ventilation Unit

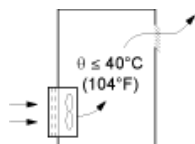

Power Terminal

Bar Style

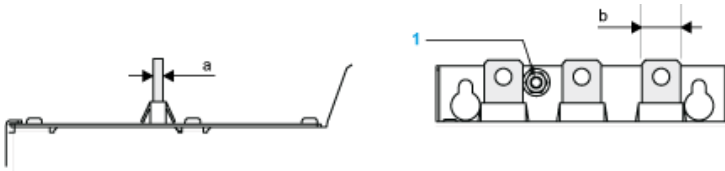

Power supply and output to motor	Bar	b	20 mm (0.79 in)
a	5 mm (0.2 in)		
Bolt	M8 (0.31 in)		
Cable and protective cover	Size	95 mm <sup>2</sup>	
Gauge	250 MCM		
Protective cover	LA9F702		
Tightening torque	18 N.m		
157.5 lb.in			

Power connections, minimum required wiring section

IEC cable mm <sup>2</sup> (Cu 70°C/158°F) (1)	UL cable AWG (Cu 75°C/167°F) (1)
70	4/0

230 Vac control, logic Inputs (LI) 24 Vdc, 3-wire control

With Line Contactor, Freewheel or Controlled Stop

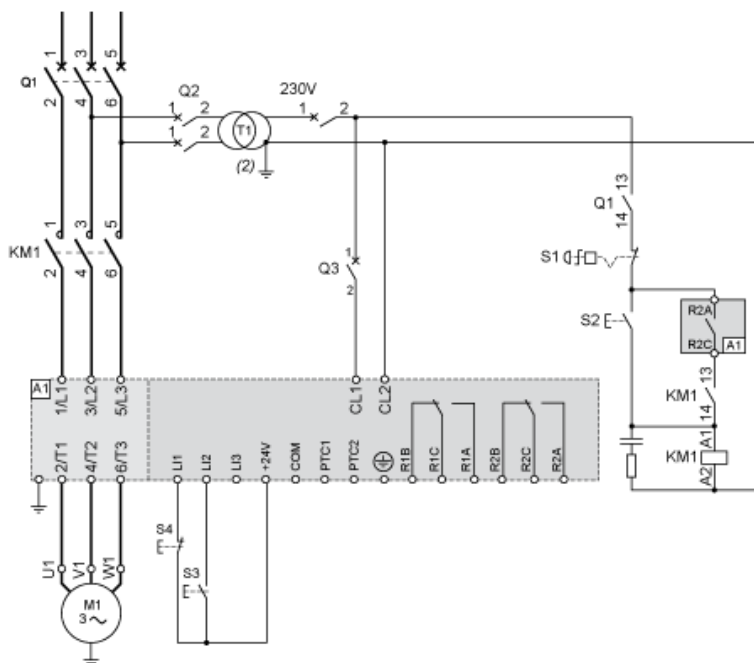

230 Vac control, logic Inputs (LI) 24 Vdc, 2-wire control, freewheel stop

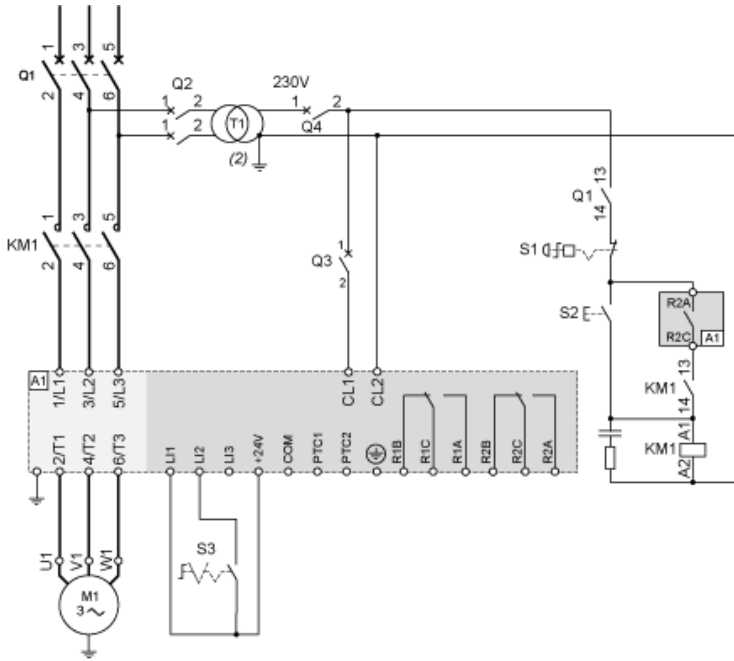

## Connection in the motor delta winding in series with each winding

### Wiring

ATS22 soft starters connected to motors with the delta connections can be inserted in series in the motor windings.

The following wiring requires particular attention. It is documented in the Altistart 22 Soft start - soft stop unit user manual. Please contact Schneider Electric commercial organisation for further informations.

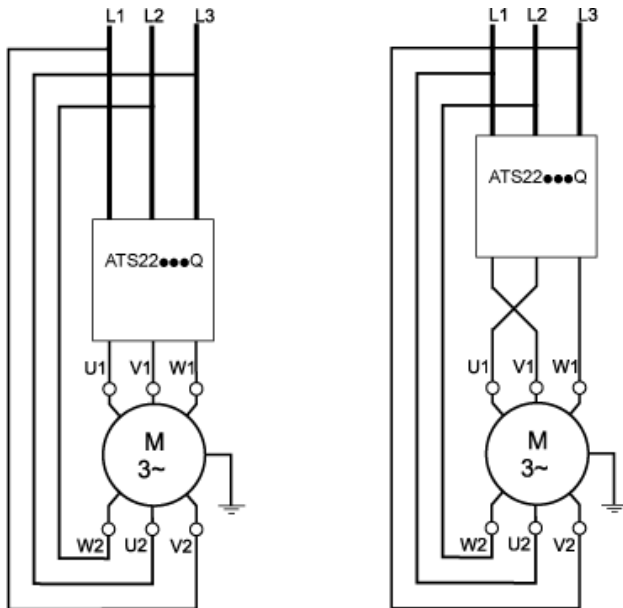

### Example

A 400 V - 110 kW motor with a line current of 195 A (nominal current for the delta connection). The current in each winding is equal to  $195/1.5$  or 130 A. The rating is determined by selecting the soft starter with a permanent nominal current (ICL) just above this current.



Motor Thermal Protection - Cold Curves

Curves

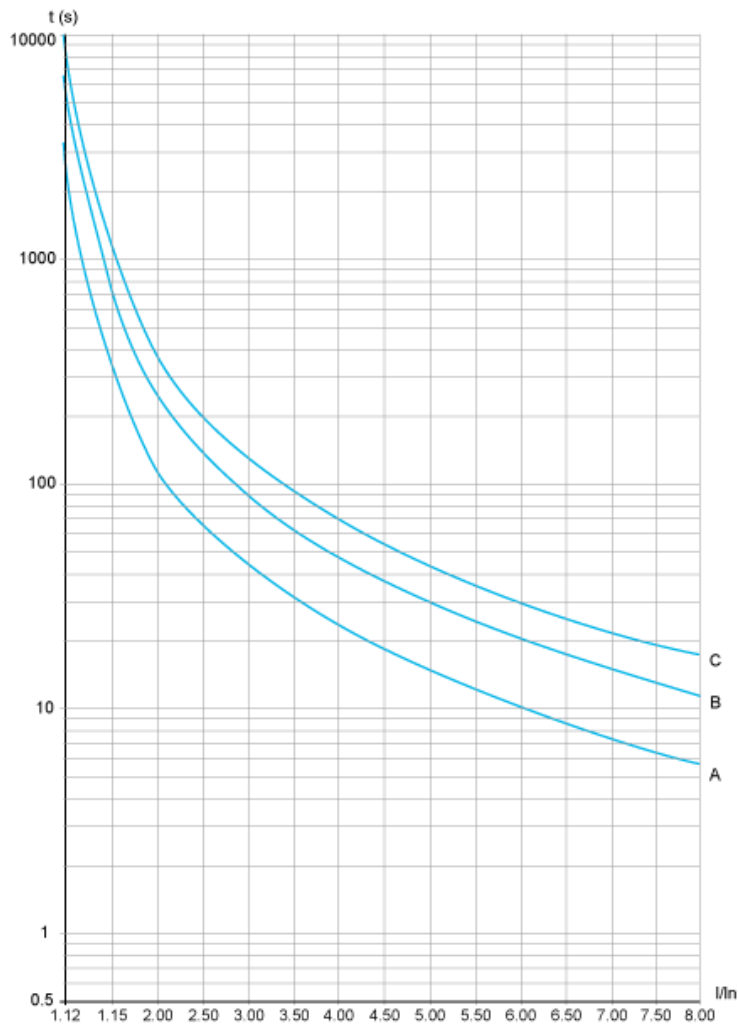

- A Class 10
- B Class 20
- C Class 30

Trip time for a Standard Application (Class 10)

3.5 In
32 s

Trip time for a Severe Application (Class 20)

3.5 In
63 s

Trip time for a Severe Application (Class 30)

3.5 In
95 s

Curves

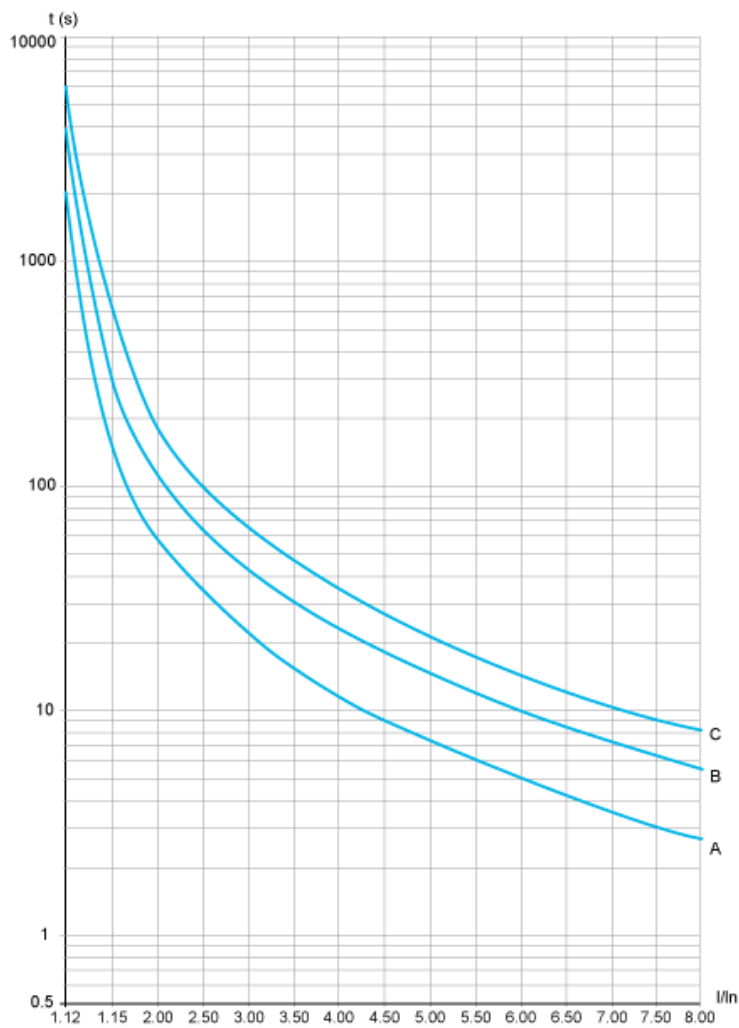

- A Class 10
- B Class 20
- C Class 30

Trip time for a Standard Application (Class 10)

3.5 In
16 s

Trip time for a Severe Application (Class 20)

3.5 In
32 s

Trip time for a Severe Application (Class 30)

3.5 In
48 s