



Osnovne informacije

Grupa proizvoda	Harmony Timer Relays
Tip proizvoda ili komponente	Multifunction relay
Tip digitalnog izlaza	Releji
Širina	17,5 mm
Kratko ime uređaja	RE17R
Tip kašnjenja	Power on-delay On-delay and off-delay Interval Kašnjenje isključenja Symmetrical flashing
Opseg vremenskog kašnjenja	1...10 s 6...60 s 10...100 h 1...10 min 1...10 h 0.1...1 s 6...60 min
Nazivna izlazna struja	8 A

Dopunske informacije

Tip kontakata i sastav	1 C/O
Materijal kontakata	Bez kadmijuma
Visina	90 mm
Dubina	72 mm
Način upravljanja	Izborni prekidač prednji panel
[us] nazivni napon napajanja	12 V AC/DC 50/60 Hz
Opseg napona	0.9...1.2 Us
Frekvencija napajanja	50...60 Hz +/- 5 %
Release of input voltage	5 V
Povezivanje - priključci	Vijčani priključci, 1 x 0.5...1 x 3.3 mm ² (AWG 20...AWG 12) jednožični bez kablovskog završetka Vijčani priključci, 2 x 0.5...2 x 2.5 mm ² (AWG 20...AWG 14) jednožični bez kablovskog završetka Vijčani priključci, 1 x 0.2...1 x 2.5 mm ² (AWG 24...AWG 14) fleksibilni sa kablovskim završetkom Vijčani priključci, 2 x 0.2...2 x 1.5 mm ² (AWG 24...AWG 16) fleksibilni sa kablovskim završetkom
Moment pritezanja	0,6...1 N.m u skladu sa IEC 60947-1
Materijal kućišta	Samogasivi
Tačnost ponavljanja	+/- 0.5 % u skladu sa IEC 61812-1
Temperaturni drift	+/- 0.05 %/°C
Naponski drift	+/- 0.2 %/V
Podešavanje tačnosti kašnjenja	+/- 10 % od pune skale pri 25 °C u skladu sa IEC 61812-1
Control signal pulse width	100 ms sa opterećenjem u paraleli tipično 30 ms tipično
Otpornost izolacije	100 MOhm pri 500 V DC u skladu sa IEC 60664-1
Vreme reseta	120 milisekundi pri isključenju tipično
Faktor opterećenja	100 %
Snaga potrošnje u va	0...0,7 VA pri 12 V AC
Maksimalna potrošnja u w	0,5 W pri 12 V DC
Minimalna struja preklapanja	10 mA pri 5 V DC

Maksimalna struja preklapanja	8 A AC/DC
Maksimalni napon preklapanja	250 V AC
Prekidna moć	2000 VA
Operating frequency	10 Hz
Električna trajnost	100000 ciklusa za rezistivno opterećenje (8 A pri 250 V AC maksimum)
Mehanička trajnost	10000000 ciklusa
Dielektrična snaga	2,5 kV 1 mA/1 minut 50 Hz u skladu sa IEC 61812-1
[uimp] nazivni podnosivi impulsni napon	5 kV tokom 1.2/50 µs
Power on delay	100 milisekundi
Označavanje	CE
Puzna staza	4 kV/3 u skladu sa IEC 60664-1
Sigurnosni podaci o pouzdanosti	MTTFd = 296.8 godina B10d = 270000
Pozicija montaže	Bilo koja pozicija u odnosu na normalnu vertikalnu montažnu ploču
Držač za montažu	35 mm DIN šina u skladu sa EN/IEC 60715
Lokalna signalizacija	LED indikator za kontinualno: relej pod naponom, vremenska funkcija se ne izvršava trenutno LED indikator 80 % ON i 20 % OFF za treperenje: izvršavanje zadate funkcije u toku LED indikator 5 % ON i 95 % OFF za treperenje:kelem nije pod naponom,vremenska f-ja nije aktivna (izuzev Di-D,Li-L)
Masa proizvoda	0,07 kg
Vrsta kašnjenja	A, Ac, At, B, Bw, C, D, Di, H, Ht
Funkcionalnost	Više funkcija
Kompatibilnost	RE17

Okruženje

Otpornost na mikroprekide	20 milisekundi
Standardi	2006/95/EC 2004/108/EC EN 61000-6-4 EN 61000-6-1 EN 61000-6-3 IEC 61812-1 EN 61000-6-2
Sertifikacija proizvoda	CSA GL cULus
Temperatura okoline za skladištenje	-30...60 °C
Temperatura okoline za rad uređaja	-20...60 °C
Ip stepen zaštite	IP20 u skladu sa IEC 60529 (priključni blok) IP40 u skladu sa IEC 60529 (kućište) IP50 u skladu sa IEC 60529 (prednji panel)
Otpornost na vibracije	20 m/s ² (f= 10...150 Hz) u skladu sa IEC 60068-2-6
Otpornost na udare	15 gn za 11 milisekundi u skladu sa IEC 60068-2-27
Relativna vlažnost	93 % bez kondenzacije u skladu sa IEC 60068-2-30
Elektromagnetna kompatibilnost	Test otpornosti elektrostatičkog pražnjenja: (u kontaktu) nivo 3 test nivo: 6 kV u skladu sa IEC 61000-4-2 Test otpornosti elektrostatičkog pražnjenja: (u vazduhu) nivo 3 test nivo: 8 kV u skladu sa IEC 61000-4-2 Osetljivost na elektromagnetna polja: (80 MHz do 1 GHz) nivo 3 test nivo: 10 V/m u skladu sa IEC 61000-4-3 Test otpornosti električnih brzih prelaza (EFT)/kratak signal: (spojnica za kapacitivno povezivanje) nivo 3 test nivo: 1 kV u skladu sa IEC 61000-4-4 Test otpornosti električnih brzih prelaza (EFT)/kratak signal: (direktno) nivo 3 test nivo: 2 kV u skladu sa IEC 61000-4-4 1.2/50 µs test otpornosti udarnog talasa: (diferencijalni mod) nivo 3 test nivo: 1 kV u skladu sa IEC 61000-4-5 1.2/50 µs test otpornosti udarnog talasa: (asimetrični napon) nivo 3 test nivo: 2 kV u skladu sa IEC 61000-4-5 Radio smetnje emisije vezane sa vodovima: (0.15...80 MHz) nivo 3 test nivo: 10 V u skladu sa IEC 61000-4-6 Test otpornosti propada i prekida napona: (1 ciklus) test nivo: 0 % u skladu sa IEC 61000-4-11 Test otpornosti propada i prekida napona: (25/30 ciklusa) test nivo: 70 % u skladu sa IEC 61000-4-11 Licencu: klasa B u skladu sa EN 55022

Pakovanje

Unit Type of Package 1	PCE
Number of Units in Package 1	1
Package 1 Height	2,8 cm
Package 1 Width	8,0 cm
Package 1 Length	9,8 cm
Package 1 Weight	80,0 g
Unit Type of Package 2	S02
Number of Units in Package 2	40
Package 2 Height	15,0 cm
Package 2 Width	30,0 cm
Package 2 Length	40,0 cm
Package 2 Weight	3,475 kg

Održivost ponude

Status održive ponude	Green Premium proizvod
Propis REACh	REACH Deklaracija
EU RoHS direktiva	Proaktivna usaglašenost (proizvod nije u zakonskom okviru direktive EU RoHS) EU RoHS deklaracija
Bez žive	Da
Informacije o RoHS izuzecima	Da
RoHS regulativa za Kinu	RoHS Deklaracija Za Kinu
Izjava o zaštiti okoliša	Profil Ekološke Prihvatljivosti Proizvoda
Profil cirkularnosti	Informacije O Kraju Radnog Veka

Width 17.5 mm

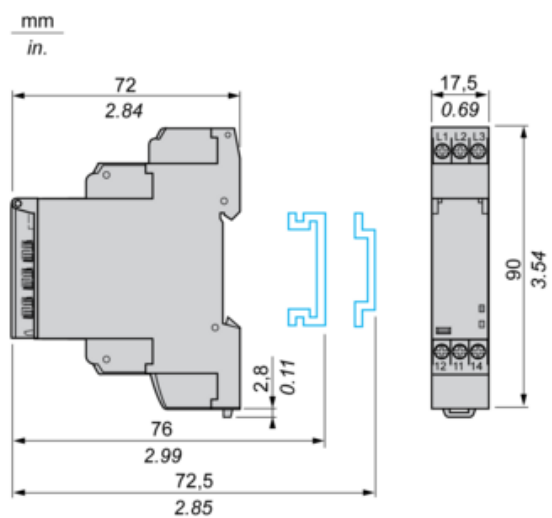

Internal Wiring Diagram

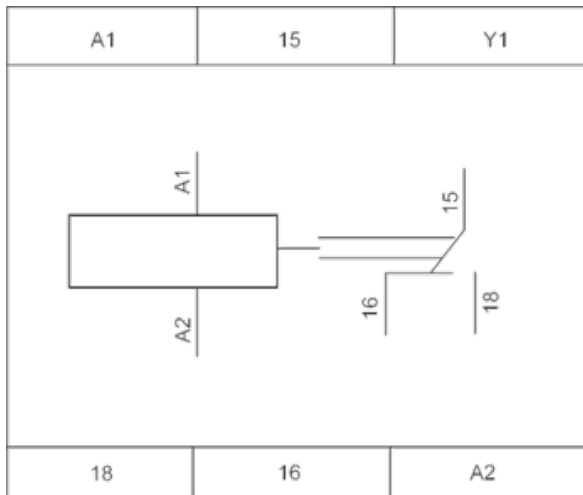

Wiring Diagram

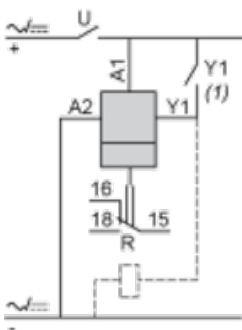

1) Contact Y1:

- Control for functions B, C, Ac, Bw, Ad, Ah, N, O, W, T, Tt.
- Partial stop for functions At, Ht and Pt.
- Function D if Di selected.
- Not used for functions A, H and P.

Function A : Power on Delay Relay

Description

The timing period T begins on energisation. After timing, the output(s) R close(s). The second output can be either timed or instantaneous.

Function: 1 Output



Function: 2 Outputs

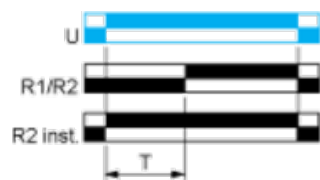

2 timed outputs (R1/R2) or 1 timed output (R1) and 1 instantaneous output (R2 inst.)

Function Ac: On-Delay & Off-Delay with Control Signal

Description

After energisation of power supply and energization of Y1 causes the timing period T to start.

At the end of this timing period, the output(s) R close(s).

When deenergization of Y1, the timing T starts.

At the end of this timing period T, the output(s) R revert(s) to its/their initial position.

The second output (R2) can be either timed (when set to "TIMED") or instantaneous (when set to "INST").

Function: 1 Output

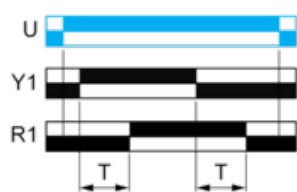

Function: 2 Outputs

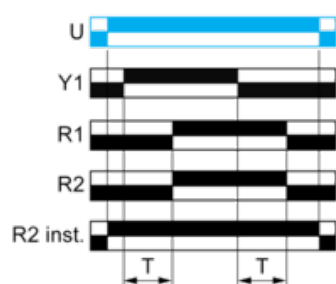

Function At : Power on Delay Relay (Summation) with Control Signal

Description

After power-up, the first opening of control contact C starts the timing. Timing can be interrupted each time control contact closes. When the cumulative total of time periods elapsed reaches the pre-set value T, the output relay closes.

Function: 1 Output

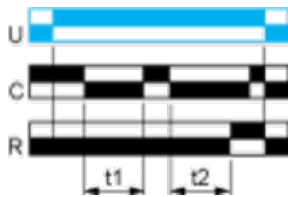

$$T = t1 + t2 + \dots$$

Function B : Interval Relay with Control Signal

Description

After power-up, pulsing or maintaining control contact C starts the timing T. The output R closes for the duration of the timing period T then reverts to its initial state.

Function: 1 Output

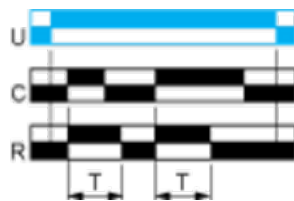

Function Bw : Double Interval Relay with Control Signal

Description

On closing and opening of control contact C, the output R closes for the duration of the timing period T.

Function: 1 Output



Function C : Off-Delay Relay with Control Signal

Description

After power-up and closing of the control contact C, the output R closes. When control contact C re-opens, timing T starts. At the end of the timing period, the output(s) R revert(s) to its/their initial state. The second output can be either timed or instantaneous.

Function: 1 Output

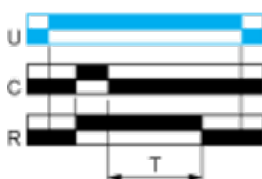

Function: 2 Outputs

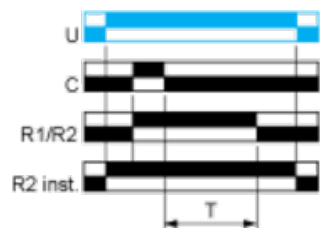

2 timed outputs (R1/R2) or 1 timed output (R1) and 1 instantaneous output (R2 inst.)

Function D: Symmetrical Flashing Relay (Starting Pulse Off)

Description

On energisation of power supply, output(s) R starts at its/their initial state for timing duration T then change(s) to output(s) R close(s) for the same timing duration T. This cycle is repeated indefinitely until power supply removal. Specially for RE17*, RE22R2AMU, RE22R2MMW, RE22R2MMU, RE22R2MJU, this D function can only be initiated by energizing Y1 permanently. The second output (R2) can be either timed (when set to "TIMED") or instantaneous (when set to "INST").

Function: 1 Output

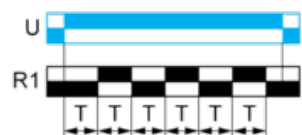

Function: 2 Outputs

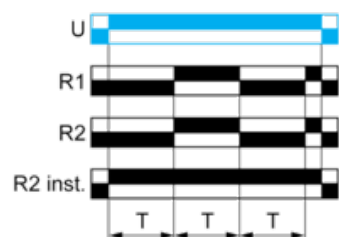

Function: 1 Output with Retrigger / Restart Control

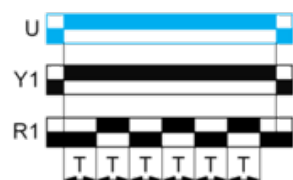

Function: 2 Output with Retrigger / Restart Control

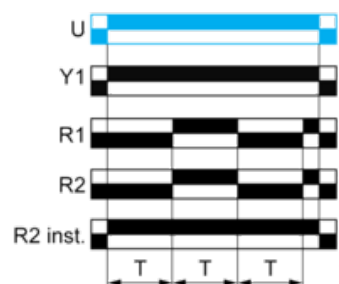

Function Di : Symmetrical Flasher Relay (Starting Pulse On)

Description

Repetitive cycle with two timing periods T of equal duration, with output(s) R changing state at the end of each timing period T. The second output can be either timed or instantaneous.

Function: 1 Output



Function: 2 Outputs

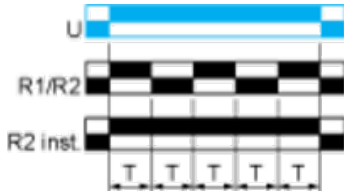

2 timed outputs (R1/R2) or 1 timed output (R1) and 1 instantaneous output (R2 inst.)

Function H : Interval Relay

Description

On energisation of the relay, timing period T starts and the output(s) R close(s). At the end of the timing period T, the output(s) R revert(s) to its/their initial state. The second output can be either timed or instantaneous.

Function: 1 Output



Function: 2 Outputs

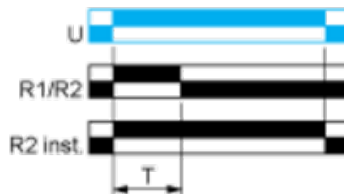

2 timed outputs (R1/R2) or 1 timed output (R1) and 1 instantaneous output (R2 inst.)

Function Ht: Interval Relay & With Pause / Summation Control

Description

On energisation of power supply, output(s) R close(s) and timing period T starts.

The timing can be interrupted / paused each time X1 energizes.

When the cumulative total of time periods elapsed reaches the pre-set value T, the output(s) R revert(s) to its/their initial state. Reenergization of X1 will also cause output(s) R close(s) if the time has elapsed and restart the same operation as described at the beginning.

Except for RE17*, RE22R2MMW, RENF22R2MMW, RE22R2MMU and RE22R2MJU, timing can be interrupted / paused each time Y1 energizes.

The second output (R2) can be either timed (when set to "TIMED" or instantaneous (when set to "INST").

Function: 1 Output

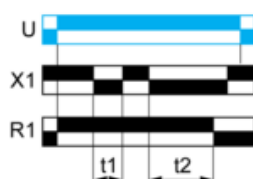

$T = t_1 + t_2 + \dots$

Function: 2 Outputs

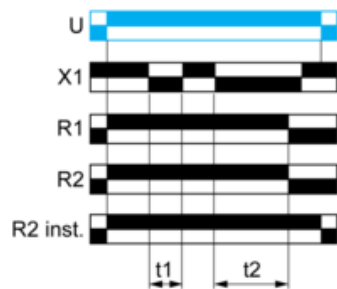

$$T = t_1 + t_2 + \dots$$

Function: 1 Output with Retrigger / Restart Control

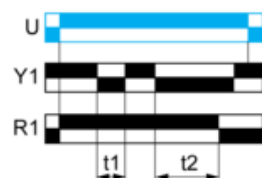

$$T = t_1 + t_2 + \dots$$

Function: 2 Outputs with Retrigger / Restart Control

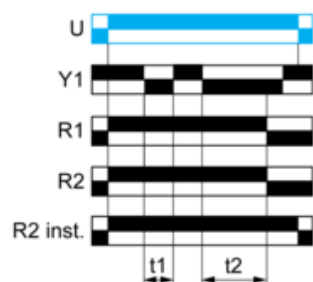

$$T = t_1 + t_2 + \dots$$

Legend

Relay de-energised

Relay energised

Output open

Output closed

C	Control contact
G	Gate
R	Relay or solid state output
R1/R2	2 timed outputs
R2 inst.	The second output is instantaneous if the right position is selected
T	Timing period
Ta -	Adjustable On-delay
Tr -	Adjustable Off-delay
U	Supply