



### Osnovne informacije

Grupa proizvoda	Harmony XVM
Pribor / posebna namena	Ø 20 mm aluminijumska cev sa metalnim nosačem
Pribor / posebna kategorija	Pribor za montažu
Pribor / posebna namena	Semafori i svetleće kolone Ø 45 mm

### Dopunske informacije

Pribor / posebni tip	Noseća cev sa nosačem
Kompatibilnost proizvoda	XVM.
Boja	Aluminijum
Visina ispod baze	113 mm
Dužina	100 mm
Masa proizvoda	0,198 kg

### Pakovanje

Unit Type of Package 1	PCE
Number of Units in Package 1	1
Package 1 Height	4,0 cm
Package 1 Width	13,0 cm
Package 1 Length	18,0 cm
Package 1 Weight	202,0 g
Unit Type of Package 2	S02
Number of Units in Package 2	15
Package 2 Height	15,0 cm
Package 2 Width	30,0 cm
Package 2 Length	40,0 cm
Package 2 Weight	3,401 kg
Unit Type of Package 3	PAL
Number of Units in Package 3	240
Package 3 Height	60,0 cm
Package 3 Width	80,0 cm
Package 3 Length	240,0 cm
Package 3 Weight	147,12 kg

## Održivost ponude

Status održive ponude	Green Premium proizvod
Propis REACH	<a href="#">REACH Deklaracija</a>
EU RoHS direktiva	Proaktivna usaglašenost (proizvod nije u zakonskom okviru direktive EU RoHS) <a href="#">EU RoHS deklaracija</a>
Bez žive	Da
Informacije o RoHS izuzecima	<a href="#">Da</a>
RoHS regulativa za Kinu	<a href="#">RoHS Deklaracija Za Kinu</a>
Izjava o zaštiti okoliša	<a href="#">Profil Ekološke Prihvatljivosti Proizvoda</a>

## Ugovorna garancija

Garancija	18 meseci
-----------	-----------

Dimensions and Mounting

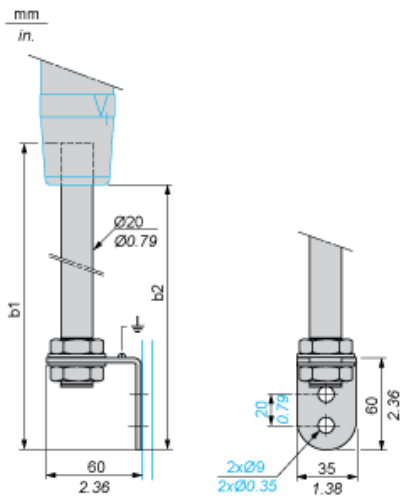

Support tube length		b1 (tube + plate)		b2 (height under base unit)	
mm	in.	mm	in.	mm	in.
100	3.94	133	5.24	106	4.17

---

Panel Cut-Out

---

